



This is a digital copy of a book that was preserved for generations on library shelves before it was carefully scanned by Google as part of a project to make the world's books discoverable online.

It has survived long enough for the copyright to expire and the book to enter the public domain. A public domain book is one that was never subject to copyright or whose legal copyright term has expired. Whether a book is in the public domain may vary country to country. Public domain books are our gateways to the past, representing a wealth of history, culture and knowledge that's often difficult to discover.

Marks, notations and other marginalia present in the original volume will appear in this file - a reminder of this book's long journey from the publisher to a library and finally to you.

Usage guidelines

Google is proud to partner with libraries to digitize public domain materials and make them widely accessible. Public domain books belong to the public and we are merely their custodians. Nevertheless, this work is expensive, so in order to keep providing this resource, we have taken steps to prevent abuse by commercial parties, including placing technical restrictions on automated querying.

We also ask that you:

- + *Make non-commercial use of the files* We designed Google Book Search for use by individuals, and we request that you use these files for personal, non-commercial purposes.
- + *Refrain from automated querying* Do not send automated queries of any sort to Google's system: If you are conducting research on machine translation, optical character recognition or other areas where access to a large amount of text is helpful, please contact us. We encourage the use of public domain materials for these purposes and may be able to help.
- + *Maintain attribution* The Google "watermark" you see on each file is essential for informing people about this project and helping them find additional materials through Google Book Search. Please do not remove it.
- + *Keep it legal* Whatever your use, remember that you are responsible for ensuring that what you are doing is legal. Do not assume that just because we believe a book is in the public domain for users in the United States, that the work is also in the public domain for users in other countries. Whether a book is still in copyright varies from country to country, and we can't offer guidance on whether any specific use of any specific book is allowed. Please do not assume that a book's appearance in Google Book Search means it can be used in any manner anywhere in the world. Copyright infringement liability can be quite severe.

About Google Book Search

Google's mission is to organize the world's information and to make it universally accessible and useful. Google Book Search helps readers discover the world's books while helping authors and publishers reach new audiences. You can search through the full text of this book on the web at <http://books.google.com/>



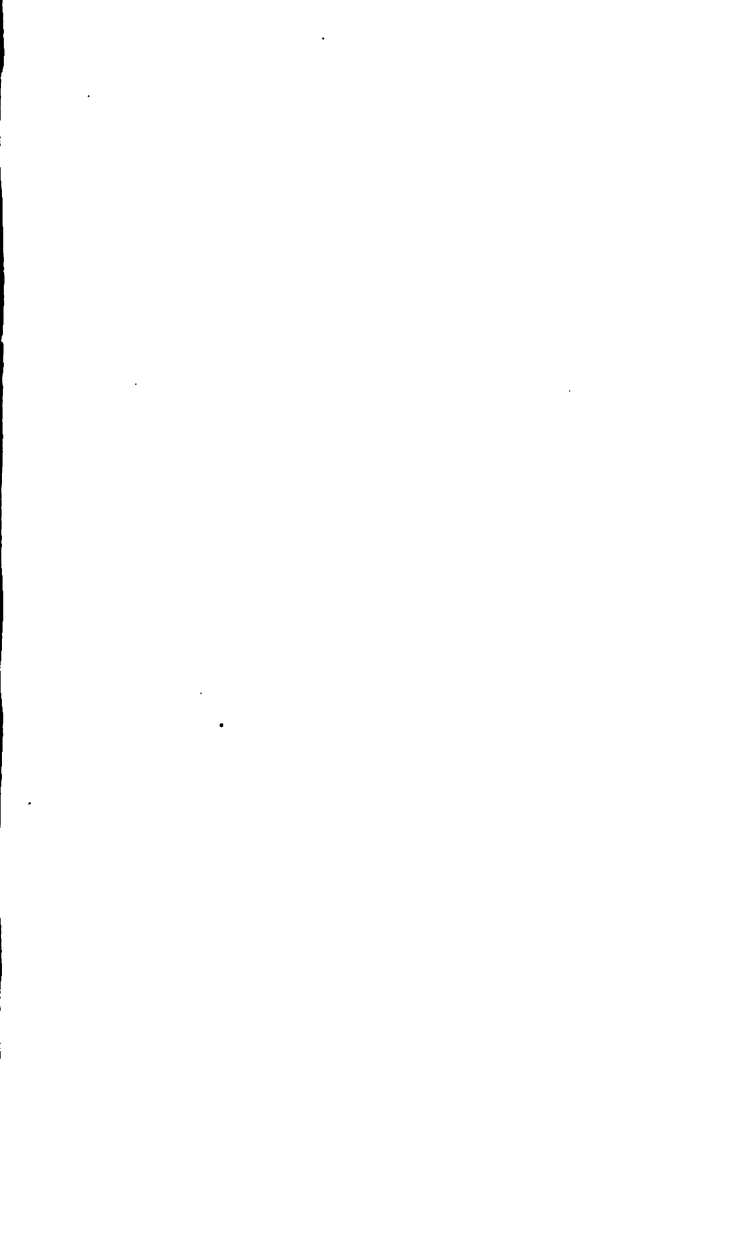

A CATECHISM

OF THE

STEAM ENGINE

IN ITS VARIOUS
APPLICATIONS TO MINES, MILLS, STEAM NAVIGATION,
AND AGRICULTURE; WITH PRACTICAL INSTRUCTIONS FOR
THE MANUFACTURE AND MANAGEMENT OF ENGINES
OF EVERY CLASS.

TO WHICH IS PREFIXED

AN INTRODUCTION DESCRIPTIVE OF ALL RECENT IMPROVEMENTS.

BY

JOHN BOURNE, C.E.

Author of

'A Treatise on the Steam-Engine,' 'A Treatise on the Screw Propeller,'

'A Handbook of the Steam-Engine,' &c.

NEW EDITION.

LONDON:

LONGMAN, GREEN, LONGMAN, ROBERTS, & GREEN.

1865.

The right of translation is reserved.

Eng 259 & 650



Brown University

LONDON
PRINTED BY SPOTTISWOODE AND CO.
NEW-STREET SQUARE

5243

259
650

TO

ANDREW LAMB, ESQ.

ENGINEER OF THE PENINSULAR AND ORIENTAL STEAM COMPANY.

MY DEAR SIR,

I inscribe the present edition of this work to you—not merely as a memorial of an intimacy which has existed during the greater part of both of our lives, but as a testimony of my appreciation of the solid and sterling qualities which have enabled you to render such important services to the Peninsular and Oriental Company, and which have had a most powerful though unseen operation in promoting the prosperity which that Company has attained. No one knows better than I do the past history of that Company, and no one is better able to appreciate the value of those momentous but unobtrusive services which have so much contributed to its success.

I remain, my dear Sir,

Very truly yours,

J. BOURNE.



PREFACE

TO

THE ELEVENTH EDITION.

THE wide circulation which my 'Catechism of the Steam Engine' has obtained entails upon me this responsibility, that I shall not suffer the information which it imparts to become antiquated, but that I shall, from time to time, so far revise its contents as to keep them in accord with the contemporaneous maxims of engineering art, and with the latest improvements in engineering practice. As this work, while descending to the apprehension of the tyro, pretends to rise to the level of the knowledge of the most proficient practitioner, it is quite indispensable, in order to justify this pretension, that it shall give the information of *to-day* rather than the information of *yesterday*; and in the present edition I have spared no pains to realise this condition of continued appreciation

and authority. I have, accordingly, not merely revised the work carefully throughout, but I have added an Introduction of nearly half the size of the work itself, in which I have endeavoured to collect all the most recent and valuable information connected with the steam engine in its present most eligible developments, to the end that the reader might be made acquainted with the last touches of improvement and the most accredited maxims of present practice. Numerous examples illustrative of recent progress in every class of engine have been introduced, so that the woodcuts in the Introduction considerably outnumber those in the original work, showing both the engineering activity of the last ten years, and the solicitude with which everything new and important has been collected.

I may here take occasion to notify that the 'Handbook of the Steam Engine,' which I have mentioned in previous prefaces as intended to contain all the rules in the 'Catechism' and some others worked out at length, with appropriate examples, I have at length been able to complete; and I trust that this work will be found to be a useful companion to the 'Catechism,' and

that it will meet with an equally wide acceptance. I have spared no pains to render it simple, reliable, and practically useful to the engineer, feeling it incumbent upon me to endeavour in some measure to justify the high expectations which the announcement of the work has raised.

J. BOURNE.

BERKELEY VILLA, REGENT'S PARK ROAD,
LONDON: 1865.



P R E F A C E

TO

THE FIRST EDITION.

THE present work is not intended as a substitute for the quarto Treatise on the Steam Engine which I lately published, but is rather to be regarded as an introduction and in some measure also as a supplement to that work. Notwithstanding the existence of the larger Treatise, it appeared to me that a work upon the steam engine, which in a moderate compass should give an outline of the whole subject in its practical aspect, would still be of much utility. There are, no doubt, many compendiums already existing which profess to accomplish this object, but I have not met with any which were calculated to satisfy even the most moderate expectations. Most of them are mere compilations from theoretical authors, and abound even with scientific errors, whilst indicating the absence of any practical acquaintance with the subject; so that they possess

but slender claims upon the attention of the engineer, or indeed of any one desirous of obtaining accurate information on the subject of which they treat. I hold it to be the first quality of an introductory work that it should at least be sound—that the doctrines it inculcates, and the lessons it conveys, shall not all have to be unlearned again at a subsequent stage of progress; and whatever be its other characteristics, I believe that the present work will at least be found to conform to this standard of utility. It embodies, I believe, the best information now existing upon the subjects of which it treats—not taken from books, nor deduced from mere theoretical considerations, but derived from my own practice or from the personal communications of the most experienced engineers of the present time.

JOHN BOURNE.

P R E F A C E

TO

T H E F O U R T H E D I T I O N .

FOR some years past a new edition of this work has been called for, but I was unwilling to allow a new edition to go forth with all the original faults of the work upon its head, and I have been too much engaged in the practical construction of steam ships and steam engines to find time for the thorough revision which I knew the work required. At length, however, I have sufficiently disengaged myself from these onerous pursuits to accomplish this necessary revision; and I now offer the work to the public, with the confidence that it will be found better deserving of the favourable acceptance and high praise it has already received. There are very few errors, either of fact or of inference, in the early editions, which I have had to correct; but there are many omissions which I have had to supply, and faults of arrangement and classification which I have had to rectify. I have

also had to bring the information, which the work professes to afford, up to the present time, so as to comprehend the latest improvements.

For the sake of greater distinctness the work is now divided into chapters. Some of these chapters are altogether new, and the rest have received such extensive additions and improvements as to make the book almost a new one. One purpose of my emendations has been to render my remarks intelligible to a tyro, as well as instructive to an advanced student. With this view, I have devoted the first chapter to a popular description of the Steam Engine — which all may understand who can understand anything — and in the subsequent gradations of progress I have been careful to set no object before the reader for the first time, of which the nature and functions are not simultaneously explained. The design I have proposed to myself, in the composition of this work, is to take a young lad who knows nothing of steam engines, and to lead him by easy advances up to the highest point of information I have myself attained ; and it has been a pleasing duty to me to smooth for others the path which I myself found so rugged, and to impart, for the general good of mankind, the secrets which others have guarded with so much jealousy. I believe I am the first author who has communicated that practical information respecting the steam engine,

which persons proposing to follow the business of an engineer desire to possess. My business has, therefore, been the rough business of a pioneer; and while hewing a road through the trackless forest, along which all might hereafter travel with ease, I had no time to attend to those minute graces of composition and petty perfections of arrangement and collocation, which are the attribute of the academic grove, or the literary parterre. I am, nevertheless, not insensible to the advantages of method and clear arrangement in any work professing to instruct mankind in the principles and practice of any art; and many of the changes introduced into the present edition of this work are designed to render it less exceptionable in this respect. The woodcuts now introduced into the work for the first time will, I believe, much increase its interest and utility; and upon the whole I am content to dismiss it into circulation, in the belief that those who peruse it attentively will obtain a more rapid and more practical acquaintance with the steam engine in its various applications, than they would be likely otherwise to acquire.

I have only to add that I have prepared a sequel to the present work, in the shape of a Hand Book of the Steam Engine, containing the whole of the rules given in the present work, illustrated by examples worked out at length, and also containing such useful tables

and other data, as the engineer requires to refer to constantly in the course of his practice. This work may be bound up with the "Catechism," if desired, to which it is in fact a Key.

I shall thankfully receive from engineers, either abroad or at home, accounts of any engines or other machinery, with which they may become familiar in their several localities; and I shall be happy, in my turn, to answer any inquiries on engineering subjects which fall within the compass of my information. If young engineers meet with any difficulty in their studies, I shall be happy to resolve it if I can; and they may communicate with me upon any such point without hesitation, in whatever quarter of the world they may happen to be.

• JOHN BOURNE.

9. Billiter Street, London.

March 1st, 1856.

PREFACE

TO

THE FIFTH EDITION.

THE last edition of the present work, consisting of 3500 copies, having been all sold off in about ten months, I now issue another edition, the demand for the work being still unabated. It affords, certainly, some presumption that a work in some measure supplies an ascertained want, when, though addressing only a limited circle — discoursing only of technical questions, and without any accident to stimulate it into notoriety, — it attains so large a circulation as the present work has reached. Besides being reprinted in America, it has been translated into German, French, Dutch, and I believe, into some other languages, so that there is, perhaps, not too much vanity in the inference that it has been found serviceable to those perusing it. I can with truth say that the hope of rendering some service to mankind,

in my day and generation, has been my chief inducement in writing it, and if this end is fulfilled, I have nothing further to desire.

I regret that circumstances have prevented me from yet issuing the "Hand-Book" which I have had for some time in preparation, and to which, in my Preface of last year, I referred. I hope to have sufficient leisure shortly, to give that and some other of my literary designs the necessary attention. Whatever may have been the other impediments to a more prolific authorship, certainly one of them has not been the coldness of the approbation with which my efforts have been received, since my past performances seem to me to have met with an appreciation far exceeding their deserts.

JOHN BOURNE.

February 2nd, 1857.

CONTENTS.



INTRODUCTION TO CATECHISM OF THE STEAM ENGINE.

	PAGE OF INTRODUCTION
Thermo-Dynamics - - - - -	2
Superheating - - - - -	5
High Pressure, Expansion, and Surface Condensation - -	13
Combined Screw and Paddle Engines - - - - -	24
Modern Forms of Screw Engines - - - - -	25
On balancing the Momentum of Engines - - - - -	26
Marine Governors - - - - -	27
Balanced Valves - - - - -	30
Link Motion - - - - -	31
Starting Cylinders and Valves - - - - -	33
Shafts and Shaft Bearings - - - - -	35
Actual and Nominal Horses' Power - - - - -	38
Modern Forms of Boilers - - - - -	41
Proportions of Boilers - - - - -	48
Smoke Burning - - - - -	53
On the Resistance of Ships - - - - -	54
Double Screws - - - - -	57
Various Forms of Screw - - - - -	57
Land Engines - - - - -	58
Giffard's Injector for Feeding Boilers - - - - -	102
Marine Engines - - - - -	111
Locomotive Engines - - - - -	133
Coal-burning Locomotives - - - - -	135
Foreign Goods Locomotive - - - - -	143
Standard Forms of English Locomotives - - - - -	160
Details of Modern Locomotives - - - - -	177

	PAGE OF INTRODUCTION
Locomotives for Running on Ice - - -	- 191
Locomotives for Common Roads - - -	- 192
Ploughing by Steam - - -	- 207
Steam Fire Engines - - -	- 217
Ice made by Steam - - -	- 237

CATECHISM OF THE STEAM ENGINE

	PAGE OF CATECHISM
Classification of Engines - - -	- 1
Nature and Uses of a Vacuum - - -	- 4
Velocity of falling Bodies and Momentum of moving Bodies - - -	- 8
Central Forces - - -	- 12
Centres of Gravity, Gyration, and Oscillation - -	- 15
The Pendulum and Governor - - -	- 17
The Mechanical Powers - - -	- 22
Friction - - -	- 26
Strength of Materials and Strains subsisting in Machines -	33

CHAP. I.

GENERAL DESCRIPTION OF THE STEAM ENGINE.

The Boiler - - -	- 45
The Engine - - -	- 53
The Marine Engine - - -	- 65
Screw Engines - - -	- 74
The Locomotive Engine - - -	- 80

CHAP. II.

HEAT, COMBUSTION, AND STEAM.

Heat - - -	- 87
Combustion - - -	- 90
Steam - - -	- 104

CHAP. III.

	PAGE OF CATALOGUE
EXPANSION OF STEAM AND ACTION OF THE VALVES	- 111

CHAP. IV.

MODES OF ESTIMATING THE POWER AND PERFORMANCE OF
ENGINES AND BOILERS.

Horses Power	- 131
Duty of Engines and Boilers	- 139
The Indicator	- 144
Dynamometer, Gauges, and Cataract	- 151

CHAP. V.

PROPORTIONS OF BOILERS.

Heating and Fire Grate Surface	- 157
Calorimeter and Vent	- 161
Evaporative Power of Boilers	- 169
Modern Marine and Locomotive Boilers	- 172
The Blast in Locomotives	- 174
Boiler Chimnies	- 180
Steam Room and Priming	- 183
Strength of Boilers	- 189
Boiler Explosions	- 195

CHAP. VI.

PROPORTIONS OF ENGINES.

Steam Passages	- 201
Air Pump, Condenser, and Hot and Cold Water Pumps	- 207
Fly Wheel	- 216
Strengths of Land Engines	- 216
Strengths of Marine and Locomotive Engines	- 223

CHAP. VII.

CONSTRUCTIVE DETAILS OF BOILERS.

	PAGE OF CATECHISM
Land and Marine Boilers - - -	- 231
Incrustation and Corrosion of Boilers - -	- 246
Locomotive Boilers - - -	- 261

CHAP. VIII.

CONSTRUCTIVE DETAILS OF ENGINES.

Pumping Engines - - -	- 271
Various Forms of Marine Engines - -	- 282
Cylinders, Pistons, and Valves - - -	- 288
Air Pump and Condenser - - -	- 299
Pumps, Cocks, and Pipes - - -	- 310
Details of the Screw and Screw Shaft - -	- 317
Details of the Paddles and Paddle Shaft -	- 321
The Locomotive Engine - - -	- 330

CHAP. IX.

STEAM NAVIGATION.

Resistance of Vessels in Water - - -	- 359
Experiments on the Resistance of Vessels -	- 363
Influence of the Size of Vessels upon their Speed	- 368
Structure and Operation of Paddle Wheels -	- 369
Configuration and Action of the Screw - -	- 378
Comparative Advantages of Paddle and Screw Vessels	- 383
Comparative Advantages of different Kinds of Screws	- 394
Proportions of Screws - - -	- 402
Screw Vessels with full and auxiliary Power -	- 405
Screw and Paddles combined - - -	- 407

CHAP. X.

EXAMPLES OF ENGINES OF RECENT CONSTRUCTION.

				PAGE OF CATALOGUE
Oscillating Paddle Engines	-	-	-	411
Direct acting Screw Engine	-	-	-	483
Locomotive Engine	-	-	-	447

CHAP. XI.

ON VARIOUS FORMS AND APPLICATIONS OF THE STEAM
ENGINE.

Portable Agricultural Engines	-	-	-	455
Fixed Agricultural Engines	-	-	-	476

CHAP. XII.

MANUFACTURE AND MANAGEMENT OF STEAM ENGINES.

Construction of Engines	-	-	-	505
Erection of Engines	-	-	-	519
Management of Marine Boilers	-	-	-	528
Management of Marine Engines	-	-	-	534
Management of Locomotives	-	-	-	539

INTRODUCTION
TO
CATECHISM OF THE STEAM ENGINE.

In this Introduction I propose to recapitulate the most useful information I have been able to collect respecting the improvements which have been made in the steam engine during the last decennium.

As this work addresses practical engineers, and not mere desultory or superficial enquirers, it is indispensable that the information it affords should not only be intrinsically sound and practical, but that it should be cleared of all tinge of antiquity. In an art so rapidly progressive as mechanical engineering, the knowledge of ten years ago is no longer adequate to satisfy the wants or direct the operations of present practice; and, under this conviction, it has appeared to me that the time has come when it would be proper to review the information which the present work contains, in order that it might be rendered more conformable to the accredited maxims of the time, and also that reliable information respecting altered modes and new improvements might be fully afforded. To this end I have carefully revised the text of the last edition; and I have introduced such alterations into it as appeared to me to be necessary to make the

work consistent with the best indications of modern practice. But these alterations have not been numerous or extensive, as I found that although there was a good deal to add there was little to alter; and it seemed to me that the requisite additions could be much more conveniently made in a separate discourse, which would be introductory to the work, and which might be purchased separately by the possessors of the former editions, than by incorporating such new information in the body of the work itself, whereby it would be rendered inaccessible to all who did not feel disposed to purchase the entire volume. Under these convictions I have proceeded to prepare the present introduction; and I trust that it will be found to answer its intended purpose of giving an accurate and vigorous outline of contemporaneous engineering knowledge in its most select manifestations, and that it will set the reader face to face with the works and opinions of those who are justly accounted the leaders of the art, so that he will be able to feel that he has been brought up to the highest point of information yet reached by the most eminent practitioners. It is this vitalizing species of knowledge which alone renders engineering works of much value; and the place of it can never be supplied by the resources of abstract speculation, or the pale reflections of the literary compiler.

THERMO-DYNAMICS.

One of the ablest series of researches which has been made of late years on subjects connected with

steam, is that by which Mr. Joule has established the mutual relations of heat and power. It has long been known that heat may be made to produce power, and that power may be made to produce heat. But Mr. Joule has shown by elaborate experiments that the heat produced by friction is the mechanical equivalent of the power expended in maintaining the friction; and that the power represented by the descent of a pound weight through 772 feet, or 772 lbs. through one foot, would, if expended in friction, produce as much heat as would raise the temperature of a pound of water one degree Fahrenheit. If we had a perfect engine for extracting the power from heat, we ought to be able to recover from the heat generated by friction the exact amount of power expended in generating the heat. But in the best existing steam engines it is found that only about *one tenth* of the value of the heat is obtained as power, the residue being wholly wasted; so that if a steam engine were employed to generate heat by friction, only one tenth of the power would be obtained that would have to be consumed in the production and maintenance of the friction. The steam engine, indeed, has now been found to be a very wasteful machine; and the cause of the waste is traceable to the fact that it deals with extremes of temperature but little removed from one another, instead of with extremes of temperature as far removed from one another as possible. As in a waterfall the power generated with any given quantity of water is measurable by the difference of level between the highest and the lowest points, so

in a steam engine the power generated with any given quantity of heat is measurable by the difference of temperature between the boiler and the condenser. The greater this difference is, the larger will be the proportion of heat utilized as power. But as in common furnaces the temperature may be taken at 3,000 degrees above the temperature of the atmosphere, while the temperature of the boiler is only about 200 degrees above the temperature of the condenser, the larger part of the fall in the temperature is lost, or not utilized, and the engine is consequently not nearly so effective as it would be if the steam could be received at the temperature of the furnace and expanded down to the temperature of the condenser. In practice there are impediments to the use of steam hotter than that which is at present employed. But it is, nevertheless, proper to understand that either a very much higher initial temperature must be dealt with, or else the combination of the fuel with oxygen must be conducted under such circumstances as to generate power rather than heat, before that measure of economy in the production of power can be attained which is known to be possible. In the animal economy a given quantity of carbon produces its equivalent of power with far less waste than in the best steam engine, although the temperature is not great: and the same result takes place in a Voltaic battery—the electricity generated by which may be made to work an engine with far less loss than its equivalent quantity of heat. It does not, however, appear to be in the least probable that electro-magnetic engines will be brought into use to

supersede steam engines, unless some means should be discovered of obtaining the electricity from coal instead of zinc. Zinc, like coal, may be burned, and will produce heat. But a pound of coal consumed in an engine will produce more than twice the power produced in a Galvanic battery by a pound of zinc, and the cost of the coal will also be very much less.

SUPERHEATING.

The practice of superheating the steam before permitting it to enter the engine is now very generally pursued, especially in steam vessels; and the innovation has been productive of a material saving of fuel in many cases. The reasons which render superheating a source of economy may be inferred from the foregoing remarks on Thermo-dynamics; and in the first edition of my Treatise on the Steam Engine, published in 1844—which was long before the benefits of superheating were recognized—an investigation was given of the economy to be derived from a certain assigned amount of superheating. This investigation was first made by me in 1834, and subsequent experience has shown that the estimate then arrived at was pretty nearly correct. It was, however, at the same time, pointed out by me in the Treatise on the Steam Engine, and also in the first edition of the Catechism of the Steam Engine, published in 1848, that the expedient of superheating would, no doubt, lead to the internal corrosion of the superheating vessel, and also of the internal parts of the engine; and this anticipation has also been

verified by the result.* It is found in practice that if the steam is superheated to a temperature exceeding 315 degrees, the hemp packings of the stuffing boxes will be burned, the oil or tallow used in the engine will be carbonized, and the cylinders and valves will be liable to be grooved and injured by the heat and friction of the rubbing parts. In boilers already producing dry steam, and possessing an adequate amount of heating surface, the saving in coal accomplished by superheating common low pressure steam to this extent may be set down as about 10 per cent.; and although a larger economy than this has been obtained in some cases, the increased advantage is to be imputed to the acquisition of an increased heating surface, whereby the heat has been utilized in drying the steam that previously

* When the first edition of the present work appeared in 1848, the practice of transmitting the smoke through the steam chest in marine boilers was universal; and it will be seen at p. 257 that I reprehended that practice as certain to occasion internal corrosion of the steam chest, and I recommended that the smoke should be transmitted to the exterior of the boiler without being passed through the steam chest at all. This recommendation appears to have been adopted, as the smoke is rarely, if ever, now transmitted through the steam chest; and the internal corrosion of the steam chest has consequently ceased to be a source of injury. But where superheaters are employed the same internal corrosion which was formerly experienced in the steam chest reappears in the superheater—though, as this is a removable vessel, and one from which the steam can at any time be shut off, the evil of internal corrosion is not so serious when occurring there, as if it took place in the boiler itself.

I believe that the internal corrosion of superheaters might be prevented by placing pieces of charcoal within them, either in a wire cage or otherwise, for the carbon would satisfy the affinity of the oxygen which now produces oxidation, and would thus leave the iron free from attack.

ascended the chimney—rather than to the superior efficacy of a given quantity of heat when distributed in the assigned proportion between the water and the steam.* Upon the whole, superheating is now rather on the decline; at all events, it is not now carried much beyond that point which suffices to dry the steam, and to prevent the steam within the cylinder from suffering partial condensation, either by external radiation or by the generation of power.†

* In some cases where a large amount of advantage has been obtained from the application of superheaters, although the steam has not been heated to any inconvenient temperature, a part of the benefit is explicable on the supposition that the steam which was before mixed with spray has been dried in the superheater, whereby its volume has been much augmented although its temperature has not been very much raised. This benefit is manifestly a different one from that of superheating proper, and in a boiler already producing dry steam it would not be obtained.

† Steam in the production of power is itself condensed; and less heat will pass into the condenser than is generated in the boiler by the amount that is the equivalent of the power generated. If this were not so, a steam-engine would be a heat-producing engine; for the power of the engine is capable of producing heat by friction, and if we had in the condenser all the heat which the coal can generate, and if we also had the heat generated by the friction, we should have a total amount of heat greater than the coal could generate, which is an absurd supposition. There will consequently always be in the condenser less heat than the boiler produces; and the greater this disparity—supposing there is no loss by radiation—the more effective the engine will be. In a perfect engine the temperature of the condenser would not be raised at all; but the heat would wholly disappear by its transformation into power. In such an engine the steam would enter the cylinder at the temperature of the furnace; and as it expanded more and more, its temperature would fall more and more, until finally it entered the condenser at the same temperature as the condenser itself. Such an engine indeed would not require a condenser, since the steam would itself condense as the heat left it by its transformation into power.

But condensation is equally hindered by the application of a steam jacket; and high-pressure steam worked expansively in jacketed cylinders, combined with surface condensers in the case of steam vessels using salt water, is now regarded as the most promising expedient of economy.

The construction of superheaters is very various. But in most cases the steam is sent through a faggot of small tubes set in the smoke at the root of the chimney.

An example of this arrangement is given in *fig. 1*, which is a representation of the superheater introduced by Messrs. R. Napier and Sons into the steamer 'Oleg,' belonging to the Russian Steam Navigation Company. *A* is the boiler, and *a* the uptake of the boiler; *d* position of inlet valve connecting boiler with superheater; *D* and *F* inlet and outlet chambers of superheater; *E* tubes through which the steam passes; *g* double outlet stop-valve chest, in which *g* connects superheater to steam pipe, and *h* connects boiler to steam-pipe direct. *H* is the chimney. The smoke in ascending the chimney impinges on the tubes transmitting the steam, whereby the steam is heated to the required extent.

In Lamb and Summers' superheating arrangement, a narrow rectangular pipe or chamber—which winds in a zigzag manner like the flue of a flue boiler—conducts the steam backwards and forwards amongst the smoke at the root of the chimney, until finally the steam debouches in the steam pipe.

This superheater is shown in *fig. 2*, where *A* is the winding rectangular chamber; *B* the stop valve

for admitting steam into the superheater; C stop-valve for letting steam pass from the boiler to the

Fig. 1.

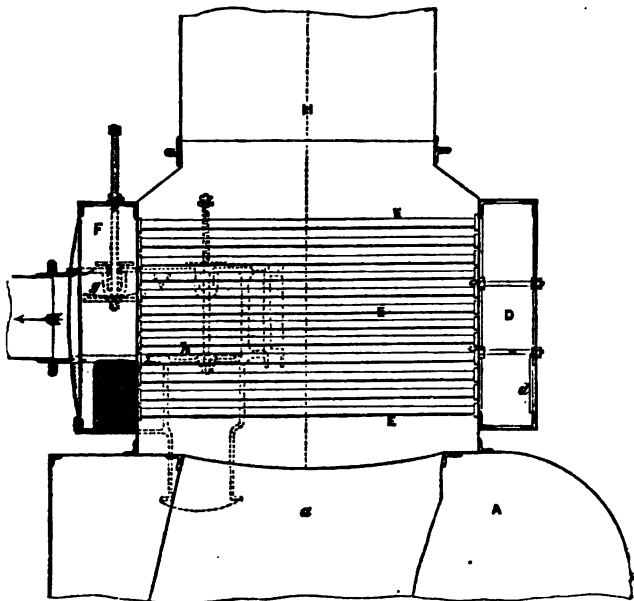

SUPERHEATING APPARATUS OF S. S. OLEG, BY R. NAPIER AND SONS. 1860.
Longitudinal Section.

engines without passing through superheater; D stop-valve for shutting off superheater; G is the chimney; F is a door for getting into it, and H H is a ring or cooming, over which the chimney passes, and the

10 RECENT IMPROVEMENTS IN THE STEAM ENGINE.

space between which and the chimney is filled with fire-clay to keep it tight.

Fig. 2.

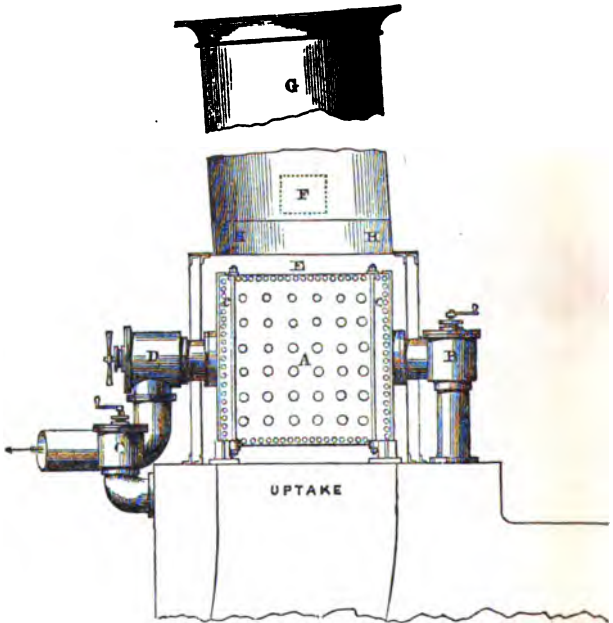

LAMB AND SUMMERS' SUPERHEATING APPARATUS, 1860. Vertical Section.

Another example of Lamb and Summers' superheater is given in *fig. 3*, which is a ground plan of the superheater as applied to four boilers, collectively of 400 horse power. The steam space is 4 inches

wide, and the smoke spaces are each $6\frac{1}{2}$ inches wide. The winding length through which the steam is conducted is 51 feet 9 inches, and the height of the

Fig. 3.

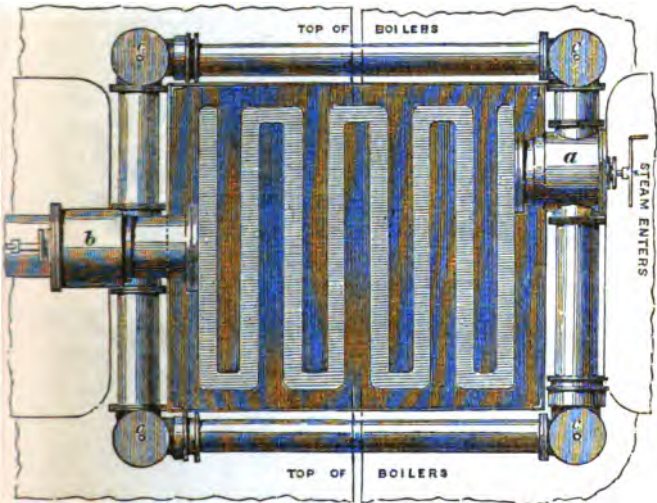

LAMB AND SUMMERS' SUPERHEATING APPARATUS, 1865. Ground Plan.

winding chamber is 5 feet 7 inches. The total area of heating surface in the superheater is 600 square feet, which is just $1\frac{1}{2}$ square feet per nominal horse power. The steam issues from the boiler through the stop-valves *c c c c*, enters the superheater through the stop-valve *a*, and escapes through the stop-valve *b*.

Another form of superheater is shown in *fig. 4*, which is the superheater constructed by Messrs. Boulton and Watt for the steamer Great Eastern.

Fig. 4.

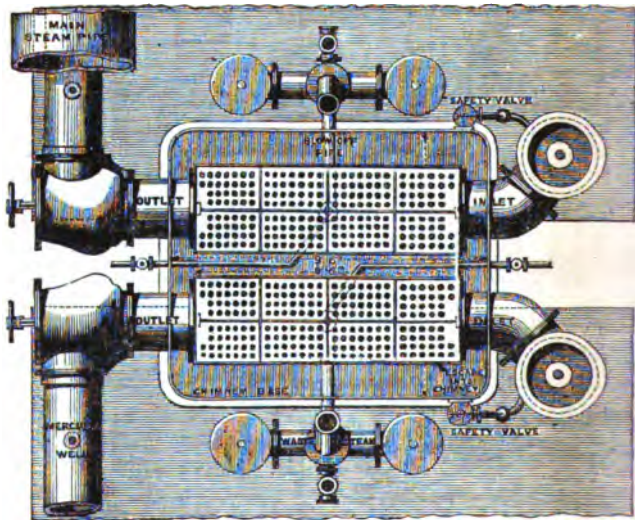

SUPERHEATING APPARATUS OF GREAT EASTERN, BY BOULTON, WATT, AND Co. Ground Plan.

This superheater consists of a square chest placed over the uptake at the foot of the chimney, and filled with vertical pipes through which the smoke passes. In this case the steam passes on the outside of the tubes, whereas in most cases it passes through the tubes as shown in *fig. 1*.

A common proportion of surface given to superheaters is 4 square feet per nominal horse power. But this is quite too much, and $1\frac{1}{2}$ square feet per nominal horse power is sufficient. As, however, the nominal horse power is so indefinite a quantity as regards the boiler, it will be preferable to fix the surface of the superheater at .3 square feet per cubic foot of water evaporated. It is of course necessary to be careful in introducing superheaters not to contract the area for the ascent of the smoke up the chimney, which should be left quite as large as before.

HIGH PRESSURE, EXPANSION, AND SURFACE CONDENSATION.

The use of a high-pressure of steam worked expansively is now beginning to acquire general acceptance in every class of engines; but, in steam vessels, the use of steam of any considerable pressure involves the necessity of employing surface condensers, so that the boilers may be fed with fresh water, as where salt water is used there is always the risk of salting; and if a boiler with a high-pressure of steam were to be salted up, so as to become red hot, it would probably burst. I have long discerned the importance of this combination for the purposes of steam navigation; and in 1838 I took out a patent for using high-pressure steam expansively in steam vessels, in which plan the feature of external condensation was introduced. The boiler proposed to be used, and which was practically constructed by

me at that time, was a cylindrical one, and it was traversed by brass tubes $2\frac{1}{2}$ inches in diameter, being the first example, so far as I am aware, of a tubular boiler like that of a locomotive applied to the purposes of steam navigation. The steam was proposed to be used expansively, and was cut off by a slide valve formed of two moveable plates worked on the back of the common slide valve; and the degree of expansion was regulated by a right and left-hand screw, which drew the plates nearer together, or separated them wider apart, according as much or little expansion was desired. The spindle on which the screws were cut passed through a stuffing-box, and was armed at the top with a small wheel, by turning which the amount of the expansion was determined. This was the first example, I believe, of a class of expansion valve much employed by Meyer of Vienna and many other Continental engineers, and which indeed has now come into extensive use both abroad and at home.

The steam under the arrangement recited was proposed to be condensed by being sent through a number of small copper tubes immersed in cold water. This method of condensation had been originally employed by Watt, but was dismissed by him on account of the cumbrous nature of the apparatus it involved, without conferring compensating benefit; and it was afterwards revived by Samuel Hall, about 1835, as an expedient for rendering marine boilers less subject to rapid decay than at that time they were found to be. But as Hall's condenser was not found to increase the durability of the boilers, it

was discarded as an unserviceable innovation, which would hardly have been its fate if it had been combined with the use of high pressure steam, and if it had been shown that its employment was necessary to enable high pressure steam, with its concomitant benefits, to be applicable with safety. For many years, however, there was a marvellous apathy among the proprietors of steam engines regarding the consumption of fuel, except in Cornwall, where the system which prevailed of ascertaining and publishing the consumption of a great number of engines induced corresponding emulation and improvement. But the conviction has at length dawned upon us that in the case of all processes requiring a large expenditure of power, and especially in the case of steam navigation, the difference between a large and small consumption of fuel is so momentous that it may determine the success or failure of the speculation; and surface condensation is now very properly regarded not as a primary source of gain, but as an expedient for saving fuel by enabling steam of a high pressure to be used in steam vessels with safety. The surface condensers are nearly in all cases formed with small brass or copper tubes, and these tubes are sometimes drawn out of the solid, and sometimes formed out of brass or copper sheets brazed. The tubes with the brazed joints are, on the whole, the best, as in the drawn tubes the smallest speck in the metal is drawn out or elongated into a crack; and such tubes are consequently more liable to split. In some cases the water is sent through the tubes and in other cases the steam; but, on the whole, the best

practice is to send the water through the tubes; and the steam should enter at the opposite side from the water, so that the hottest steam may meet the hottest water. The proportion of condensing surface commonly allowed for each nominal horse power varies from 12 to 18 square feet, and some engineers maintain that there should be as much cooling surface in the condenser as there is heating surface in the boiler—a conclusion from which I dissent altogether. I believe that 10 square feet per nominal horse power would be more than sufficient in all ordinary cases, if the surface were properly disposed, and a rapid circulation of the refrigerating water were maintained; and indeed in a really well-constructed condenser, employing a small jet, I feel persuaded that 1 square foot of condenser surface for each cubic foot evaporated from the boiler would be sufficient. The main condition of efficiency in condensers is the maintenance of a very rapid circulation of water through the tubes. The usual arrangement is to place the tubes horizontally in a square box, and to bring in the water at the bottom of the box, and the steam at the top. The water frequently passes through one-third of the tubes at first, and is then returned through another third lying immediately above, and finally through the third portion, so that the hottest water meets the entering steam. But in scarcely any condenser is the circulation rapid enough, and it is much better to have a little more area in the circulating pump, which will save surface in the condenser.

In Hall's condensers a good deal of trouble was at

first experienced from the tallow supplied to the piston and stuffing boxes being distilled over with the steam and concreting in the tubes, so as to choke them up; and in consequence of this occurrence oil was finally used for the pistons and stuffing boxes instead of tallow. The same inconvenience has recurred in some of the recent surface condensers; and in engines furnished with such condensers it appears advisable to use oil instead of tallow, and also to use as little of it as possible. It is further advisable to feed the oil to the stuffing boxes and pistons continuously, by some such arrangement as it is fed to the bearings by, as the necessary amount of lubrication will be thus given with the least oil.

Where hot steam is employed in jacketed engines, and much tallow is introduced, it is found that the tallow is decomposed, and carbonises the piston; so that after a time the piston becomes like a piece of plumbago, or like cast iron which has been long immersed in sea water, and which finally becomes so soft that it may be cut by a knife. It is further found that instead of the surface condensers conducing to the durability of the boilers, they have the very reverse operation, and that it is necessary to introduce a certain proportion of salt water from the sea to prevent the boilers from being rapidly destroyed. Not only is the grease from the engine carried into the tubes of the condenser, but a certain proportion of it passes into the boiler; and the verdigris formed by the action of the grease upon the brass or copper tubes also distils over and attacks the surface of the iron within the boiler, so that in a short

time it is eaten into pits and indentations, and becomes covered with an efflorescence of red rust. The presence of pieces of zinc within the boiler would probably hinder or retard this action; but the best antidote appears to be the introduction of a small jet of salt water into the condenser, which, if employed while the boiler is still new, will have the effect of covering the flues with a thin enamel of scale.* There should be no means of shutting off any of the surplus water thus introduced; but the surplus should escape spontaneously when the level becomes too high. The application of such a jet, moreover, will, if judiciously made, enable the refrigeratory surface of the tubes to be very much reduced, as the tubes will only be required to condense the hotter part of the steam, while the vapour may be condensed by the supplementary jet, if it is introduced at the proper place.

The introduction of surface condensers into ocean vessels performing long voyages has revealed many weaknesses of the system which are no doubt superable. But the conviction arises that the remedy may come too late; and it is exceedingly doubtful whether surface condensers will succeed in maintaining the ground they at present occupy. The experience of the corrosive action of such condensers on the boilers

* New boilers should be worked wholly with salt water at first, until a scale forms upon them. The sulphate of lime in sea water is deposited at the temperature due to the pressure of three atmospheres *without any concentration at all*; so that with high-pressure steam in boilers using salt water, the more blowing-off there is, the more deposit there will be.

is universal; and in some cases, where the boiler has been worked with salt water after the corrosive action had set in, the scale purposely produced from the salt water could not be got to adhere solidly to the iron, but when struck it fell off in flakes, revealing a thick coating of rust below. In such cases it has been found advisable to beat off all the rust and scale, and to cover the interior of the boiler with a thin coating of Scott's cement; after which it was found that the scale would permanently adhere. The water of boilers using surface condensers becomes in time of a bluish hue—a phenomenon due partly perhaps to the carbonisation of the oil or tallow which the water resulting from the condensation brings into the boiler with it, and partly to the distilled verdigris. I see no reason to doubt that practical objections such as I have here enumerated, which are the natural incidents of all innovation, will in time be surmounted. But I am not equally confident that the time for surface condensation has not gone by. Thirty, or even twenty years ago, the practical establishment of the system in connexion with high steam and expansive action, would have been a practical benefit. But the method I have since suggested for maintaining any desired amount of freshness in the water of the boiler without any material waste of heat in blowing off, constitutes an alternative method, which, by conferring most of the benefits of surface condensation without the evils, subverts the ground on which the system of external condensation rests, so that, like many other tardy realisations, it now comes too late. The sulphate of lime may be obstructed by filtration or deposition in a separate vessel

heated to the temperature required, to ensure the separation of the lime.

When surface condensers are used, it is the best arrangement with reciprocating pumps, to *draw* the water through the tubes, rather than to *force* it through. The circulation should be very rapid, and all the arrangements should be such as to enable the condenser to be converted at once into an ordinary condenser, should any circumstance occur to render the transformation advisable. In America a form of condenser is sometimes used in which there is a vacuum both within and without the tubes, under which arrangement the tubes may be very thin, as there is no pressure upon them.

The tubes of surface condensers are usually half or five-eighths of an inch in diameter, and from five to seven feet long. But it is better to make them shorter and larger in diameter. They are sometimes fixed in with a brass screw—with a linen washer below, so as to form a gland at the end of each tube—the screw being screwed into the tube plate; and at other times the whole end of the barrel or case containing the tubes is covered with a sheet of india rubber, perforated to let the tubes through, and with a metal plate, similarly perforated but with somewhat smaller holes, screwed down on the india rubber. This last is the simplest arrangement, and it is now widely adopted.

The species of condenser proposed by me as a substitute for surface condensers, consists of a common condenser fitted with two jets, one of which is placed in the eduction pipe, or very high up in the condenser; and

the other about the centre of the condenser. The water which enters by the highest jet, and which the steam first encounters, is not sufficient fully to condense the steam, but is itself heated to the boiling point—in which state it is withdrawn to feed the boiler; and this boiling feed, being in excess of the requirements of the boiler, and being purposely so arranged that it cannot be shut off, involves the necessity of a large amount of continuous blowing off. It is obvious that in this arrangement the ordinary jet will condense the residue of the steam not condensed by the first jet, and will maintain the vacuum at the proper point; and this will be done with less condensing water than usual, as if some of the water is withdrawn very hot, there will be less heat remaining to be abstracted by the rest. Even in surface condensers it would be advisable to heat the feed water by injecting it into the steam entering from the eduction pipe before sending it into the boiler, as there is a manifest loss by sending the feed water into the boiler very cold, and probably a very small surface condenser with supplementary jet is the best arrangement in engines using high steam.

In some engines the circulation of the refrigeratory water through the condenser is maintained by a common double-acting pump; and in other engines the circulation is maintained by a centrifugal pump, driven in some cases by a separate small engine, and in other cases by gearing. In some arrangements the ordinary air pump of one of the engines is used as a circulating pump for both of the engines, and the air pump of the other engine is used as an air

pump for both the engines. When a centrifugal pump is used, it appears to be the best arrangement to drive it by a separate donkey engine, the speed of which may be varied as desired, and which engine may also be made to drive the supplementary feed and bilge pumps.

The question of the most eligible method of working steam expansively, especially in steam vessels, has now become of much interest; and various forms of double cylinder engines have been put forth, professing to satisfy the conditions of the problem. But it may safely be asserted, that for all pressures employed in the ordinary class of existing steam vessels, engines of the common single cylinder type are as efficient as any other; and in practice such engines are found to work quite as economically as engines with any greater number of cylinders, while they are manifestly simpler in construction. The first question that presses for solution in the case of steam vessels is, what kind of boilers shall be used that will be strong enough to withstand a high pressure of steam with safety; seeing that the ordinary marine boilers at present employed are quite too weak for higher pressures than those which they are at present constrained to bear. For pressures up to 30 or 40 lbs. per square inch, engines of the common type, with a length of stroke equal to the diameter of the cylinder, will answer very well. But if the pressure be raised to 60 or 70 lbs. per square inch, it will be advisable to double the length of the stroke and halve the area of the piston; so that the maximum pressure on the piston will only be the same

as before, but the velocity of its motion will be doubled. In this increase of the velocity of the piston, there will be no disadvantage if the momentum be balanced by suitable counterweights attached to the cranks, and if the cylinder ports are made as large for the long and narrow cylinder as for the short and wide one. If such pressures be employed as 150 or 200 lbs. per square inch, it may be proper to introduce double cylinder engines. But the use of a long stroke is tantamount to the employment of double cylinders, in so far as it reduces the maximum pressure on the piston; and it is proper to exhaust the resources of single cylinder engines by suitably modifying the proportions to answer the intended amount of expansion, before entering on the ineligible complication of a multiplication of the number of cylinders. All engineers perfectly well know that the gain in power producible by a given amount of expansion is equally attained whether such expansion is accomplished in one cylinder or in fifty. But the more cylinders there are, the more equable will the pressure be made throughout the stroke—at the same time that there will be greater complication. The equalisation of the pressure, however, may be promoted by increasing the length of the stroke, which is a simpler expedient than increasing the number of cylinders; and in steam vessels great equality of the pressure is not important, while in land engines it may be attained to any desired extent by increasing the weight and swiftness of the fly-wheel. I do not by any means object to double cylinder engines *in toto*. I only say that they should not be

introduced for nothing ; and if they *are* introduced, such an increased pressure of steam should be introduced simultaneously as will afford fair compensation and proper warrant for the increased complication which the innovation involves.

COMBINED SCREW AND PADDLE ENGINES.

In 1850, when it became important to accelerate the speed of a fleet of paddle vessels, I suggested a method of accomplishing the required acceleration, without disturbing the existing engines, by the application of an independent high-pressure engine in each vessel, which was to drive a screw placed at the stern ; and the steam from this high-pressure engine was subsequently to pass to the paddle engines, and to drive them with the same pressure as that to which they had previously been subjected. This arrangement was virtually that of a double cylinder engine, for the steam was used twice over ; and although the complication was greater than it might have been advisable to incur in new engines, it was excusable under the circumstances, as it afforded the means of accomplishing the desired acceleration with the least disturbance of the existing arrangements, and also at a trifling expense. I reckoned that each vessel, when laden for her intended voyage, after having been fitted with the auxiliary engine, would have been lighter than before ; as, although the weight of the machinery would have been greater, the weight of the coals would have been less. By this expedient the power might have been nearly

doubled without any increased consumption of coal per hour; and as by doubling the power, the speed would have been rendered one-fourth greater, almost one-fourth of the coal would have been saved on the voyage.

In 1852 the foregoing suggestion was published in my 'Treatise on the Screw Propeller,' and shortly afterwards it was announced that the Great Eastern was to be propelled by paddles and a screw. I do not recommend the plan for new vessels. But I consider the introduction of a duplicate high-pressure engine, with a separate propeller, to be the most eligible means of accelerating old vessels, whether paddles or screws. In paddle vessels a single direct-acting high-pressure engine driving a screw—which may be placed outside the rudder as in Beattie's plan—the steam from this engine passing subsequently to the paddle engines and driving them—is an arrangement that is cheap, easily applicable, and certain to be effective. In screw vessels a single high-pressure paddle engine may in like manner be set to drive a pair of paddles; and the steam from this engine would drive the ordinary screw engines as effectively as if they were supplied with steam direct from a low-pressure boiler. I believe that this form of the double cylinder engine is likely to be introduced in all cases in which it is considered desirable to obtain more speed in existing vessels with less coals.

MODERN FORMS OF SCREW ENGINES.

Geared engines for driving the screw have now practically gone out, as I have long foreseen would

be the case; and the species of horizontal steeple engine of some such construction as that described at page 433 of my Catechism of the Steam Engine, and recommended in the early editions of that work, is now the species of screw engine employed by the most eminent constructors. The class of engines called 'Forge Hammer Engines,' in which two or more inverted cylinders are raised high upon framing, and the connecting rod engages the crank beneath, is still used by some makers; and in many cases—and especially if the engines are of no great dimensions—they have been found to work very satisfactorily. But on the whole, the horizontal steeple engine is preferred; and some class or other of horizontal direct acting engine is now used by Messrs. Penn, Maudslay, Ravenhill, Napier, Rennie, and indeed by all the most eminent engineers. A little further on I will give illustrations of some of the best existing examples of screw engines.

ON BALANCING THE MOMENTUM OF ENGINES.

The application of balance weights to the cranks of direct-acting screw engines, is now a very general practice; and it is found to conduce to the easy and steady working of the engines in a very marked manner. This application was first made by myself; and I took out a patent for the improvement in 1852, at which time I constructed some screw engines that were thus fitted. Mr. Penn shortly afterwards applied similar counterweights to the engines of the Himalaya, and since that time these counterweights

have been very generally introduced. It was found in the Himalaya, that without the counterweights, the engines gave a most uneasy motion to the vessel, and also worked with great tremor and jolting; whereas when the counterweights had been applied, these injurious features of the rapid reciprocation of the engines were removed.

The principle on which the size of the counterweights should be adjusted to the wants of the engine, is of very easy apprehension. If the centre of gyration of the counterweights describes a circle of the same radius as that described by the crank pin, then the counterweights must just be as heavy as the piston, and all the parts which move with it. But if the centre of gyration of the counterweights has a greater radius than the crank pin, the counterweights must weigh less than the piston and its connections, and if it has a less radius, they must weigh more—the only material condition being that the momentum or amount of mechanical power resident in the counterweights when moving in one direction, shall balance the momentum of the piston and its connections when moving in the opposite direction, and which weight may be supposed to be collected in the crank pin.

MARINE GOVERNORS.

All marine engines, but especially screw engines, are liable to sudden fluctuations of velocity from the varying immersion of the propeller in a rough sea; and the necessity of employing some species of

governor to redress these irregularities, has long been perceived. The common form of engine governor that is used in land engines is obviously inapplicable to such a purpose, as the balls would open and close by the heaving of the ship; and various kinds of marine governors have been proposed to satisfy the want, of which the first, so far as I am aware, was invented by myself in 1834, and applied to the Don Juan steamer in 1836. This governor was formed with balls similar to those of a common governor; and it stood on a cross stay extending between the engines, which were of the side lever construction, and was driven by a bevel wheel on the intermediate shaft, which wheel gave motion to a bevel pinion placed on the top of the governor spindle, which stood in a vertical position beneath the intermediate shaft. Upon the spindle, near its lower end, was fixed a strong transverse bar; and on this bar the balls were strung, one ball being on each side of the vertical spindle. The balls were capable of being moved in or out on the transverse bar, but when the engine was at rest, they were retained in contact with the spindle by a great plate spring, one side of which embraced a collar or neck formed on each ball. When, however, the spindle was put into revolution, the centrifugal force of the balls overcame the tension of the spring to an extent corresponding to their velocity; and the outward motion of the balls acted upon the throttle valve by a connection similar to that usual in land engines, and which was moreover of such a nature, that the rolling or pitching of the ship, if it affected one ball, would also affect

the other in an equal and opposite manner, so as to afford mutual compensation and extinguish the effect of the ship altogether. There was in these engines a throttle valve in the injection pipe, as well as in the steam pipe, and the balls were made 14 inches in diameter, in order that they might have adequate power to overcome the friction of the parts, without requiring any great change of velocity to give the requisite centrifugal force.* Latterly, a marine governor called Silver's governor, and another called Porter's governor, both operating on the same principle as the foregoing, have been put forth. But the species of governor at present most employed in steam vessels, and which is known as Silver's fly-wheel governor, consists of a wheel like a small fly-wheel driven by a belt and with vanes like those of a fan fixed upon it, so that its revolution occasions a certain resistance. The driving pressure is transmitted through a spring, the tension of which measures the amount of the rotative resistance, and if the speed of the engine is constant, this tension is constant also. If, however, the speed of the engine is increased, the tension of the spring will be increased, and if the speed of the engine is diminished, the tension of the spring will be diminished; and these differences of tension are made to act on the throttle valve, and regulate the speed of the engine.

* I had models of several other kinds of governors constructed, in some of which there were four arms, and the balls compressed spiral springs. But only one example was practically introduced into a vessel by me, and as the vessel was lost shortly afterwards, this example was not much known.

In practice, Silver's fly-wheel governor is found to act in a perfectly satisfactory manner, and these governors have now been largely introduced.

BALANCED VALVES.

The three-ported valve, or that variety of it called the gridiron valve, is the kind of valve generally used in every species of engine: and in all marine engines of any considerable size, the pressure is taken off the face of the valve by some suitable equilibrium arrangement applied at the back. The arrangement most usually adopted consists in the application of a ring recessed in a groove at the back of the valve, which ring moves steam-tight upon the back of the valve casing; and within this ring a vacuum is maintained by opening a communication between the space encircled by the ring and the condenser. The practice of taking off the pressure by an arrangement of this kind originated with Messrs. Penn, who instead of a ring used at first a square frame. But this apparatus was difficult to construct; and it was consequently superseded by the ring, which was introduced by Mr. Edward Humphrys, to whom the steam engine is indebted for various improvements. In both Messrs. Penn's and Humphrys' arrangements, however, the ring is placed in a recess on the back of the valve, and moves with it. But in some engines drawn out under my direction in 1858 by Mr. Edward Cooper, the ring was recessed in the back of the valve casing, and the back of the moving valve worked steam-tight against this stationary ring.

This method of construction is now coming into general use; and it is preferable to the other method, as the ring, being stationary, is always accessible, so that it may be tightened up when the engine is going, whereas under Messrs. Penn's arrangement, the engine must be stopped, and the steam shut off, before the screws which tighten the ring can be approached at all. The ring which rubs upon the back of the valve may be of cast iron or brass; and above it is usually placed a ring of india rubber, and above that again a malleable iron ring, on which last ring the points of the tightening screws press. The whole of these rings are sunk in a recess cast in the door which covers the back of the valve casing; so that the cast iron or brass ring rises only a little way above the inner surface of the door. The back of the valve is planed true, and is sufficiently elongated for a portion of it to fall at all times within the ring, notwithstanding the travel of the valve. An example of the ordinary gridiron slide with ring at the back for taking off the pressure is shown in *fig. 5*, which is a representation of the section of one of the valves of the screw engines of the Great Eastern.

LINK MOTION.

This contrivance for giving motion to the valves is now employed in nearly every class of engines. It was brought out and applied to locomotives by Mr. Robert Stephenson in 1843, and was first applied to marine engines by Mr. Edward Humphrys. In a form of the link motion constructed by me in 1836, only

one eccentric was employed, which gave motion to a double-ended lever in which a slot was made nearly

Fig. 5.

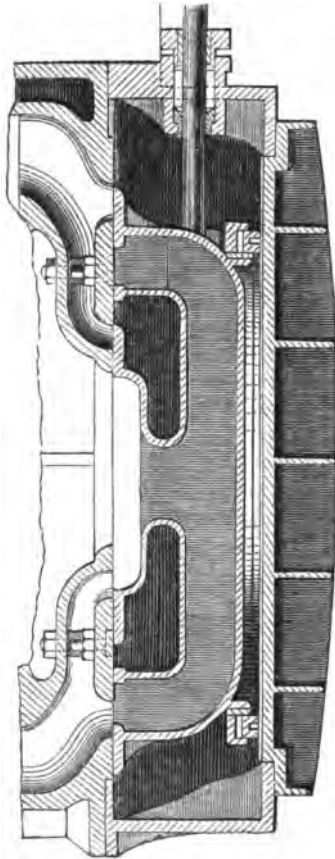

SECTION OF GRIDIRON SLIDE VALVE OF SCREW ENGINES OF THE STEAMER GREAT EASTERN,
BY BOUTON AND WATT.

from end to end. In this slot the pin was placed which communicated with the valve rod; and by moving this pin along in the slot, which was done by appropriate mechanism, the engine was stopped or reversed, and any desired amount of expansion was accomplished. The defect of this arrangement was, that it did not reverse the lead in reversing the engine. But in most cases an imperfect action of the valve when the engine is moving backward is not very material, seeing that it is only in rare cases that the engine is required to work backward for any considerable length of time; and the arrangement is simpler than the species of link motion now in common use.

STARTING CYLINDERS.

In the larger class of marine engines the links are now very generally moved by means of a separate cylinder and piston devoted to the special purpose of moving the starting gear. The starting cylinder employed in the steamers *Ulster* and *Munster* is shown in *fig. 6*. The links of both engines are raised or lowered simultaneously by rods connecting them with the cross head of the small starting engine, which is formed without a crank; and the piston rod is made hollow, with a screw working in it, which screw may be turned by the hand wheel shown at the top of the figure, if necessary, to assist the ascent or descent of the piston. Such assistance, however, is seldom required; but on the contrary, the piston in its ascent and descent puts the wheel into revolution, like the fly of a roasting-jack, first in one direction and then

Fig. 6.

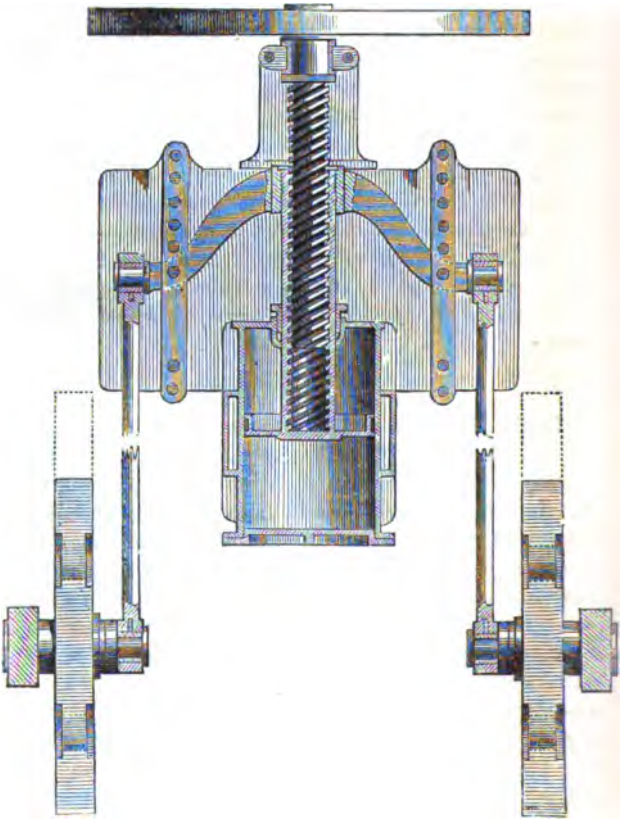

STARTING CYLINDER OF THE STEAMERS ULSTER AND MUNSTER, BY
BOULTON AND WATT.

in the other; and any jerk, striking, or injurious rapidity in the motion of the piston is thus prevented. The hand-wheel is furnished with internal handles, to enable the attendants to obtain a firm hold of it without entailing the danger of striking them in its rotation; and in practice the apparatus is found to work in the most satisfactory manner.

Starting cylinders of this or some analogous construction are now much employed in all classes of large engines. They were first introduced by myself in the steamer Don Juan in 1836; and a drawing of the engines of that vessel, in which the starting cylinders are shown, was published in the first number of the 'Artizan' in 1843. In 1852 I introduced starting valves, and they are now becoming general.

SHAFTS AND SHAFT BEARINGS.

The shafts of important engines, such as marine engines for driving the screw propeller, and also cranked and other axles of locomotives, are now frequently made of steel, which is peculiarly suitable for the formation of shafts, as its tensile and crushing strengths are both very much greater than those of any other known material. Piston rods are also sometimes made of steel. But the benefit of the practice is not so conspicuous in that instance; and in some cases steel piston rods have been found to break more frequently than iron ones. It is a good practice, however, to convert the iron piston rods into steel for a certain depth: as the benefit is thus

retained of the toughness of the iron rod, with the additional gain of the exemption from ruts, and the high polish, of the steel surface. In the case of large double cranks set at right angles—like those proper for a direct-acting screw engine—being formed of steel, it is a useful practice to join the two portions together by stout flanges placed in the middle of the length; as the magnitude of the piece is thereby reduced, and the inconvenience is obviated of having to produce so awkward a piece as that of a very large shaft with two double cranks at right angles formed upon it. In the casting of these shafts, the steel is melted in crucibles, and a succession of persons carrying these crucibles from the furnace to the point where the casting is made is kept up, so that the whole of the mass of metal is collected into the casting in a short time. After the casting has been made, it is dug out of the pit, while still red-hot, and carried to the forge hammer, where it is beat and finished as a forging. Even in the best steel works, however, the method of forming such large masses of steel is still very imperfect; and a complete reorganisation of the system is necessary, before steel can be so largely introduced for industrial purposes as it is destined to be at no distant time, and to which the imperfections of the manufacture now constitute the only visible impediment. The same remark may be extended to the production of articles of wrought iron; and in both cases improved methods are not difficult of perception which will completely change the rude and expensive systems at present employed.

The length of the bearings of shafts running at so high a velocity as the crank shafts of direct-acting

screw engines is now often made 3 or $3\frac{1}{2}$ times the diameter. Sometimes the bushes are lined with soft metal; and the shaft where it penetrates the vessel at the stern is usually covered with brass, and the pipe it passes through is lined with strips of wood, usually *lignum vite*. This method, which was introduced by Mr. Penn, is represented in *fig. 7*, where A is a brass bush or covering which surrounds the shaft B, and which revolves with it.

The cross section of the staves, or slips of wood surrounding A, with an intervening fillet of metal to steady the wood, is shown in the cut; and the lubrication is accomplished by the water which leaks through. For the eyes of feathering paddle wheels, wooden bushes are also sometimes employed; and generally each bush is formed by turning and boring out a solid piece of wood, but it is found that bushes put in in staves answer as well. Heretofore *lignum vite* was the wood generally used for these bushes. But it has now been found that African oak answers as well. The pins of the paddle wheels should always be covered with brass when wood is used: as the surface of iron becomes rough by corrosion, and then soon rasps the wood away. In sandy rivers wooden bushes do not last well, but are soon ground away;

Fig. 7.

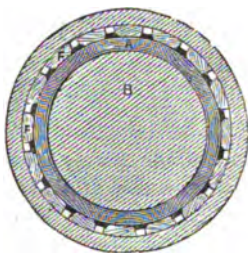

SCREW SHAFT BEARINGS; TRANSVERSE SECTION OF SHAFT AND PIPE AT STERN.

and in such cases steel bushes welded into the eyes and hardened, and fitted with hardened steel pins, are found to be the best arrangement. In sea-going steamers brass bushes and brass-covered pins are found to work very satisfactorily, and to wear well when the rubbing surface is made large.

ACTUAL AND NOMINAL HORSES' POWER.

The actual and nominal power of engines—at first identical or nearly so—soon began to diverge; and in time, as the pressure of the steam was increased, the actual power of an engine became twice greater than it had been at first, while the nominal power, being an expression of the dimensions of the engine, remained the same. The divergence, however, did not stop here, but has gone on increasing, until in recent engines the actual power exerted has been in some cases *nine times* greater than is represented by the nominal power. In other words, an engine of 200 horse-power nominal has been proportioned to exert as much as 1800 actual horses' power. The uncertainty and varying character of the ratio subsisting between the actual and nominal power is a source of much perplexity; and proposals have been made in consequence to substitute some other unit for the horse-power. But the proper course would be to retain the nominal power as a unit, but to define this unit to be a square yard or a square metre of heating surface of the boiler, instead of a given capacity of cylinder. As the boiler is the measure of the power actually exerted by an engine, this method of reckoning the nominal power would preserve a

more uniform ratio between the actual and nominal power than the present mode of reckoning.

The rule at present followed for determining the nominal power of an engine was first given by myself in my Treatise on the Steam Engine in 1844. The rule called the Admiralty rule is the rule of the late Mr. Barnes, who gave it to me in 1844, and was given by me to Mr. Lawrie, who made a slight change in it and subsequently communicated it to the Admiralty, by whom it was adopted. Mr. Barnes'

rule was $\frac{(d-1)^2v}{5640}$, where d was the diameter of the cylinder in inches, and v the velocity of the piston in feet per minute: and 1 inch was subtracted from the diameter of the cylinder, as a compensation for the friction. Mr. Lawrie discarded this allowance for the friction; and the rule then became $\frac{d^2v}{6000}$, which

is a simpler expression, but one which the Admiralty had no part in originating, as it was quite new to them when Mr. Lawrie communicated it. The rule given by me for the nominal power of land and paddle engines is $\frac{d^2\sqrt{s}}{47}$, where d is the diameter of

the cylinder in inches, and s the stroke in feet; and the same rule is applicable to direct-acting screw engines by taking a different divisor. A proper divisor in the case of those engines would be 23.5, which will make the nominal power of a direct-acting screw engine exactly double that of a land or paddle engine of the same size; and this rule, while sufficiently exact for practical purposes, will occasion the least amount of disturbance in the existing rules and

40 RECENT IMPROVEMENTS IN THE STEAM ENGINE.

tables for ascertaining the nominal power, as the power will just be the double of that which the existing low-speed rules and tables give.

In the average class of modern engines the actual power may be taken at 4 to 4½ times the nominal power. But in some cases it is the double of this, and rises to 8 or 9 times the nominal power. The pressure of steam and actual and nominal power of some of the modern vessels in the navy is shown in the following table:—

POWER AND PERFORMANCE OF NAVY STEAMERS.

Name of Vessel.	Tonnage.	Displacement in tons when triad.	Speed in knots.	Date of trial.	Pressure in boiler per sq. in. in lbs.	Nominal power.	Actual power.	Name of Constructor of Engines.
Adventure . . .	1793	2432	11.447	1862	12	400	1927	Ravenhill & Co.
Albion . . .	3111	2912	10.986	1862	24	400	1835	Humphrys & Co.
Arethusa . . .	3142	2801	12.695	1862	25	500	2871	Penn & Son.
Barossa . . .	1702	2301	11.514	1862	20	400	1616	Boulton & Watt.
Black Prince . . .	6039	9300	13.604	1861	25	1250	5772	Penn & Son.
Collingwood . . .	2611	2573	10.460	1862	20	400	1424	Rennie & Sons.
Conqueror . . .	1845	4300	9.934	1863	30	500	2018	Ravenhill & Co.
Constance . . .	3212	2781	12.301	1863	32½	500	2020	Randolph & Co.
Defence . . .	3720	5971	11.618	18.2	20	600	2537	Penn & Son.
Defiance . . .	3475	3958	11.884	1862	23½	800	3550	Maudslay & Sons.
Duncan . . .	3716	4000	13.236	1861	20	800	3428	Penn & Son.
Emerald . . .	2913	3508	12.003	1863	22	600	3223	Ravenhill & Co.
Euryalus . . .	2371	3125	10.038	1861	20	400	1262	Penn & Son.
Galatea . . .	3227	4270	13.004	1862	22½	800	3517	Penn & Son.
Gibraltar . . .	3716	5545	11.538	1862	22	800	3494	Maudslay & Sons.
Glasgow . . .	3037	2930	13.102	1862	20	600	2457	Ravenhill & Co.
Leander . . .	2760	2547	11.737	1861	20	400	1728	Boulton & Watt.
Liffey . . .	2654	3891	11.097	1862	20	600	1906	Penn & Son.
Liverpool . . .	2656	2914	12.665	1861	20	600	2551	Humphrys & Co.
Meane . . .	2591	3551	9.701	1862	20	400	1456	Penn & Son.
Octavia . . .	3161	2921	12.252	1861	20	500	2265	Maudslay & Sons.
Orontes . . .	2823	3400	12.622	1863	25	500	2249	Boulton & Watt.
Prince Consort . . .	4045	6430	13.119	1863	22	1000	4234	Maudslay & Sons.
Princess Royal . . .	3129	4270	9.934	1863	20	400	1499	Maudslay & Sons.
Resistance . . .	3716	4827	12.332	1862	20	600	2615	Penn & Son.
Revenge . . .	3318	5531	11.176	1862	30	800	2890	Maudslay & Sons.
Royal Oak . . .	4055	6416	12.529	1863	22	800	3704	Maudslay & Sons.
Shannon . . .	2651	3612	11.550	1862	20	600	2023	Penn & Son.
Sutlej . . .	3065	3826	11.087	1862	22	500	2270	Maudslay & Sons.
Undaunted . . .	3039	2694	12.925	1861	20	600	2503	Ravenhill & Co.
Warrior . . .	6039	8852	14.356	1861	22	1250	5469	Penn & Son.

MODERN FORMS OF BOILERS.

Boilers are divisible into three main classes, land boilers, marine boilers, and locomotive boilers, and of each class there are many varieties. The old waggon boiler is now almost extinct, and there is no generally accredited species of land boiler which has taken its place. On the whole, land boilers are approximating in construction to marine boilers.

In the earlier times of steam navigation the boilers employed were invariably flue boilers. It is very

Fig. 8.

Fig. 9.

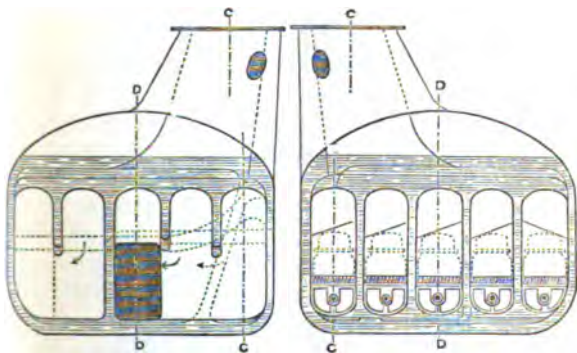

BOILERS OF STEAMERS ASIA AND AFRICA, BY R. NAPIER AND SON.

Transverse Section at A A, fig. 11.

Transverse Section at B B, fig. 11.

doubtful whether the efficacy of that class of boiler has yet been exceeded, and in some steam vessels of the highest efficiency flue boilers are still retained. Figs. 8 and 9 are transverse sections of the flue

boilers of the mail steamers Asia and Africa, and *figs.* 10 and 11 are longitudinal sections of the same

Fig. 10.

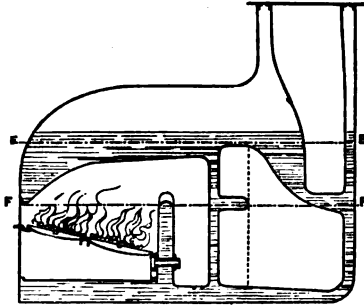

BOILERS OF STEAMERS ASIA AND AFRICA.
Longitudinal Section through C C, *fig.* 8.

Fig. 11.

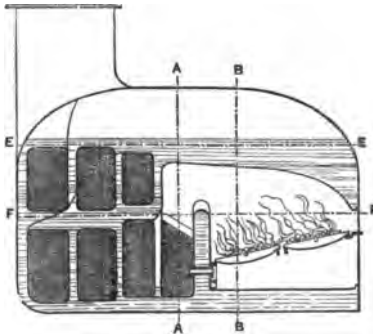

BOILERS OF STEAMERS ASIA AND AFRICA.
Longitudinal Section through D D, *fig.* 8.

boilers. Boilers of a similar construction to these have been in use in other vessels on the same line for the long period of 14 years.

The ordinary form of boiler now employed for marine purposes is the tubular boiler ; and the features of the arrangement have not varied much since the first introduction of the tubular system in 1844. An example of this species of boiler is given in *fig. 12*, which is a representation of an ordinary marine tubular boiler with Beardmore's superheater introduced in the uptake. The flame and smoke after passing over a brick bridge at the end of the furnace returns through the tubes to the front of the boiler ; and the smoke then passes up the chimney, but on its way thither encounters the horizontal tubes of the superheater. In this superheater there are two sets of tubes, separated by a diaphragm ; and the steam passes back through one set of tubes, and forward through the other, so that it traverses a distance equal to twice the length of the superheater.

The best forms of tubular boiler do not differ materially from that constructed by me in 1838 ; and with the increasing pressures which are now used, it is inevitable that the rectangular shell at present employed should be discarded. The boilers introduced by Messrs. Penn in the Hydra are represented in *figs. 13 and 14* ; and these boilers have the advantage of a cylindrical shell, and may be worked with safety to a pressure of 40 lbs. on the square inch. But the furnaces are too small ; and cylindrical furnaces are very inconvenient for enabling a proper slope to be given to the fire-bars, as the width of the

Fig. 12.

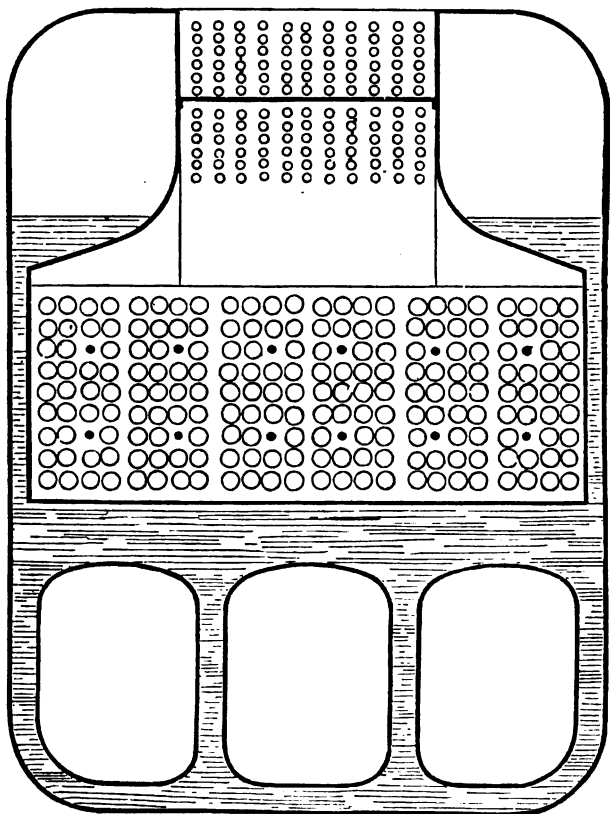

BEARDMORE'S SUPERHEATING APPARATUS.
Transverse Section.

bars at the back end is necessarily contracted ; and the bars must either be made taper, or taper pieces must be cast to fill the vacuities at the front.

Fig. 13.

Fig. 14.

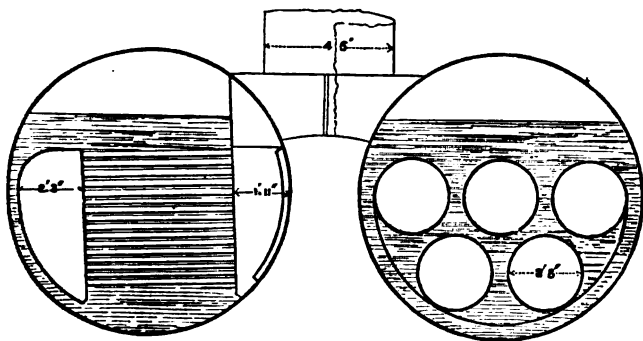

BOILERS OF H.M.S. HYDRA, BY MESSRS. JOHN PENN AND SON.
Transverse Section, showing Tubes. Transverse Section through Furnaces.

The species of water-space boiler known as Lamb and Summers' boiler has now been widely introduced, and has this special feature of advantage, that it enables a rapid circulation of the water to take place. This boiler is shown in *fig. 15*, which is a transverse section of the boilers of the steamer Ripon. In this boiler the smoke, instead of being returned through small cylindrical tubes, is returned through a row of very narrow flat-sided flues ; and in order to prevent these flat surfaces from being forced together by the pressure of the steam, they are strutted asunder by short struts, so that in the interior of the

boiler, the whole heating surface of these flues is clear of stays or other obstructions.

Fig. 15.

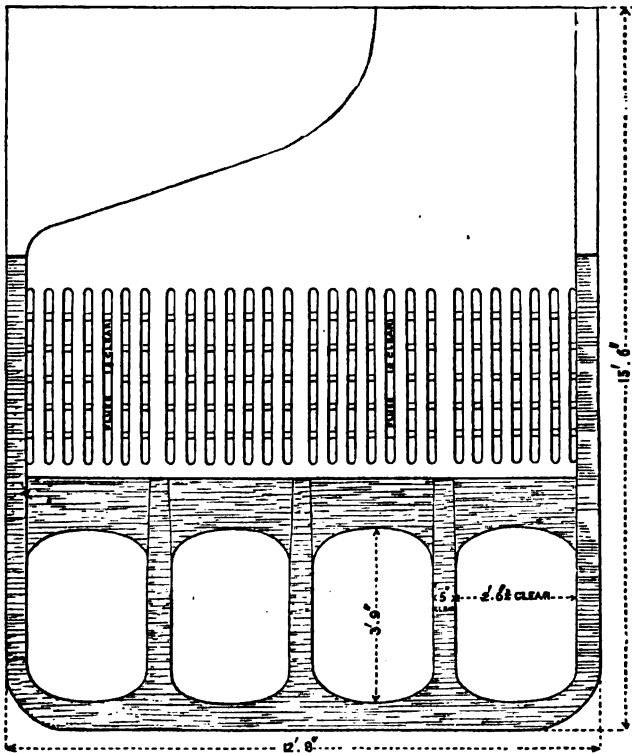

BOILERS OF STEAMER RIPON ON LAMB AND SUMMERS' PLAN.
Transverse Section.

The same benefit of an effectual circulation that is obtainable in Lamb and Summers' boiler is also obtained in the boiler with upright tubes invented by

Fig. 10.

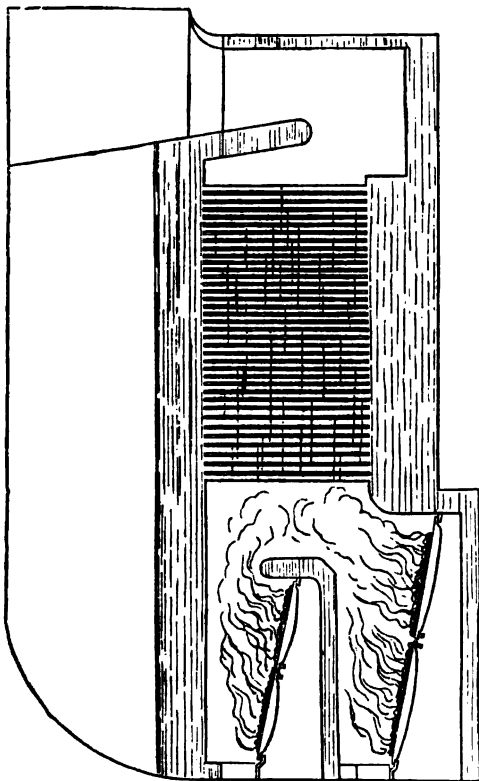

BOILERS OF COLLINS' LINE OF ATLANTIC STEAMERS, WITH DOUBLE-FURNACES AND UPRIGHT TUBES.
Longitudinal Section.

that remarkable genius the late Earl of Dundonald, and of which an example is given in *fig. 16*, which is a longitudinal section of one of the boilers of the steamer *Atlantic*. Boilers on this principle are not much used in this country, except in the case of the hay-stack boilers invented by Mr. David Napier, and which are very generally employed in the river steamers plying on the Clyde. In these boilers upright tubes, with the water within them, are also employed.

The importance of maintaining a rapid circulation in the water of the boiler is not yet sufficiently recognised. Not only will a rapid circulation add to the durability of the boiler by preventing the plates from being overheated, but it will materially increase the efficiency of the heating surface; and in the boilers of the *Atlantic*, it was found that by inserting a short piece of tube in the mouth of each upright pipe, whereby the length and consequently the velocity of the ascending column was increased, a sensible advantage was gained in the performance of the boiler. In many tubular boilers the tubes are set so closely together, that the circulation of the water amongst them is greatly impeded; and it has in consequence been found, that the evaporative power of such boilers has been increased by removing some of the tubes altogether—the loss of a part of the heating surface being more than compensated by the increased efficacy of the rest.

PROPORTIONS OF BOILERS.

The proportions of boilers per nominal horse-power are affected by two considerations—the first, what

ratio it is intended shall subsist between the actual and nominal power; and the second, what amount of surface shall be allowed for the evaporation of a cubic foot of water in the hour. The greater the excess of the actual over the nominal power, and the less the expansion, the larger manifestly must be the surface per nominal horse power; and in proportioning boilers of every class the main thing to be had regard to is the number of cubic feet of water required to be evaporated in the hour. But in different classes of boilers very different quantities of surface are required to evaporate a cubic foot per hour. Thus in Smeaton's boilers a cubic foot was evaporated per hour with 5 square feet of heating surface, in Watt's land boilers with 9 or 10 square feet, in locomotive boilers a common proportion is 5 or 6 square feet, and in Cornish boilers 70 square feet; and those boilers which have the most heating surface per cubic foot evaporated are the most economical in coal. Thus in Smeaton's boilers, a hundredweight of coal evaporated 14.11 cubic feet of water; in Watt's boilers about the same; in locomotive boilers from 11 to 12 cubic feet, and in Cornish boilers about 19 cubic feet. The election therefore has to be made between a large amount of heating surface per nominal horse power, and a somewhat increased consumption of coal. A given amount of heating surface however will be made more effectual, if a high temperature be maintained in the furnace, and if the circulation of the water within the boiler is rapid and unimpeded; and at all times the evaporative efficacy of the boiler will be much

increased by quickening the draught either by a blast pipe in the chimney or otherwise; but as somewhat more of the heat will in such case go up the chimney, there will be a somewhat increased consumption of coal.

The proportions of marine tubular boilers, as subsisting from 1844 to 1854, are exhibited in the following table:—

PROPORTIONS OF MARINE TUBULAR BOILERS.

By Boulton, Watt, & Co., 1844.

The actual power is here supposed to be $2\frac{1}{4}$ times the nominal, and the steam to be of 10 lbs. pressure per square inch, and to be cut off at two-thirds of the stroke.

Area and Contents.	Proportion per nominal Horse Power.	Proportion per actual Horse Power, 17½ lbs. on Piston.	Proportion per cubic foot of Water evaporated.
Heating surface of tubes in sq. ft.	10·25	4·10	7·25
Heating surface of plates in sq. ft.	2·75	1·10	1·75
Total heating surface in sq. ft.	13·00	5·20	9·00
Area of grate in sq. ft.	0·70	0·28	0·50
Sectional area of tubes in sq. in.	13·00	5·20	9·00
Sectional area of furnace uptake in sq. in.	16·00	6·50	12·00
Sectional area of chimney uptake in sq. in.	14·00	5·60	10·00
Sectional area of chimney in sq. in.	8·50	3·40	6·00
Area of base of boiler in sq. ft.	1·083	0·433	0·700
Capacity of boiler proper in cub. ft.	9·25	3·75	6·50
Capacity of steam-chest in cub. ft.	2·00	0·75	1·50
Total capacity of boiler and steam-chest in cub. ft.	11·25	4·50	8·00
Ratio of diameter to length of tubes	1·23 to 1·30		
Ratio of area to length of tubes	1·12 to 1·15		

In modern boilers, by the same makers, the proportion of grate of heating surface and of sectional area of tubes and chimney to evaporate a cubic foot of water per hour remain much the same; but as the proportion of actual to nominal power has been much increased, the dimensions of the boiler per nominal horse power have been much increased. Thus in

the steamer Scud, the engines of which were made by Boulton and Watt, the heating surface per nominal horse power is 28 feet, but that vessel works up to 8 or $8\frac{1}{2}$ times the nominal power. In more recent engines the same makers have given as much as 35 square feet of heating surface per nominal horse power. But these are exceptional cases: the usual proportion they give is 21 square feet per nominal horse power. Taking the evaporation as the measure of the power of the boiler, their present proportions for evaporating a cubic foot in the hour are as follows:—

PROPORTIONS OF BOILER TO EVAPORATE A CUBIC FOOT OF WATER IN THE HOUR. 1865.

Total heating surface of tubes and plates	. 10 square feet.
Grate surface 70 square inches.
Sectional area of tubes 10 "
Sectional area of back uptake 15 "
Sectional area of front uptake 12 "
Sectional area of chimney $6\frac{1}{2}$ to 7 "

The quantity of water required to be evaporated to produce an actual horse power, depends of course upon the rate of expansion. Boulton and Watt usually put sufficient lap upon the valves to cut the steam off at half stroke, and then by the aid of the link, they are able to cut off at $\frac{1}{3}$ of the stroke if required.

The particulars of the proportions and performance of the boilers of a number of modern steam vessels, as also the proportion of condensing surface per nominal horse power in the tubes of the condenser and other material facts, are recorded in the following table:—

PERFORMANCE OF VARIOUS SHIPS OF RECENT CONSTRUCTION BELONGING TO THE PENINSULAR AND ORIENTAL STEAM NAVIGATION COMPANY.

	Saitan.	Poonah.	Delhi.	Carnatic.	Baroda.	Meoolan.	Ripon.	Syria.
Tonnage, gross	1134 tons	2152 tons	1898 tons	1775 tons	1874 tons	2257 tons	1908 tons	1932 tons
Horse power, nominal	210	500	400	400	400	400	450	450
Diameter of cylinders	44½ in.	102 & 48	90 & 45	96 & 43	96 & 43	96 & 43	76	76
Length of stroke in feet	4-0	3-3	3-0	3-0	3-0	3-0	7-0	7-0
Consumption of coal per voyage	515 tons	825 tons	988 tons	687 tons	758 tons	817 tons	930 tons	1089 tons
Consumption per I. H. P.	299½ lbs.	2-39 lbs.	3-14½ lbs.	2-340 lbs.	2-593 lbs.	2-52 lbs.	2-69 lbs.	3-12½ lbs.
Indicated H. P. (mean at sea)	610	1335	1300	1250	1276	1200	1290	1200
Mean speed	9-5	10-35	11-09	11-4	11-7	9-92	10-0	10-0
Condensing surface per H. P., nominal	10-7	10-9	12-5	11-2	11-2	10-6	13-6	10-2
How expansion effected, whether by link or by separate valve	link	double cylinders	double cylinders	double cylinders	double cylinders	double cylinders	separate valves	separate valves
Whether any trouble experienced in lubricating pistons	none	the usual	none	the usual	the usual	none	none	none
Whether steam jackets or felting used	felting and wood	steam jackets	steam jackets	steam jackets	steam jackets	steam jackets	steam jackets	steam jackets
Whether much trouble is now experienced with valve faces	none	not much	none	none	not much	none	none	none
Heating surface per I. H. P., nominal	19-7 sq. ft.	12-5 sq. ft.	15-5 sq. ft.	12-0 sq. ft.	12-0 sq. ft.	12-0 sq. ft.	18-0 sq. ft.	18-0 sq. ft.
Grate surface per H. P., nominal	62	45	56	45	45	45	54	54
Area of flues per H. P., nominal	28 sq. in.	17 sq. in.	21 sq. in.	17 sq. in.	17 sq. in.	17 sq. in.	23 sq. in.	23 sq. in.
On "chimney"	17	11	13	11	11	11	15	15
On trial trip—								
Ratio of, indicated to nominal H. P.	1:4-1	1:4-5	1:5-7	1:6-1	1:6-2	1:4-3	1:4-4	1:5-7
Pressure of steam	18 lbs.	25 lbs.	25 lbs.	26½ lbs.	27½ lbs.	28 lbs.	24 lbs.	27½ lbs.
Temperature of ditto	290° in slide jackets	280° in slide jackets	300° in slide jackets	300° in slide jackets	360° in slide jackets	350° in slide jackets	300° in slide pipes	322° in steam pipes

SMOKE BURNING.

Notwithstanding the number of smoke-burning furnaces which have at different times been introduced, it cannot be said that any plan has yet been contrived which so far satisfies the conditions of the problem as to command general recognition of its eligibility, or to lead to its general adoption. These plans operate either on the principle of admitting air above the fuel to burn the smoke—which has the radical defect that the production of smoke in ordinary furnaces is variable, whereas the admission of air is constant, so that either too much or too little will generally enter—or on the principle of passing the smoke over the incandescent fuel, or through red-hot pipes or fire-brick passages—which though it will diminish the smoke, will rarely wholly prevent it; while the apparatus required is generally cumbrous. A proper smoke-burning furnace should obviate the smoke effectually; and it should be of simple construction, and be exempt from the objection of admitting too much or too little air to burn the smoke. In steam vessels it is most desirable that some proper species of firing apparatus should be employed; as the labour and difficulty of firing large furnaces at sea, especially in hot climates, is very great.

In 1838 I took out a patent for a smokeless furnace; and I then originated the doctrine—since so generally accepted—that instead of seeking to *burn* smoke, the proper course was to *hinder its formation*. In 1839 I introduced smokeless furnaces into different

steamers, in which the arrangements had to vary to suit existing boilers; and in some cases I caused the smoke to pass over the incandescent fuel, in other cases to pass through heated fire-tile channels, and in other cases again two adjacent furnaces were fired alternately, and the smoke from the one passed through the glowing embers of the other. All these expedients, however, are imperfect; and no species of smokeless furnace has yet been contrived of such conspicuous eligibility, as to ensure its general adoption. I believe that a good smokeless furnace and a good self-feeding furnace will come together; and I also believe that the realisation of this desideratum is not very far off.

ON THE RESISTANCE OF SHIPS.

The doctrine first promulgated in my Catechism of the Steam Engine, that in well-formed steam vessels of the common type nearly the whole of the resistance is occasioned by the friction of the water upon the bottom of the vessel, instead of being mainly produced by the act of separating the water at the bow and closing it at the stern, as was the previous doctrine—is now receiving general recognition; and computations based on that supposition are found to accord very closely with the results obtained by experience. I was led to this conclusion from having to design some steamers in 1853, which I was desirous should possess the maximum speed with the minimum power, and I therefore constructed them on the pendulum lines recommended in the Catechism of

the Steam Engine, as the most eligible for this purpose. I found the vessels when constructed and tried perfectly to fulfil my expectation of passing through the water with the minimum of disturbance, and there was no wave produced at the bow, or at any other part. Nevertheless, I did not find the speed to be sensibly superior to that of other vessels of ordinary good shape, and of similar size and power; and as in my vessels nearly the whole resistance was certainly that of friction, and as the total resistance was nearly the same as that of common vessels, there was no escape from the conclusion, that in ordinary sharp vessels nearly the whole resistance is also that of friction. This discovery points to the supreme importance of endeavouring to reduce the friction of the bottom; and it is found by recent experiments made in France, that the friction will be a good deal influenced by the nature of the coating* which the bottom receives. There is a great need for improvement here; whereas very little improvement is to be expected from altering the shape of the steamers we at present employ. We must of course draw them out to greater length, as we require higher speeds, and introduce more power; and contract them to shorter lengths as we are satisfied with the lower speeds proper to less power. But this elongation or contraction is merely a question of putting up the frames nearer together or further apart, and does not affect the shape, but only the proportion of length to breadth. The proper shape for a ship may be

* This topic is treated of more fully in my 'Hand-Book of the Steam Engine.'

expressed by an equation, only there will be a certain proportion of length to breadth, which will be suitable for each particular speed, or, in other words, the proper length will be a function of the intended speed; so that if we wish to double the speed, we ought also to double the length.

The friction of ships has been sought to be measured by the friction of water running in pipes and canals. But the friction per square foot of a ship is much less than the friction of a square foot of pipe or canal when the water and the ship are moving at equal velocities. The velocity of water in a pipe is usually measured by the discharge. But the discharge measures only the *mean* velocity, whereas it is the *maximum* velocity which is alone comparable with that of a ship. Moreover there is every reason to believe, that the friction of a ship per square foot is not the same at all parts, but will be more at the bow and less at the stern. The friction of the bottom and sides puts in motion a film of water of increasing thickness, and also of increasing velocity, which moves with the ship; and as the stern part is immersed in this moving water, the friction upon it is not so great as it would otherwise be. Screw propellers placed at the stern utilise a portion of this moving column by working in it; for the operation of this column is to diminish the visible slip, which is consequently less than would be the case if the screw were placed at the bow; and in some cases, indeed, there is not only no visible slip in the screw, but the visible slip is negative, or, in other words, the vessel travels faster than the screw.

DOUBLE SCREWS.

A screw placed in each quarter is now often employed instead of a screw situated at the stern; and in my Treatise on the Screw Propeller, published in 1852, I strongly recommended that method of construction. Two screws have these advantages over one: they enable the necessary propelling area to be obtained at a greater depth in the water; and I long since explained—what Mr. Rennie's experiments have since demonstrated—that the resistance which the water would offer to the screw would depend mainly on the depth of its immersion, since the displacement will always be in the line of least resistance which is to the surface, and the resistance or grip will vary as the depth. Then two screws enable the ship to be easily manœuvred, if they are driven by separate engines; and finally the vessel is not wholly disabled, but will still have sufficient propelling efficacy to proceed on her voyage, even if one screw or screw-shaft should happen to break. These considerations render it probable, that two screws will obtain a preference over one; and each screw may be driven by a single horizontal balanced engine of the kind introduced by me in 1852, and which has been ever since at work in various vessels constructed by me about that time. This species of engine is described in the Catechism of the Steam Engine, p. 433.

VARIOUS FORMS OF SCREW.

Notwithstanding the vast number of different kinds of screws which have been tried and proposed since

the first introduction of screw vessels, there does not appear to be any better screw yet contrived than Smith's original screw with uniform pitch, as fitted in the Rattler. For merchant vessels three blades are preferable to two. But in the case of war vessels made with lifting screws, more than two blades cannot be employed. Lifting screws, however, appear likely to go out of use altogether. The gear they involve is a source of expense and complication, and is liable to shake loose in time and give trouble; while the benefit of the arrangement is very small. Steam vessels will almost always use steam; and for those rare occasions when it is wished to impel them by sails without steam, the resistance presented by the screw will not be great, if it be suffered to revolve like a great patent log, the function of which it may also be made to fulfil in measuring the speed of the vessel.

LAND ENGINES.

Single and Double Cylinder Engines compared.

One of the most interesting illustrations of the comparative merits of the single and double cylinder engine, is afforded by the simultaneous erection of certain engines of each class and of the same power at the New River Waterworks in London. Both classes of engines are rotative engines, and they employ the same pressure of steam. The single cylinder engines which were constructed by Messrs. Boulton & Watt, have cylinders 60 inches diameter and 8 feet stroke. The double cylinder engines which

were constructed by Messrs. Simpson & Co., have low-pressure cylinders of 46 inches diameter and 8 feet stroke, and high-pressure cylinders of 28 inches diameter and 5 feet $6\frac{3}{4}$ ths stroke. The pumps are the same in each case, being the combined piston and plunger pump invented by Mr. David Thomson, and first introduced by Messrs. Simpson in the Richmond Waterworks in 1848. The pressure of the steam in the boiler is 38 lbs. per square inch, and about 8 lbs. less than this in the cylinder at the commencement of the stroke. The pump lifts the water 127 feet, and the friction is about 33 feet. The performance of these two classes of engines is as nearly as possible the same, being about 87 millions of pounds raised one foot high by the consumption of a bushel or 94 lbs. of Welsh coals. This is equivalent to 1.9 or rather less than 2 lbs. per actual horse-power per hour.

Balanced Double Cylinder Engine. An example of this species of engine as made by Messrs. Carrett, Marshall & Co. of Leeds is exhibited in *fig. 17*. In this engine the cylinders are horizontal and the cranks are nearly opposite to one another, so that the pistons move in opposite directions, thereby balancing their own momentum while a very direct passage is at the same time afforded for the steam escaping from the high-pressure cylinder to enter the low-pressure one. The air pump is double acting, and for very high speeds is set vertically at the end of the engine, and is wrought by levers so proportioned, that the stroke of the air pump is half that of the piston. Messrs. Carrett & Co. consider that this engine

Fig. 17.

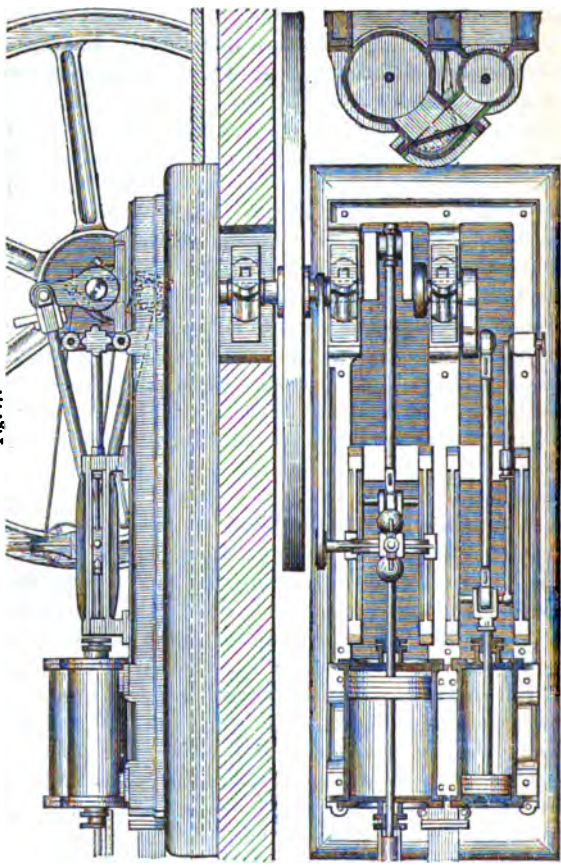

CARBETT, MARSHALL AND CO.'S BALANCED DOUBLE CYLINDER ENGINE.
Elevation Ground Plan and Transverse Section.

may be worked up to 600 feet per minute,* which may probably be done without inconvenience if the parts and passages are made sufficiently large, and if the bearings, piston-slides, and all the rubbing parts are made of sufficient area, and are well lubricated. In very fast moving engines it would be proper to have a small oil pump which would send an excess of oil to all the bearings, and this excess should on overflowing be returned into a small cistern or recess in the bed plate into which the oil pump would dip. A very effectual lubrication would thus be attained with certainty, without trouble, and without waste of oil; and the oil would not merely lubricate, but would *cool* the bearings, the heating of which at all speeds would thus be prevented.

Engine and Boiler combined. A form of engine and boiler convenient for many purposes is shown in *fig. 18*, which is an elevation of a 20-horse engine set on the top of a tubular boiler constructed by Messrs. Carrett, Marshall & Co. of Leeds. This species of engine and boiler is easily removable, and may be set down anywhere without the necessity of foundations or any species of bricklayer's work. If it is thought desirable at any time to double the power, this may be done by setting another engine and boiler alongside the first, and connecting the two by a shaft; and one flywheel will suffice for both engines.

Another form of engine and boiler constructed by

* In 1854 I constructed a balanced marine with cylinder 42 inches diameter and 42 inches stroke, the piston of which worked at a speed of 700 feet per minute.

these makers is exhibited in *fig. 19*. Here it will be seen that both the engine and boiler are vertical, and as the engine is placed on top of the boiler, no foundations are required. The heating surface of this boiler is all formed of boiler plate, and consists of an internal fire box, water box, and uptake flue.

Fig. 18.

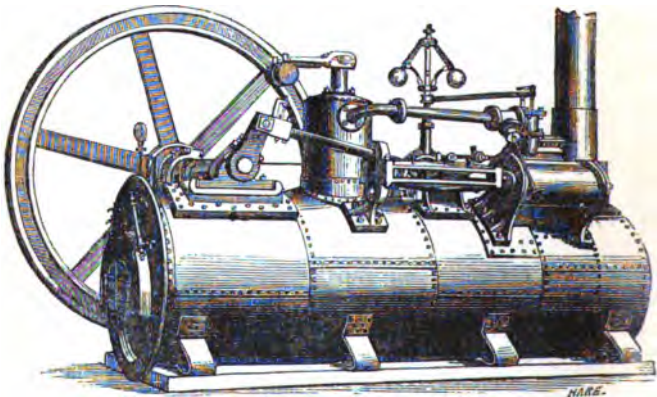

CARRETT, MARSHALL AND Co.'s COMBINED ENGINE AND BOILER.

Another example of an engine set on a boiler and constructed by the same makers is shown in *fig. 20*, which is a form of engine applicable for pumping deep wells or mines. The boiler is set across the mouth of the well or shaft, and the pump is wrought off a pin in a plate or chuck fitted with internal gearing, to the end that the engine may move fast while the pump

Fig. 19.

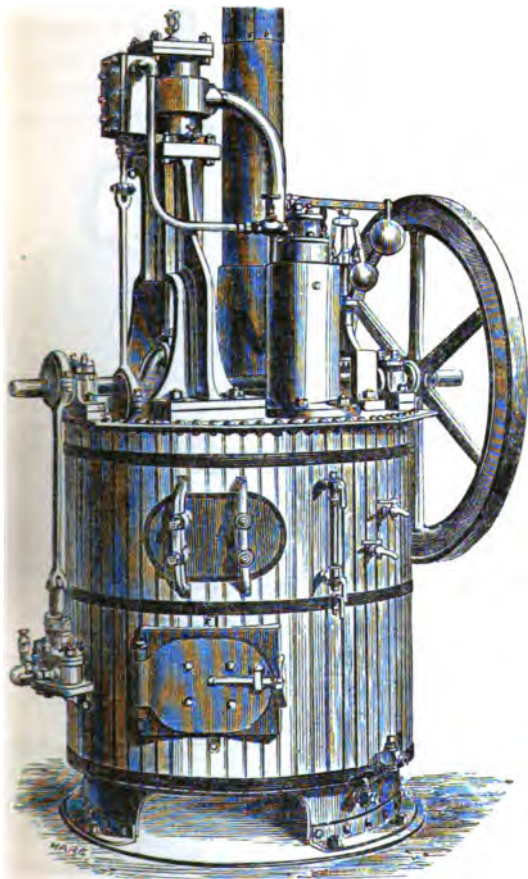

VERTICAL ENGINE AND BOILER BY CARRETT, MARSHALL AND CO., LEADS

64 RECENT IMPROVEMENTS IN THE STEAM ENGINE.

Fig. 20.

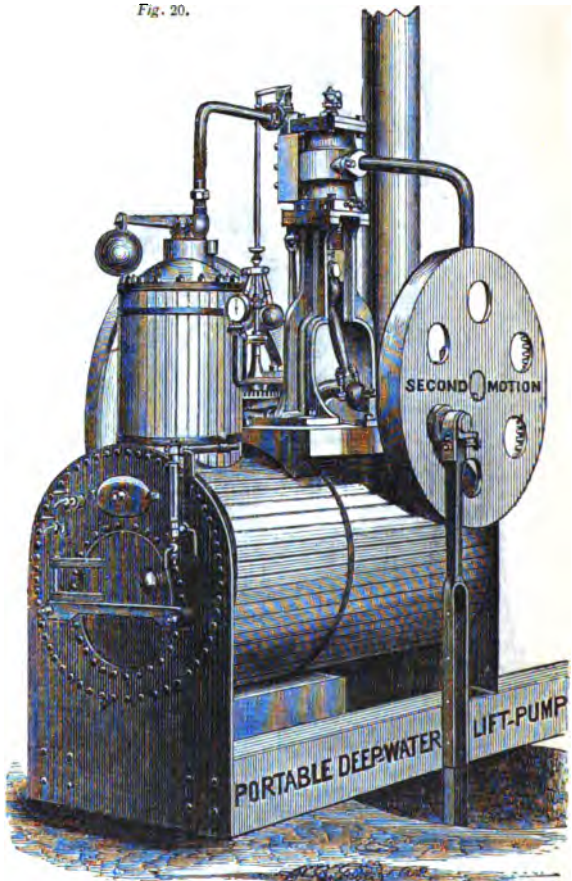

CARBETT, MARSHALL AND CO.'S PUMPING ENGINE AND BOILER.

moves slowly. This engine may also be used for irrigation.

Inverted Pumping Engine. An inverted pumping engine similar to the foregoing is shown in *fig. 21*; but here the boiler is removed, and the engine is set

Fig. 21.

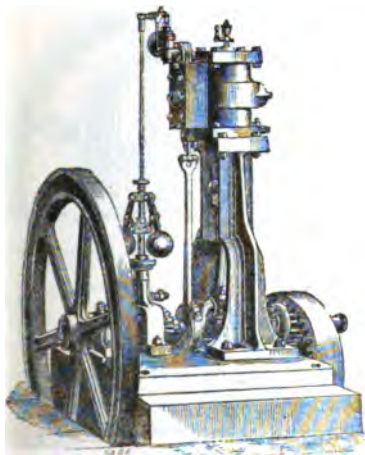

CARRETT, MARSHALL AND Co.'S FIXED PUMPING ENGINE
FOR DEEP LIFTS.

on an appropriate foundation. The gearing whereby the fast engine drives the pump slowly is shown at the right in this drawing.

Inverted Factory Engines. *Figs. 22* and *23* are representations of the inverted engine of the same makers suitable for general purposes. *fig. 22* being a

Fig. 22.

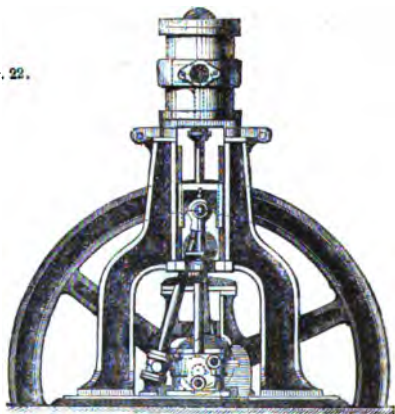

CARRETT, MARSHALL AND Co.'s VERTICAL ENGINE. Front Elevation.

Fig. 23.

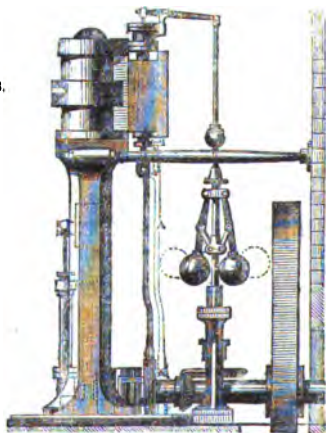

CARRETT, MARSHALL AND Co.'s VERTICAL ENGINE. Side Elevation.

front elevation, and *fig. 23* a side elevation. In these engines the stuffing box in the bottom of the cylinder, through which the piston passes, is projected inwards above the cylinder bottom, so that there can be no dripping of water from the stuffing box, and if there is any leak it will be a leak of steam. The piston is suitably recessed to receive the projecting stuffing box.

Engine for working Hydraulic Pumps. A variety of this species of engine as applied to work hydraulic pumps for pressing bales, or for working any other kind of hydraulic apparatus, is shown in *fig. 24*. There is a large and a small pump employed, and the large pump having created as much pressure as it can, feeds the small one. The arrangement is so contrived, that when the maximum pressure has been attained by the small pump, it stops the engine—thus obviating a waste of power by forcing the water through a loaded valve.

Ordinary direct acting Vertical Engine. In the vertical engine of Mr. Ferrabee of Stroud, the crank shaft lies across the top of an appropriate framing, with the cylinder beneath. This engine is represented in *fig. 25*, which is sufficiently illustrative to enable the material features of the engine to be readily apprehended. The engine is fitted with an expansion valve of the piston construction, and the amount of expansion is regulated by the governor which moves in or out, in an appropriate link motion, the point which moves the expansion valve; and the amount of its throw is correspondingly affected, and consequently the rate of the expansion. The feed water is heated

by the waste steam, and the general design of the engine is very judicious.

Fig. 24.

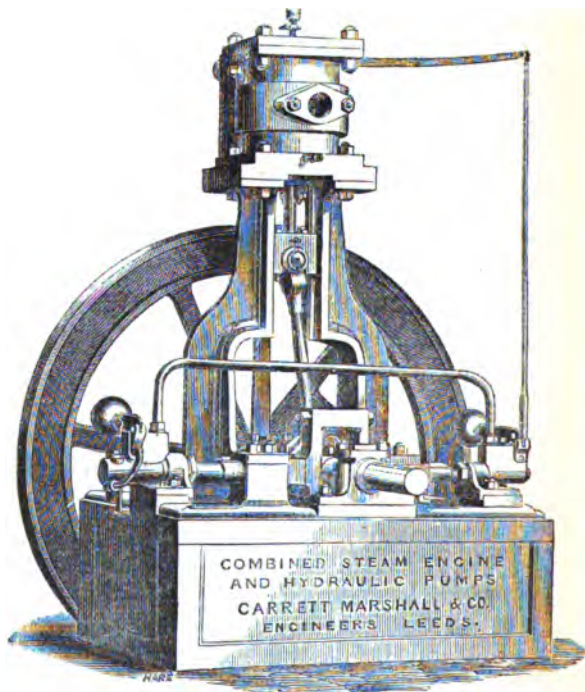

**CARRETT, MARSHALL AND Co.'s COMBINED STEAM ENGINE AND
HYDRAULIC PUMPS.**

Fixed Horizontal Engine. The horizontal engine

Fig. 2A.

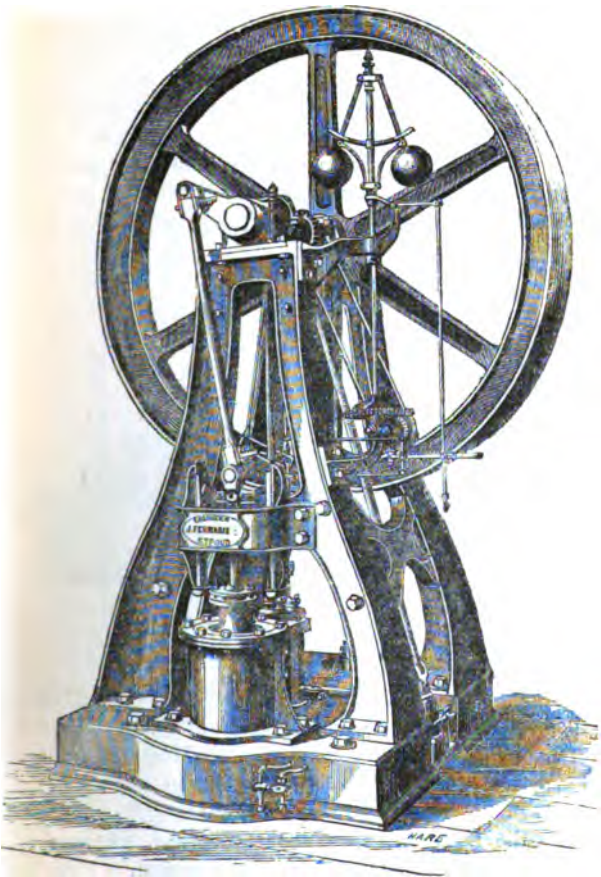

VERTICAL ENGINE BY FERRABEE OF STROUD.

of Messrs. Carrett, Marshall and Co. is shown in *fig. 26*, and this may be accepted as the common type of horizontal engine employed by most makers at the present time. The main features are a good strong bed-plate, to which the cylinder may be not merely bolted but also keyed against lugs, to obviate end play; and it is preferable to cast the shaft pillow-block upon the bed-plate rather than to bolt it on, for the sake of obtaining greater exemption from thrust or play.

Fig. 26.

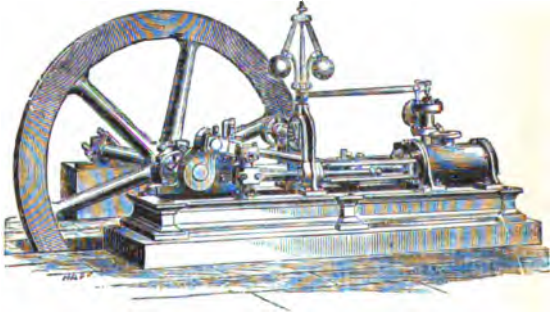

CARRETT, MARSHALL AND CO.'S HORIZONTAL ENGINE.

Donkey Engines. *Figs. 27* and *28* represent Hawthorne's donkey engine for feeding boilers, and *figs. 29* and *30* represent similar engines by Messrs. Carrett, Marshall & Co. They may be taken as common types of the Donkey engine; but Messrs. Hawthorne turn the fly-wheel by a connecting rod, whereas a frame with horizontal slot is more common.

Figs. 27 and 28.

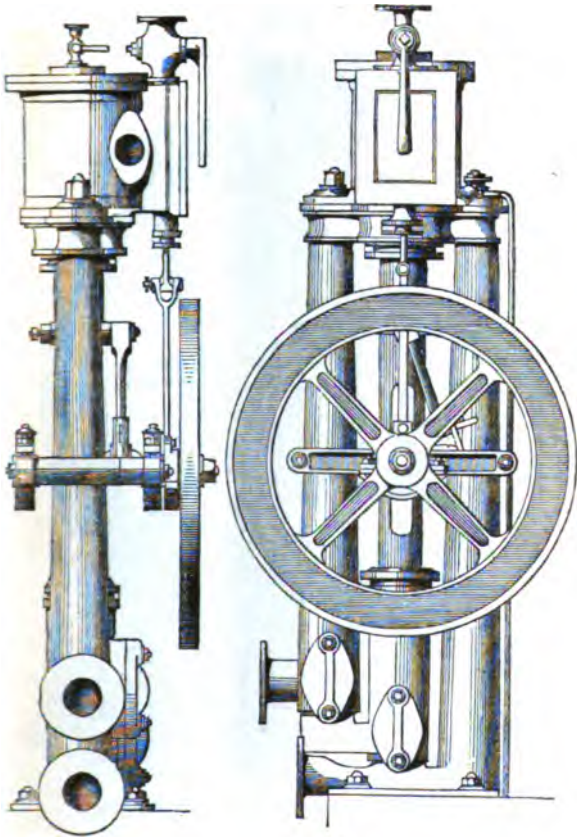

HAWTHORNE'S DONKEY ENGINE.
Front and Side Views.

Fig. 29.

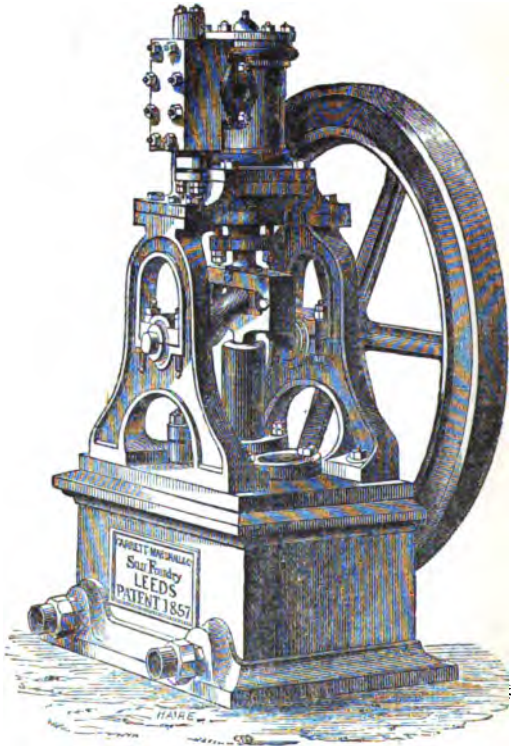

CARRETT, MARSHALL AND Co.'s STEAM PUMP.

Fig. 30.

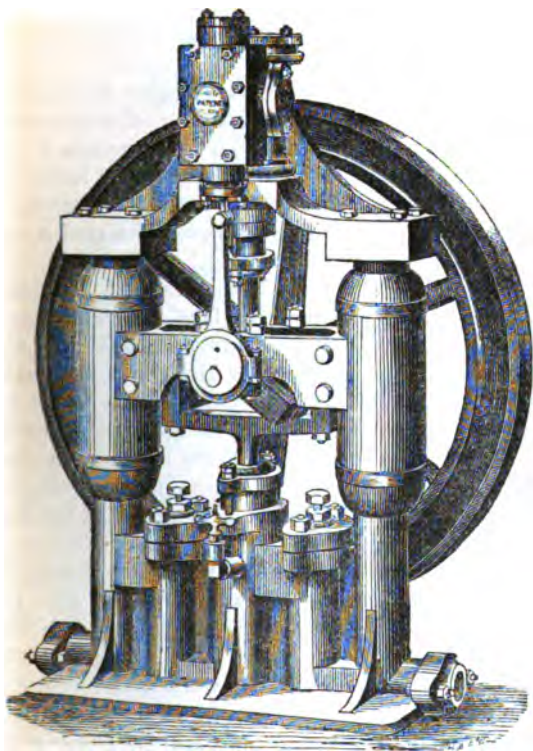

CASETT, MARSHALL AND CO.'S DONKEY FEED ENGINE.

Fig. 31 represents a form of engine suitable for lifting water through moderate heights, and useful for feeding boilers, filling tanks, pumping water for irrigating, forcing liquid manure, and other similar purposes.

A useful form of water pressure engine which may be employed for blowing organs and for other domestic purposes is shown in *fig. 32*. These engines were first applied to such purposes by Mr. David Elder of Glasgow, who constructed a water pressure engine to blow the organ in Mr. Napier's house at Shandon on the Clyde.

Engines for high speed. Messrs. Carrett, Marshall & Co. employ engines to drive fans and centrifugal pumps direct without intermediate belting. An example of this combination is given in *fig. 33*, and it will be seen that the momentum of the piston is balanced by counterweights on the fly wheels, in the interior of the rims of which there are grooves into which fit corresponding projections on pulleys on the fan spindle, by the friction of which contact the fan is driven.

The best form of centrifugal pump is that of Appold with curved vanes, as represented in *fig. 34*. In 1851 pumps by Appold with straight vanes, with inclined vanes, and with curved vanes, were carefully tested, and it was found that the work done relatively to the power expended amounted with the pump with straight vanes to 24 per cent., with the pump with inclined vanes to 43 per cent., and with the pump with curved vanes—such as are shown in *fig. 34*, to 68 per cent. This pump has been much used in

Fig. 31.

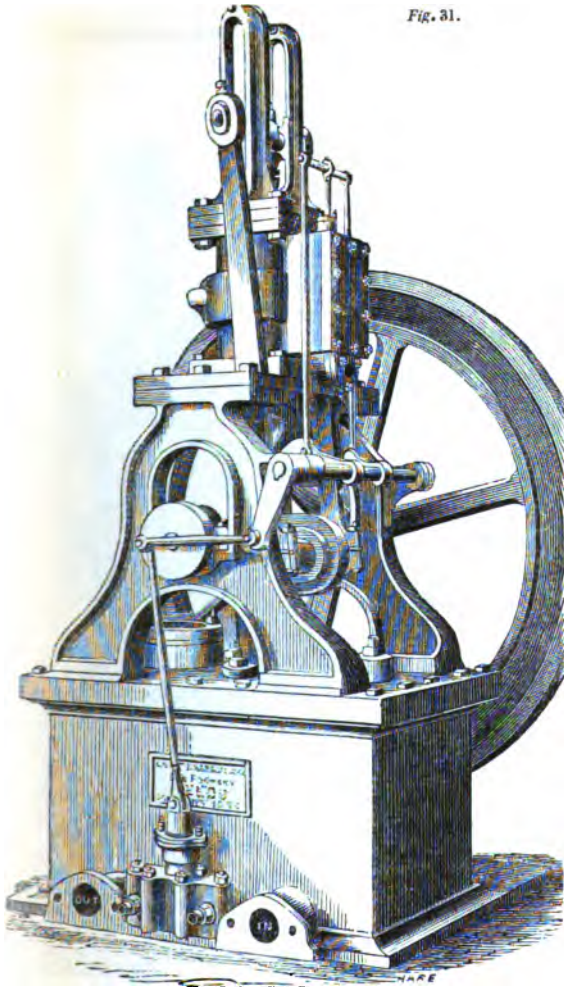

CARRETT, MARSHALL AND CO.'S WATER LIFTING ENGINE.

Fig. 32.

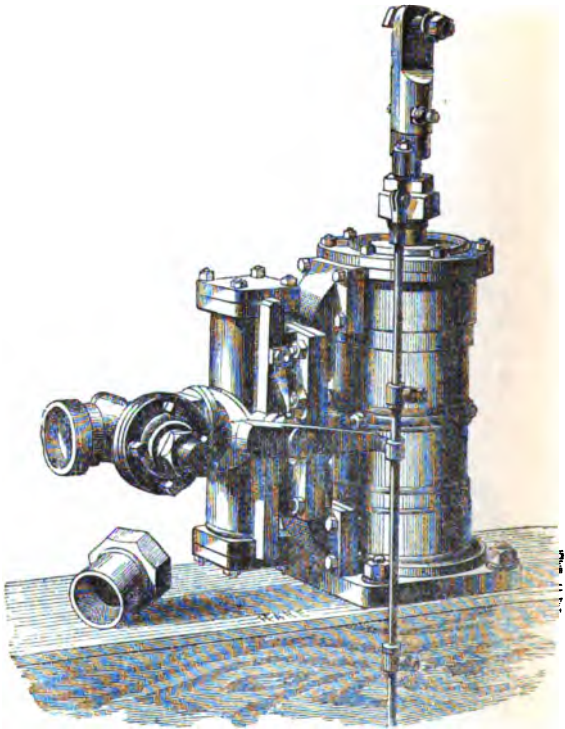

CARRETT, MARSHALL AND Co.'s WATER PRESSURE ENGINE.

Fig. 33.

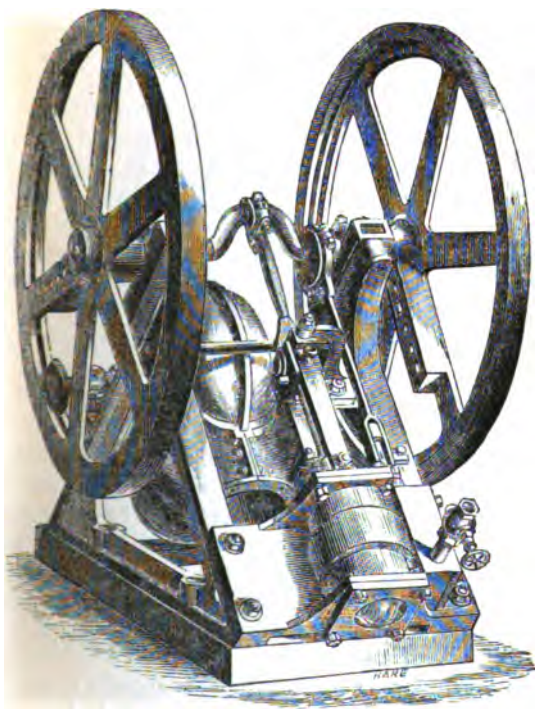

BALANCED VELOCIPED ENGINE BY CARRETT, MARSHALL AND CO.

raising water for irrigation, for draining land and foundations, for pumping out docks, and for various other purposes for which low lifts are required. But

Fig. 34.

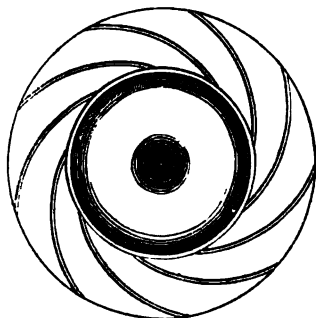

APPOLD'S CENTRIFUGAL PUMP, BY EASTON, AMOS AND SON.

for some of these purposes the chain pump formed with square boards moving slowly in a wooden trunk appears to be fully as effective. The centrifugal pump is sometimes driven by toothed wheels, and sometimes by serrated surfaces of contact such as is shown in *fig. 33*, and which is known by the name of frictional gearing. But toothed wheels require to work so very fast when the lift is at all considerable, that they are soon cut away, and it appears advisable when gearing is used in such cases to make it spiral, or in steps, and with the teeth bottoming and very broad. If frictional gearing is used, it should be of much greater breadth and power than the authors of that scheme deem necessary, seeing that in certain

cases the wheels which have been deemed by them of adequate size have been quite insufficient to transmit the strain.

Messrs. Easton, Amos & Son combine the pump and the engine to drive it into one structure, and have found from a carefully conducted experiment with one of these machines, that with a mean lift of 6 ft. 6 in. nearly, the fan making 124 revolutions per minute, a quantity of water. = 6748 cubic feet or nearly $183\frac{3}{4}$ tons per minute was delivered. The engine power as per indicator diagrams, carefully taken, being 111.2 horse power, it follows that the useful work done was in this case $73\frac{3}{4}$ per cent. nearly of the power expended.

From several carefully conducted experiments made by the Court of Policy of Demerara upon one of the pumps in that country, it was found that the useful work done = 66.55 per cent. of the power expended, while a well-constructed scoop, tried under precisely similar circumstances, gave no more than 22.3 per cent., and a centrifugal pump of another construction, 29.3 per cent. only.

By the combined system of construction any settlement of foundations which is more or less inevitable in all Fen districts is neutralised, as the whole of the machinery is self-contained, and its working unaffected by settlement, while the first cost of building foundations and masonry is materially less than by any other plan.

The arrangement of engines employed to drive Appold's centrifugal pump, by Messrs. Easton, Amos & Son of London — by whom large numbers of

Fig. 35.

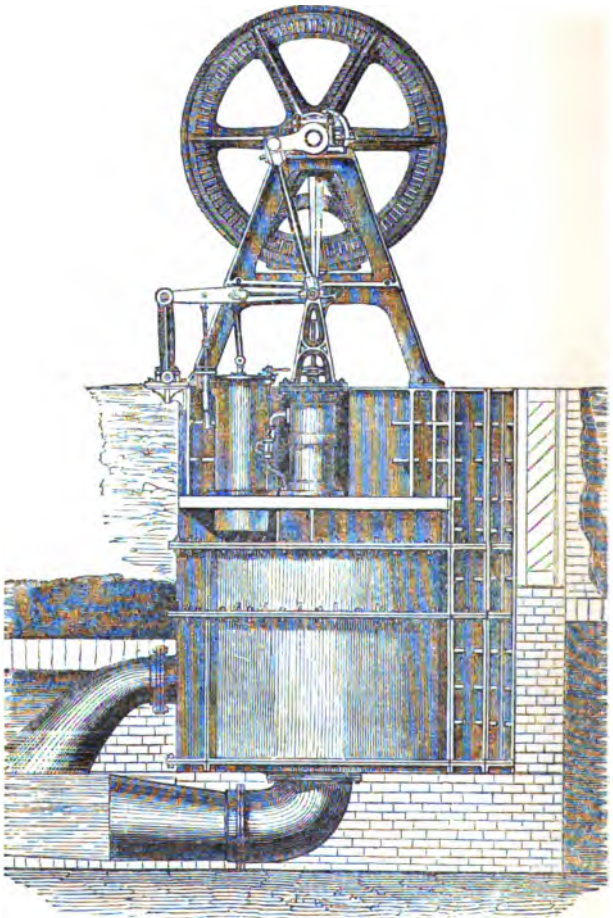

CENTRIFUGAL PUMP, BY EASTON, AMOS AND SON.

these pumps are made—is shown in *fig* 35. The spindle of the fan is vertical, and is armed at the top with a bevel pinion, to which motion is given by a bevel wheel placed on the shaft of the engine. The fan is contained in a cast iron casing which also serves to support the engine, and there are two suction pipes, one for each side of the fan. The water drawn in at the centre of the fan is put into rapid rotation by the curved blades, and escapes at the periphery with such velocity as to support a corresponding column of water, and if the head is less than that—as it always is—the water necessarily overflows at the higher level. Centrifugal pumps have this great advantage, that they are without valves, and are consequently as efficient in forcing dirty water as in forcing clean—a quality which in many cases is of great value. They have sometimes been employed for maintaining the circulation in surface condensers. But the plan of using one of the air pumps as a circulating pump is simpler and is to be preferred.

Common Lever Engine. The old form of beam engine is still used for many purposes. An approved form of engine and sugar mill for expressing the juice from canes is shown in *fig*. 36. There is no novelty about this engine except the great strength of the different parts, which in this class of machinery is quite indispensable to obviate continual breaking down. The sugar mill consists of three rollers, and the canes pass down the inclined feeding table, and pass under the upper roller which squeezes out the juice.

Cowper's combined Engines. In cases where great uniformity of rotative power is important, combined

with a large measure of expansion and a high pressure of steam a form of engine such as is represented in *fig. 37* may be employed. This engine is a double cylinder engine; but instead of the pistons being made to operate on the same crank, as in ordinary double cylinder engines, or on opposite cranks, as in Messrs. Carrett, Marshall & Co.'s arrangement, the cranks are set at right angles with one another, so that when one piston is at its dead point the other is exerting its greatest power.* The small cylinder, instead of discharging directly into the large one, discharges into a reservoir beneath the engine, from which reservoir the large cylinder is fed; and the equability of motion proper to two engines working at right angles is thus obtained, with a large measure of expansion. This form of double cylinder engine appears to be an eligible form in cases in which two engines are necessary, as the benefits of large expansion are obtained without greater complication than that which appertains to two separate engines of the common kind.

The engines shown here were constructed by Messrs. Walter May & Co. of Birmingham, and set to work in the International Exhibition of 1862. The engines were made from the design of Mr. E. A. Cowper, by whom the plan was invented and patented. These engines were the only pair that was at work as condensing engines in the Exhibition, owing to there being no *large supply* of cold water

* This arrangement of the cranks and pistons was patented by Craddock in 1844, and was described in the 'Artizan' at that time.

Fig. 37.

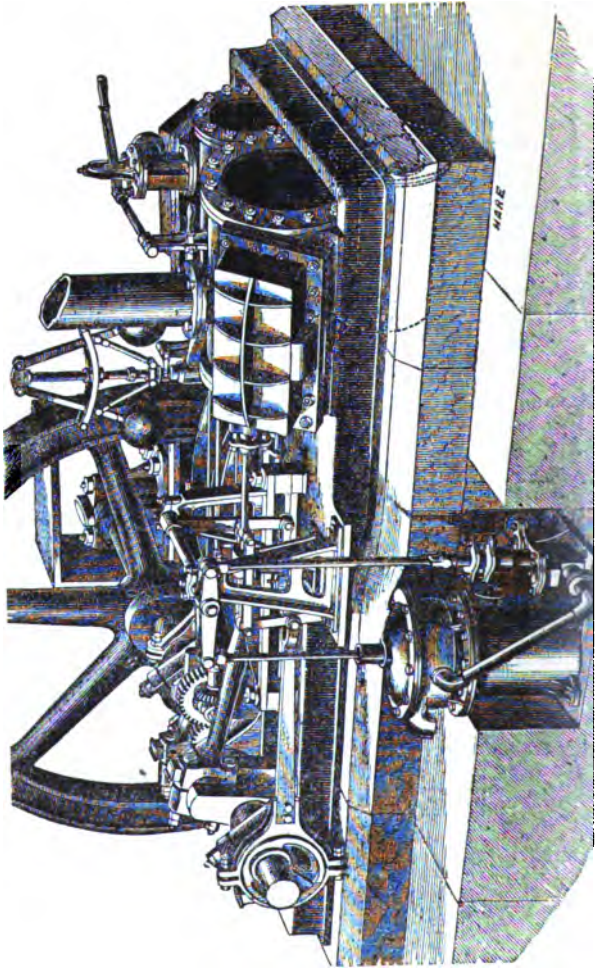

available for condensing. The resource by which they were enabled so to work was by the application of Perkins' Surface Evaporator Condenser, which was adopted by Messrs. Walter May & Co. in this instance as a means of easily obtaining an excellent vacuum with a very small supply of water, viz. a supply equal only to the quantity of water used in the form of steam. Mr. Cowper's engine is fitted with a steam jacket, and the steam is expanded into nine times its original volume. But of course by earlier cutting off, this measure of expansion may be increased as much as may be desired.*

Continuous Expansion Engine. In Nicholson's continuous expansion engine the benefits of large expansion without increased complication, or the necessity of a receiver, are obtained by admitting the steam from the boiler into only one cylinder of a pair of engines; and when half the stroke has been performed, and the piston of the other engine is just beginning its stroke and therefore requires steam, some of the steam from the first cylinder is allowed to enter the second one, so that the second cylinder draws its steam direct from the first, instead of from a receiver; but it draws it at the middle of the stroke instead of at the end. This method may be applied easily to any existing

* A similar arrangement was introduced by me into a steamer in 1859, as a means of increasing the power by the addition of low pressure cylinders to the existing high pressure ones. The paddle-wheels were not connected; and one high and one low pressure cylinder placed nearly at right angles was set to turn each wheel. The steam passed from the high pressure cylinder not directly into the low pressure one, but into a reservoir which had pipes passing through it, which were heated by the escaping smoke in the manner steam is heated in a superheater.

engines. As a method of expansion it is only as efficacious as any other in the production of power. But its recommendation lies in the circumstance that the steam may be exhausted direct from one cylinder into the other, although the cranks are at right angles, and hence a large measure of expansion is producible in a pair of engines without increased complexity, without any risk of sticking on the centre, and with adequate equability of the rotative force.

Chaplin's Vertical Engine. Fig. 38 is a representation of the species of vertical engine and boiler constructed by Messrs. Chaplin & Co. of Glasgow. The waste steam maintains a strong draught in the furnace, and the steam is superheated somewhat before it enters the cylinder. The engine and boiler are erected upon a cast iron sole plate forming the ash pan, and into which water may be poured if desired. In some cases these engines are made with double cylinders; and besides being extensively employed for land purposes, they have been largely introduced into ships for pumping, hauling ropes, discharging cargo, &c. In many cases they are combined with a steam cooking apparatus, and a distilling apparatus for producing fresh from salt water; and the same fire which heats the cooking range also raises the steam in the boiler. The steam, in passing into the vessel in which it is condensed, sucks in sufficient air to aërate the water; and after being filtered by a filter attached to the condenser, it is then ready for use. In passenger ships the engine may be made to drive proper ventilating fans. I consider that every ship ought to be fitted with an engine, as it would

Fig. 38.

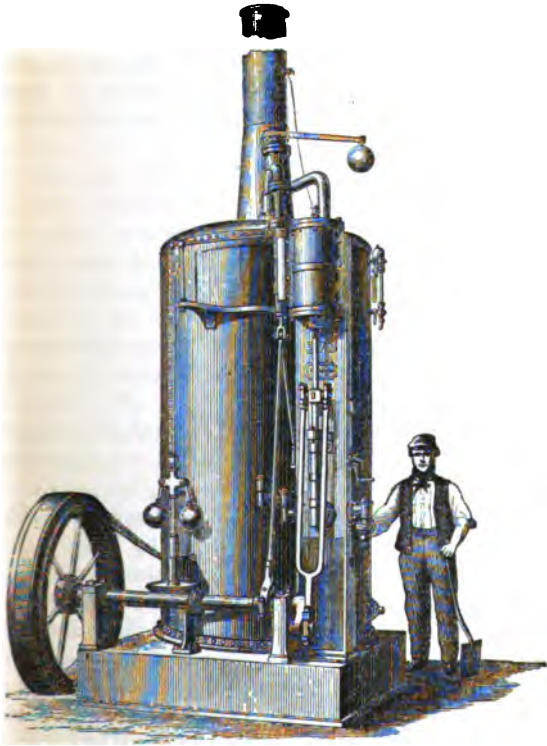

VERTICAL STEAM ENGINE BY CHAPLIN AND CO., GLASGOW.

increase the safety of the ship, reduce the labour, and add to the comfort of all on board, while it also might be made available, with a simple apparatus, for the slow propulsion of the ship in calms.

Steam Winches and Cranes. Steam winches are now very commonly employed for hoisting the cargo out of ships; and steam cranes have also obtained a wide introduction.

Fig. 39 represents Chaplin's steam crane as employed at the Great Exhibition to move heavy weights. The engine and boiler help to counterbalance the load, and they swing completely round the central pillar. The jib is adjustable; and the operations of hoisting, lowering, and swinging, are all performed by the engine. The best form of steam winch that I have seen is that constructed by Messrs. Day & Co. at Southampton.

One of the most powerful and convenient machines for lifting heavy weights yet constructed is the shears contrived by Mr. Summers, and made by Messrs. Day & Co. for the docks in Southampton; and several similar shears have since been constructed by Messrs. Day for other places. The legs of these shears are formed of boiler plate, and there are two legs meeting at the top in the usual manner; but instead of the back chains and guys usually employed, there is a third or back leg, by moving which inwards, the top of the shears is bent forward; and by moving which outwards, the top of the shears is bent back. The inward or outward motion of the third leg on the ground is governed by suitable apparatus; but that to which the preference is given is a great screw working horizontally, and drawing in or out the leg in appropriate guides. The

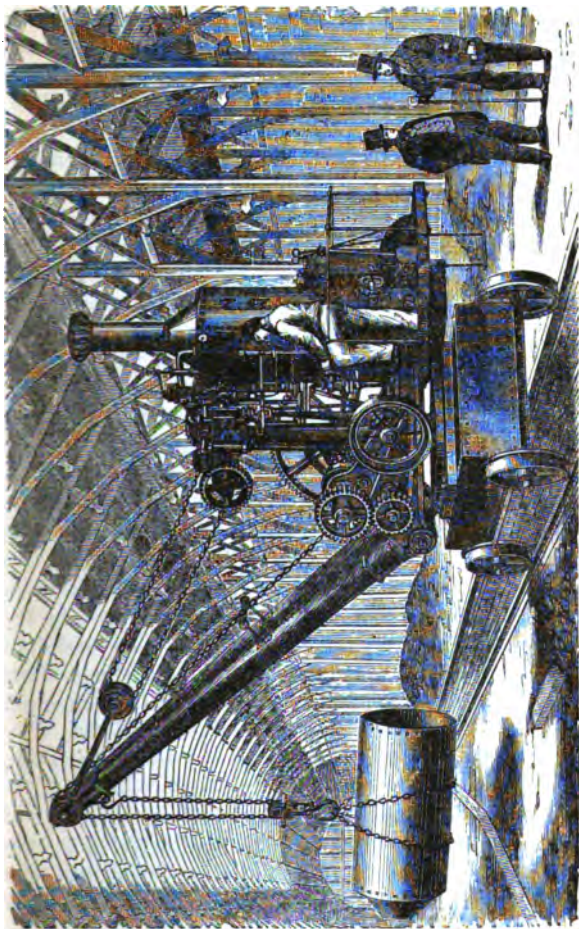

CHAPLIN'S STEAM CRANE AT THE GREAT EXHIBITION 1862.

P. 12. 30.

Southampton shears have lifted as much as 100 tons; and the hoisting and lowering, and also the movement of the back leg, is accomplished by a steam engine. The length of each front leg is 110 feet. The form is that of a parabolic spindle, 3 ft. 4 in. diameter in the middle, and 1 ft. 8 in. at the ends. The length of the back leg is 140 ft., and its form is rectangular, 40 in. by 46 in. at the middle, and 20 by 24 in. at the ends. The wrought iron screw which moves the back leg is $8\frac{1}{2}$ in. diameter, and 48 ft. 3 in. long. This screw moves the shears at the rate of 12 ft. per minute, and its weight at the middle is carried by a pendulum prop, which the back leg moves aside as it passes. The back leg is held down by the flanges of the grooves in which its lower end works. The main purchase blocks consist of a pair of 4-sheave blocks, with $1\frac{1}{2}$ chain-falls, and a leading-block above. These blocks are used for all weights over 20 tons, and hoist at the rate of about 4 ft. per minute. The light purchase-blocks have the same size of chain, but have only two sheaves above and one below. The engine which works this gear consumes about 6 cwt. of coal in the day; and the apparatus has been very successful in enabling a great deal of work to be done in a short time with superior accuracy, and at much less expense. Similar shears have been constructed by Messrs. Day & Co. for Hamburgh, Bremen, Bromley, Woolwich, and Holyhead.

Steam Riveting. Cylindrical boilers, and parts of other boilers, are now very generally riveted by the riveting machine, of which there are two forms—the one in which the die which forms the rivet head is

forced forward by a cam, in the same manner as the punch of a punching machine, and the other in which it is forced forward by a piston moving in a cylinder, in the same manner as a steam hammer. The latter species of machine is now most generally used.

The first machine-riveting, so far as I am aware, was performed by myself in 1834, and the next was performed by Mr. Fairbairn, who employed a similar form of apparatus, resembling a common punching machine. Garforth's steam hammer apparatus has this advantage, that the die does not require adjustment for the thickness of the plate.

Steam Hammers. The steam hammer was suggested by Watt, but was brought into its present form by Nasmyth, whose hammer as improved by Wilson is represented in *fig. 40*. *A* is the cylindrical valve chest by moving the valve in which the steam is let in above or below the piston, and the hammer is forced up or down. The valve is worked by the short horizontal spindle *B* passing through a stuffing-box; *D* is a bracket supporting the outer end of the valve spindle; *E* is a balanced lever, jointed to the rod *F* passing down by the side of the frame to the level of the attendant's hand. This rod is jointed at *G* to the bent lever *H*, which is suspended on the stud *I*, and which terminates in a handle at *H*. By moving this handle up the hammer is raised up, and by moving it down the hammer is pressed down; and in order that the inexperienced workman may not move it too far down, if a light blow is wanted, a guard sector *J* is placed for the handle to move in; and by putting the pin *K* in one of the holes of the sector,

Fig. 40.

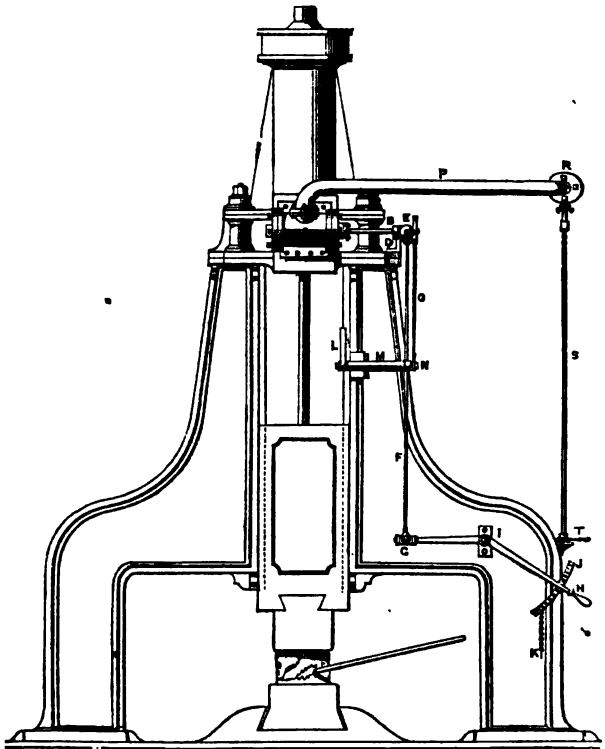

NASMYTH'S STEAM HAMMER.

and bringing the handle down to the pin, the proper blow answering to that position of the handle will be obtained.

The steam enters from the boiler through the pipe P, and there is a throttle valve at R, which is adjustable by the handle T.

In Condie's steam hammer the piston is stationary,

Figs. 41 and 42.

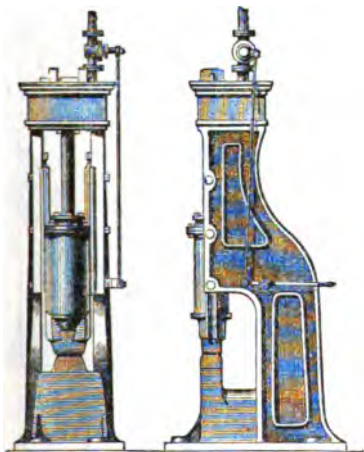

CONDIE'S $3\frac{1}{2}$ CWT. STEAM HAMMER, BY A. C. WYLIE, LONDON.

and the cylinder moves; and the piston rod is hollow and serves as a steam pipe to let the steam into and out of the cylinder. *Figs. 41, 42, 43, and 44,* are representations of Condie's Hammer, *figs. 41 and 42* being front and side views of a $3\frac{1}{2}$ cwt. hammer intended for smith

work for light forgings; and *figs. 43 and 44* being a front and side view of a 6 cwt. hammer intended for heavier

Figs. 43 and 44.

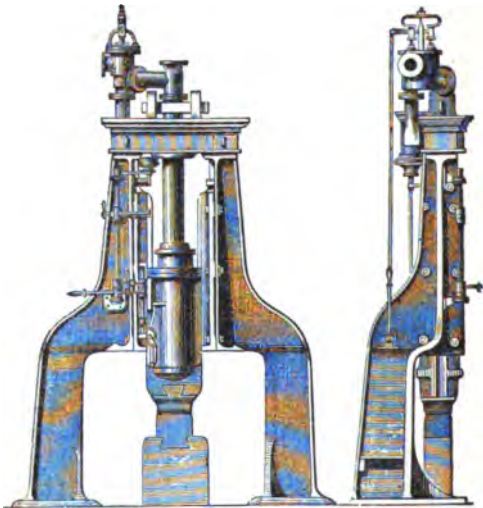

CONDIE'S 6 CWT. STEAM HAMMER, BY A. C. WYLIE, LONDON.

smith work or heavier forgings. In both of these hammers bars of any length may be welded, either along or across the anvil, and in the $3\frac{1}{2}$ cwt. hammer the anvil block is in the same piece as the framing. These hammers are all made double acting, being pressed down as well as raised up by the steam; and in practice they have been found to act in a highly satisfactory manner. *Figs. 45 and 46* are representa-

tions of the species of self-acting steam hammer constructed by Messrs. Carrett & Marshall of Leeds, *fig. 45* being a section of the cylinder and slide of the

Fig. 45.

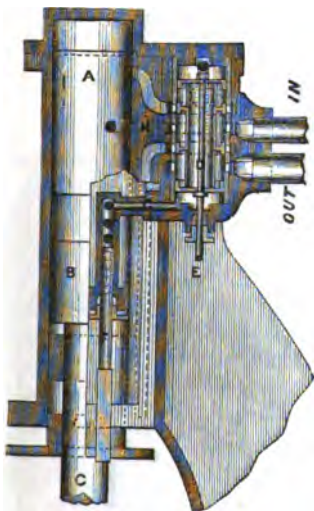

SECTION OF CYLINDER AND VALVE OF STEAM HAMMER.

hammer, and *fig. 46* a perspective view. In *fig. 45*, A is the cylinder, B is the piston, and C its rod; G is the regulating stop-slide, which adjusts the stroke by passing steam early or late from beneath the piston to under the piston-slide-valve D, which reverses the action of the steam on the piston, thus effecting the down-stroke. A suitable contraction

Fig. 46.

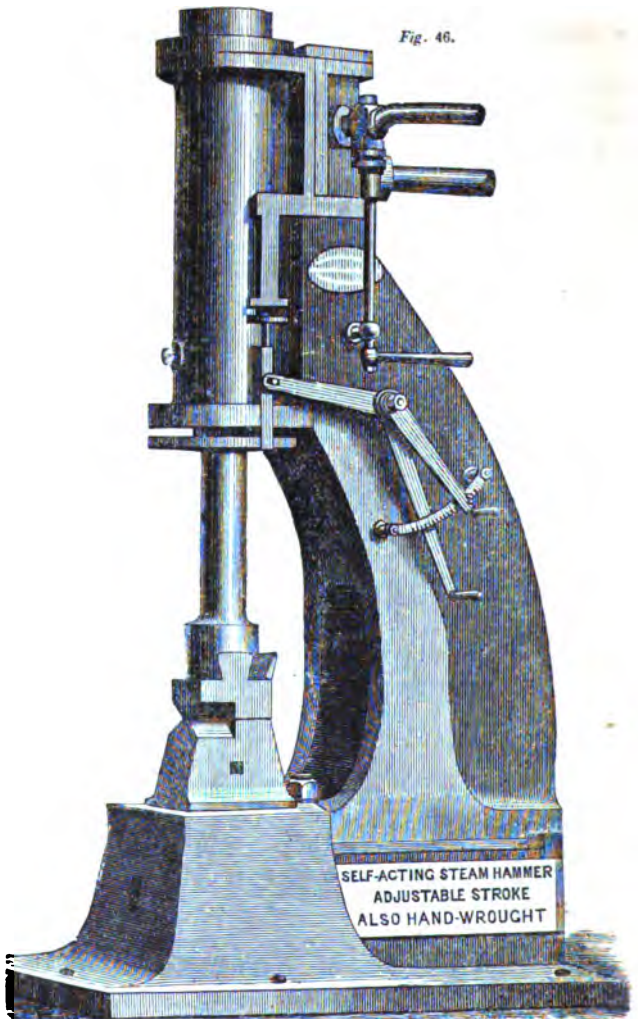

SELF-ACTING STEAM HAMMER BY CARRETT, MARSHALL AND CO., LREDS.

of the passage H regulates the strength of blow. The longer hand-lever regulates the stroke, and the other the strength of blow. E is the framing.

In this hammer the steam which works the hammer performs the office of moving the valve, being admitted above and below the piston-slide-valve, in the requisite quantity and for a suitable period of time, to give any required stroke, or a *light blow* with lead, or a *clear heavy blow* without lead, retaining the steam upon the piston until the blow is struck. There is a separate valve for working the hammer by hand.

Figs. 47 and 48 are representations of two different classes of steam hammer constructed by Messrs. Thwaites & Carbutt of Bradford, *fig. 47* being the form most appropriate for small hammers, and *fig. 48* that most appropriate for large. Messrs. Thwaites and Carbutt have had much experience in the construction of steam hammers, and for some time have made nothing else; and they state that they find that the hammers wrought by hand are preferred and are gradually taking the place of those wrought by self-acting mechanism, being under such easy and ready control. They state that they have made eighteen hammers for Messrs. Brown & Co. of Sheffield, the largest of which, a 15 ton. hammer, was made with wrought iron standards, and that they have now made several hammers with wrought iron standards, and believe that this method of construction will come into general use. In the manufacture of the Bessemer steel, hammers of 5, 8, and 12 tons are habitually required. When the standards are of cast iron, the box form is now preferred to the old T form, and

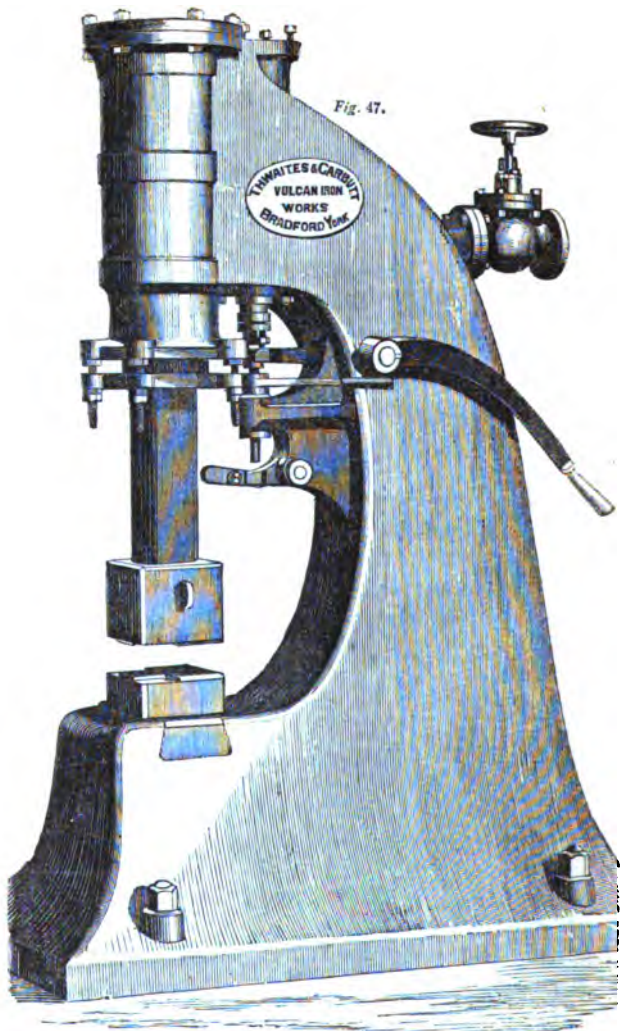

THWAITES AND CARBUTT'S HAMMER FOR SMALL FORGINGS.

Fig. 48.

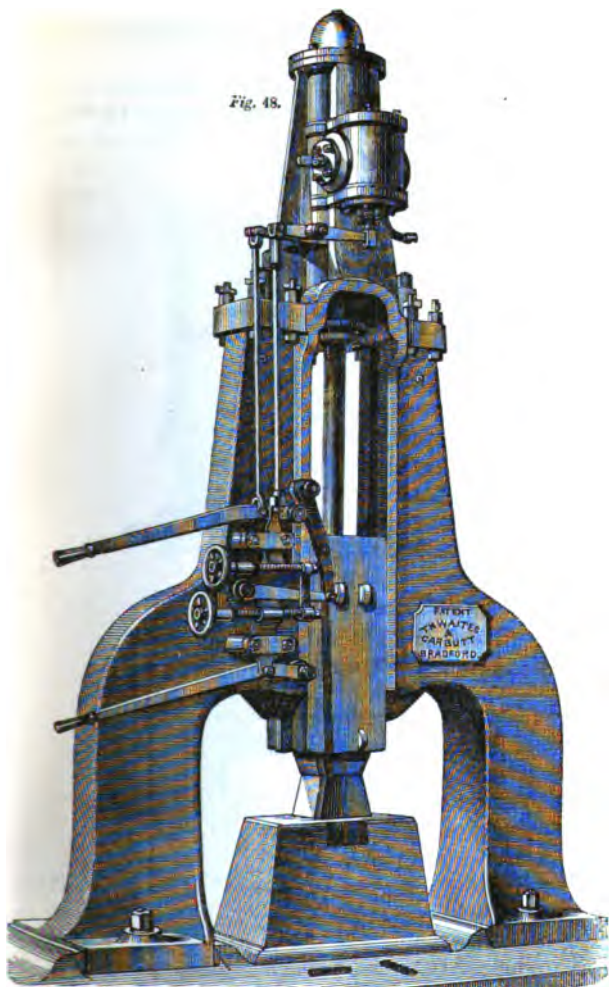

TWAINES AND CARBUTT'S HAMMER FOR HEAVY FORGINGS.

immense strength is necessary to enable the hammer permanently to endure the heavy shocks to which it

Fig. 49.

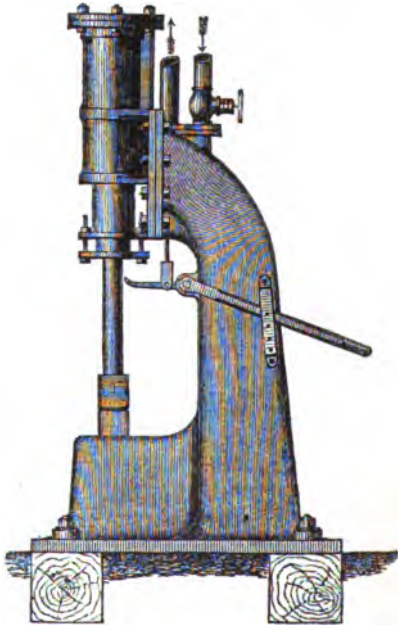

RIGBY'S STEAM HAMMER BY GLEN AND ROSS, GLASGOW.

is exposed. Messrs. Thwaites & Carbutt do not recommend hammers of the form shown in *fig. 47* for larger sizes than 12 cwt., and such hammers are very suitable for the work of the smith's shop. But above

that weight they recommend hammers with double standards, of the form shown in *fig. 48*, as being firmer and stiffer, and better suited for heavy work.

Fig. 50.

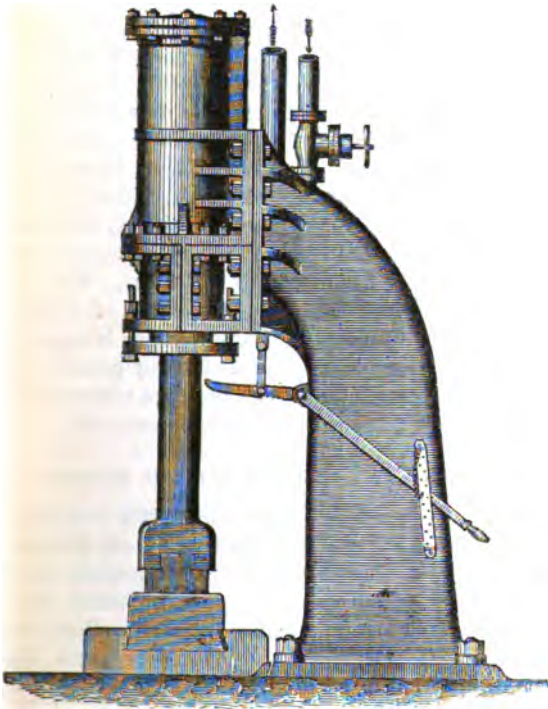

RIGBY'S STEAM HAMMER BY GLEN AND ROSS, GLASGOW.

These hammers are controlled in their movements

by two handles, one of which opens or shuts the stop valve, while the other gives motion to the working valve by which the steam is let into and out of the cylinder. This last valve is a balanced piston, so that it is quite easily moved, and the hammer is consequently under ready control.

Rigby's steam hammers, as constructed by Messrs. Glen & Ross of Glasgow, and represented in *figs.* 49 and 50, have obtained a very wide introduction, and have given much satisfaction to those employing them. *Fig.* 49 represents the form of hammer appropriate for light work, and which differs from the other form only in having the anvil-block, sole-plate, and standards cast in one piece. Hammers on this construction are made of 1, $2\frac{1}{2}$, and 4 cwt. The form of hammer represented in *fig.* 50 is made of different weights, from 6 to 30 cwt. The hammer is urged by the steam in its descent as well as by gravity, and works with great rapidity at a pressure of from 25 to 30 lbs., which pressure should not be exceeded.

GIFFARD'S INJECTOR FOR FEEDING BOILERS.

This is an instrument for forcing water into boilers by means of a jet of steam proceeding from the boiler itself; and its action is somewhat paradoxical, as it is capable of sending water into a boiler which has a considerably greater pressure of steam than that which the steam comes from. The feed water must not be hotter than 120° Fahrenheit, to enable the injector to act; for one condition of its action is that the steam shall be condensed; and this circumstance appears likely to restrict the use of the instrument—

Fig. 51.

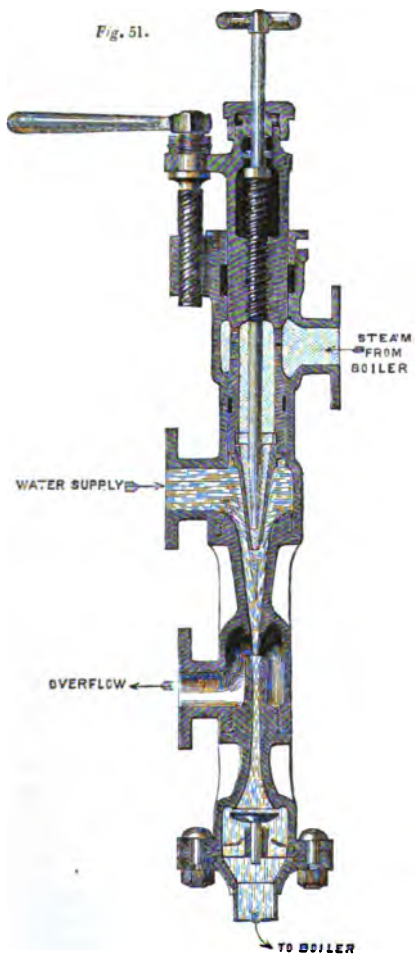

GIFFARD'S INJECTOR BY SHARP, STEWART AND CO., MANCHESTER.

unless suitably modified—as the feed water should certainly enter the boiler at the boiling point, to which it should be raised by heat otherwise going to waste. In this injector a stream of steam entering from the boiler at the highest nozzle, represented in *fig. 51*, is directed upon water entering the instrument through the nozzle next below; and as the whole power of the issuing steam has been expended in giving momentum to its own particles, that power, which cannot be destroyed, reappears as increased pressure, and forces the water into the boiler.* Should the water be shut off from the boiler as not being required, then it escapes, by the nozzle next beneath, through a loaded valve of the usual kind; and the valve at the bottom of the instrument prevents the return of the water when the instrument is not in use. The advantage of this apparatus is that it gets rid of the feed pump with its valves, which have been a source of constant trouble in engines working at a high speed. But unless it can be so modified as to send the feed water into the boiler at the boiling point to which it will be heated by the waste heat of the engine, I do not see how this injector can be retained as a main feeding instrument, though it will always be valuable as an auxiliary.

The sizes and prices of different injectors, proper for sending any desired number of gallons of water into a boiler in the hour, are given in the following table:—

* The injector is virtually a hydraulic ram reversed, in which the small quantity of water in the steam, moving at a high velocity, forces a larger quantity of water against a lower head.

DELIVERY OF WATER BY GIFFARD'S INJECTOR.
 The following Table shows the Sizes and Prices of Giffard's Injectors, and the number of Gallons per hour they are capable of supplying to a Boiler, according to the pressure per square inch of steam employed, with a considerable margin for contingencies, especially in the smallest sizes:—

Diameter of Injectors in Inches.	No. of Injectors in Boiler.	Price in the Works—Per Inch.	Pressure of Steam in pounds per square inch.										Diameter of Injectors in Inches.	No. of Injectors in Boiler.	Price in the Works—Per Inch.																																																																																																																																																																																																																																																																																																																																																																																																																																																																																																																																																																																																																																																																																																																																																																																																																																																																																																																																																																																																																																																																																																																																																																																																																																																				
			10 lbs.	20 lbs.	30 lbs.	40 lbs.	50 lbs.	60 lbs.	70 lbs.	80 lbs.	90 lbs.	100 lbs.				110 lbs.	120 lbs.	130 lbs.	140 lbs.																																																																																																																																																																																																																																																																																																																																																																																																																																																																																																																																																																																																																																																																																																																																																																																																																																																																																																																																																																																																																																																																																																																																																																																																																																																
2	9	20	28	35	40	47	49	53	57	60	64	67	70	73	75	78	81	84	87	90	93	96	99	102	105	108	111	114	117	120	123	126	129	132	135	138	141	144	147	150	153	156	159	162	165	168	171	174	177	180	183	186	189	192	195	198	201	204	207	210	213	216	219	222	225	228	231	234	237	240	243	246	249	252	255	258	261	264	267	270	273	276	279	282	285	288	291	294	297	300	303	306	309	312	315	318	321	324	327	330	333	336	339	342	345	348	351	354	357	360	363	366	369	372	375	378	381	384	387	390	393	396	399	402	405	408	411	414	417	420	423	426	429	432	435	438	441	444	447	450	453	456	459	462	465	468	471	474	477	480	483	486	489	492	495	498	501	504	507	510	513	516	519	522	525	528	531	534	537	540	543	546	549	552	555	558	561	564	567	570	573	576	579	582	585	588	591	594	597	600	603	606	609	612	615	618	621	624	627	630	633	636	639	642	645	648	651	654	657	660	663	666	669	672	675	678	681	684	687	690	693	696	699	702	705	708	711	714	717	720	723	726	729	732	735	738	741	744	747	750	753	756	759	762	765	768	771	774	777	780	783	786	789	792	795	798	801	804	807	810	813	816	819	822	825	828	831	834	837	840	843	846	849	852	855	858	861	864	867	870	873	876	879	882	885	888	891	894	897	900	903	906	909	912	915	918	921	924	927	930	933	936	939	942	945	948	951	954	957	960	963	966	969	972	975	978	981	984	987	990	993	996	999	1002	1005	1008	1011	1014	1017	1020	1023	1026	1029	1032	1035	1038	1041	1044	1047	1050	1053	1056	1059	1062	1065	1068	1071	1074	1077	1080	1083	1086	1089	1092	1095	1098	1101	1104	1107	1110	1113	1116	1119	1122	1125	1128	1131	1134	1137	1140	1143	1146	1149	1152	1155	1158	1161	1164	1167	1170	1173	1176	1179	1182	1185	1188	1191	1194	1197	1200	1203	1206	1209	1212	1215	1218	1221	1224	1227	1230	1233	1236	1239	1242	1245	1248	1251	1254	1257	1260	1263	1266	1269	1272	1275	1278	1281	1284	1287	1290	1293	1296	1299	1302	1305	1308	1311	1314	1317	1320	1323	1326	1329	1332	1335	1338	1341	1344	1347	1350	1353	1356	1359	1362	1365	1368	1371	1374	1377	1380	1383	1386	1389	1392	1395	1398	1401	1404	1407	1410	1413	1416	1419	1422	1425	1428	1431	1434	1437	1440	1443	1446	1449	1452	1455	1458	1461	1464	1467	1470	1473	1476	1479	1482	1485	1488	1491	1494	1497	1500	1503	1506	1509	1512	1515	1518	1521	1524	1527	1530	1533	1536	1539	1542	1545	1548	1551	1554	1557	1560	1563	1566	1569	1572	1575	1578	1581	1584	1587	1590	1593	1596	1599	1602	1605	1608	1611	1614	1617	1620	1623	1626	1629	1632	1635	1638	1641	1644	1647	1650	1653	1656	1659	1662	1665	1668	1671	1674	1677	1680	1683	1686	1689	1692	1695	1698	1701	1704	1707	1710	1713	1716	1719	1722	1725	1728	1731	1734	1737	1740	1743	1746	1749	1752	1755	1758	1761	1764	1767	1770	1773	1776	1779	1782	1785	1788	1791	1794	1797	1800	1803	1806	1809	1812	1815	1818	1821	1824	1827	1830	1833	1836	1839	1842	1845	1848	1851	1854	1857	1860	1863	1866	1869	1872	1875	1878	1881	1884	1887	1890	1893	1896	1899	1902	1905	1908	1911	1914	1917	1920	1923	1926	1929	1932	1935	1938	1941	1944	1947	1950	1953	1956	1959	1962	1965	1968	1971	1974	1977	1980	1983	1986	1989	1992	1995	1998	2001	2004	2007	2010	2013	2016	2019	2022	2025	2028	2031	2034	2037	2040	2043	2046	2049	2052	2055	2058	2061	2064	2067	2070	2073	2076	2079	2082	2085	2088	2091	2094	2097	2100	2103	2106	2109	2112	2115	2118	2121	2124	2127	2130	2133	2136	2139	2142	2145	2148	2151	2154	2157	2160	2163	2166	2169	2172	2175	2178	2181	2184	2187	2190	2193	2196	2199	2202	2205	2208	2211	2214	2217	2220	2223	2226	2229	2232	2235	2238	2241	2244	2247	2250	2253	2256	2259	2262	2265	2268	2271	2274	2277	2280	2283	2286	2289	2292	2295	2298	2301	2304	2307	2310	2313	2316	2319	2322	2325	2328	2331	2334	2337	2340	2343	2346	2349	2352	2355	2358	2361	2364	2367	2370	2373	2376	2379	2382	2385	2388	2391	2394	2397	2400	2403	2406	2409	2412	2415	2418	2421	2424	2427	2430	2433	2436	2439	2442	2445	2448	2451	2454	2457	2460	2463	2466	2469	2472	2475	2478	2481	2484	2487	2490	2493	2496	2499	2502	2505	2508	2511	2514	2517	2520	2523	2526	2529	2532	2535	2538	2541	2544	2547	2550	2553	2556	2559	2562	2565	2568	2571	2574	2577	2580	2583	2586	2589	2592	2595	2598	2601	2604	2607	2610	2613	2616	2619	2622	2625	2628	2631	2634	2637	2640	2643	2646	2649	2652	2655	2658	2661	2664	2667	2670	2673	2676	2679	2682	2685	2688	2691	2694	2697	2700	2703	2706	2709	2712	2715	2718	2721	2724	2727	2730	2733	2736	2739	2742	2745	2748	2751	2754	2757	2760	2763	2766	2769	2772	2775	2778	2781	2784	2787	2790	2793	2796	2799	2802	2805	2808	2811	2814	2817	2820	2823	2826	2829	2832	2835	2838	2841	2844	2847	2850	2853	2856	2859	2862	2865	2868	2871	2874	2877	2880	2883	2886	2889	2892	2895	2898	2901	2904	2907	2910	2913	2916	2919	2922	2925	2928	2931	2934	2937	2940	2943	2946	2949	2952	2955	2958	2961	2964	2967	2970	2973	2976	2979	2982	2985	2988	2991	2994	2997	3000	3003	3006	3009	3012	3015	3018	3021	3024	3027	3030	3033	3036	3039	3042	3045	3048	3051	3054	3057	3060	3063	3066	3069	3072	3075	3078	3081	3084	3087	3090	3093	3096	3099	3102	3105	3108	3111	3114	3117	3120	3123	3126	3129	3132	3135	3138	3141	3144	3147	3150	3153	3156	3159	3162	3165	3168	3171	3174	3177	3180	3183	3186	3189	3192	3195	3198	3201	3204	3207	3210	3213	3216	3219	3222	3225	3228	3231	3234	3237	3240	3243	3246	3249	3252	3255	3258	3261	3264	3267	3270	3273	3276	3279	3282	3285	3288	3291	3294	3297	3300	3303	3306	3309	3312	3315	3318	3321	3324	3327	3330	3333	3336	3339	3342	3345	3348	3351	3354	3357	3360	3363	3366	3369	3372	3375	3378	3381	3384	3387	3390	3393	3396	3399	3402	3405	3408	3411	3414	3417	3420	3423	3426	3429	3432	3435	3438	3441	3444	3447	3450	3453	3456	3459	3462	3465	3468	3471	3474	3477	3480	3483	3486	3489	3492	3495	3498	3501	3504	3507	3510	3513	3516	3519	3522	3525	3528	3531	3534	3537	3540	3543	3546	3549	3552	3555	3558	3561	3564	3567	3570	3573	3576	3579	3582	3585	3588	3591	3594	3597	3600	3603	3606	3609	3612	3615	3618	3621	3624	3627	3630	3633	3636	3639	3642	3645	3648	3651	3654	3657	3660	3663	3666	3669	3672	3675	3678	3681	3684	3

The construction of these injectors is a special branch of manufacture; and in applying to the manufacturer for any suitable size, it is necessary to state the number and description of the boilers for which the injectors are intended, and also to state whether they are to have a brass or cast iron casing, as this last condition will affect the price.*

Delabarre's Steam Jet. This is an arrangement for increasing the efficiency of a steam jet in chimneys. The jet orifice is surrounded by a short piece of pipe of larger diameter, and it by another short piece of still larger diameter, and it by another short piece still larger, and so on as far as is deemed desirable. These short pieces of pipe are all open at each end like ferrules, and the length of each is about equal to its diameter. The bottom of each is set on a level with the top of the preceding one, and the bottom of each is slightly belled out to intercept the smoke. A jet of this kind placed in a chimney is believed to be more effectual than a common jet, which will ascend the centre of the chimney without much affecting the surrounding smoke; whereas by this arrangement each succeeding pipe transforms the jet preceding it into a

* The following formula is given for determining the size or delivery of a Giffard's injector: If P be the pressure of the steam in atmospheres, D the diameter of the throat in inches, and G the number of gallons delivered per hour, then $G = (63.4 D)^2 \sqrt{P}$ and $D = .0158 \sqrt{\frac{G}{\sqrt{P}}}$. Thus if the pressure of steam be 60 lbs. or 4 atmospheres, and the number of gallons to be delivered per hour be 308, then $.0158 \sqrt{\frac{308}{\sqrt{4}}} = .0158 \sqrt{154} = .0158 \times 12.4 = .19592 = \text{diameter in inches} = 5 \text{ millimetres, as in the table.}$

new jet of less velocity and larger volume, until at length the whole column of smoke in the chimney is brought under the influence of the central jet.

On the benefit of Steam Jackets. The benefit of steam jackets round cylinders was ascertained by Watt, and such jackets were habitually used by him. But among succeeding engineers, jackets fell into disuse, as it was hastily and erroneously concluded that the waste by radiation was the only loss incident to the cooling of the cylinder, and that this loss would be as great in the jacket as in the cylinder. This error has now been for some years exploded. Nevertheless, although some few engineers have long urged the application of steam jackets to marine and locomotive engines, it is only very recently that jackets have been adopted by the best marine engine builders, and they are not even yet used in locomotives. One reason of this tardiness of amelioration is no doubt the fact, that steam jackets add something to the cost of the engine; and their full value, moreover, has not been sufficiently known or understood, since the whole question has been believed to be one of radiation, whereas the loss is by no means measurable by the loss from radiation, but is a much larger loss, and arises from the fact of the inner surface of the cylinder being cooled and heated by the steam at every stroke of the engine. This action is clearly demonstrated by a set of indicator figures taken in 1848, and kindly lent to me by Mr. E. A. Cowper. Four of these diagrams are represented in *figs.* 52, 53, 54, and 55, and they show the pressure really attained, together with the true expansion curve for the whole

quantity of steam that entered the cylinder, dotted in, and which dotted curve would have been described

Fig. 52.

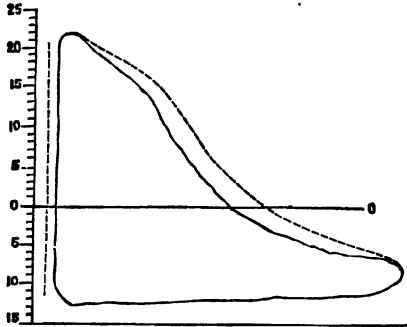

DIAGRAM SHOWING LOSS BY COOLING.

Fig. 53.

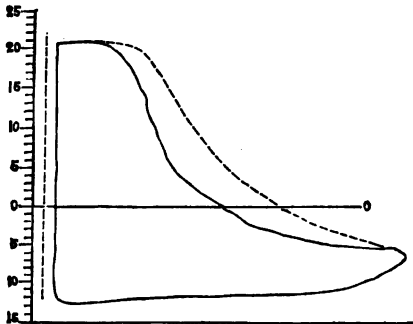

DIAGRAM SHOWING LOSS BY COOLING.

if the cylinder had been jacketed. The difference

between these curves represents the amount of loss from the want of the steam jacket; and in *fig 52* this loss amounts to 11.7 per cent. ; in *fig. 53* to 19.66 per

Fig. 54.

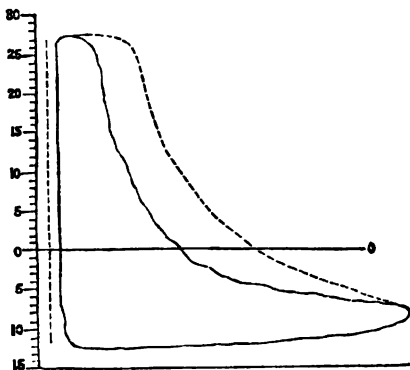

DIAGRAM SHOWING LOSS BY COOLING.

Fig. 55.

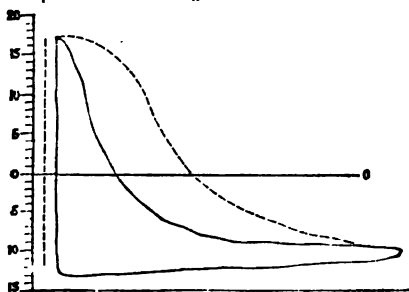

DIAGRAM SHOWING LOSS BY COOLING.

cent., there being rather more variation of temperature in this case, owing to there being more expansion ; in *fig. 54* the loss is 27·27 per cent. ; whilst in *fig. 55* the loss rises to the formidable proportions of 44·58 per cent. This loss is caused by the circumstance that the mass of the cylinder must remain at the average temperature intermediate between the highest and the lowest temperatures of the steam ; so that when high pressure steam, which also has a high temperature, enters the cylinder, a considerable quantity of steam is at once condensed, owing to the abstraction of heat by the metal, and also to the transformation of a part of the heat into mechanical power. So soon as the steam is cut off and allowed to expand, it falls much more rapidly in pressure than answers to its augmented volume, owing to still more of it being condensed into water. The action of the steam is to heat the inner surface of the cylinder ; and towards the end of the stroke, when the steam is much lower in pressure, and consequently in temperature, than it was at first, the temperature of the cylinder relatively with it is sufficiently high to boil off the water that was condensed from the steam as it entered the cylinder ; and such water becoming steam causes the pressure to rise, and thus the curve approaches the true expansion curve at the end of the stroke. The cylinder is cooled by the loss of the heat used in boiling off the water shut within it, and the cooled cylinder condenses the next volume of steam that enters to perform the next stroke. Thus it follows, that without steam jackets a large quantity of steam passes through the cylinder in the form of water, without doing work ;

whereas if the cylinder is steam jacketed, no condensation takes place, and the whole steam does its full duty according to the degree to which it is expanded. Indeed, without steam jackets, or hot air jackets, or other equivalent means of keeping up the temperature of the cylinder, it will follow that the cylinder will act to some extent as a condenser at the beginning of the stroke, and as a boiler at the end of the stroke.

MARINE ENGINES.

In illustrating the special features of the various forms of marine engines of modern construction, the most convenient course will be to take an example of an engine by each principal maker, and to describe its structure and peculiarities. A tolerably just conception will thus be arrived at of the present condition of marine engineering in this country in its most perfect form, care being taken that the examples selected are good and recent examples of their several kinds.

Boulton & Watt. The example of modern engines by these makers that I shall select is the oscillating paddle engines of the Holyhead steamers, Ulster and Munster; for although I might have selected a still more recent example, I could not have selected a more perfect one. These vessels have now been plying regularly across the channel at all seasons for a sufficient time thoroughly to test their qualities, and they have been found to maintain a very high speed and to work in a most satisfactory manner. The vessels are each 328 ft. long, with 35 ft. breadth of beam, 21 ft. depth of hold, and they each measure about 2,000 tons, builder's measurement. Each vessel

is propelled by two oscillating engines of 96 in. diameter of cylinder, and 7 ft. stroke. The pressure of steam in the boiler is 26 lbs. per sq. in. The nominal power of each pair of engines by the Admiralty rule is 750 horses. They make 23 strokes per minute, and they work up to 4,100 actual or indicated horses power.

The boilers are tubular boilers with iron tubes; they are made in eight parts, and contain in all 48 furnaces. The total heating surface of the boiler is 18,400 sq. feet, and the total area of grate bars is 840 sq. ft. The area of the immersed midship section of the vessel is 350 sq. ft. and the coefficient of performance 860. The draught of water of each of the vessels when launched was: forward, 9 ft. 3 in.; and aft, 8 ft. 2 in. The draught of water with the engines, boilers, masts, and fittings, on board, but without water in the boilers, was, forward, 12 ft., and aft, 12 ft. 6 in. The draught of water when ready for sea, and complete with stores, and 75 tons of coals, was, forward, 13 ft., and aft, 13 ft. 4 in. The weight of the engines is 220 tons, of the boilers 230 tons, of the water in the boilers, 170 tons, and of the paddle wheels, 110 tons: making a total weight of 730 tons, or nearly 1 ton per nominal horse power. The pistons are each made with a metallic ring pressed out by springs. The average pressure on the piston is 28.77 lbs. per sq. in. The total number of tubes in the boilers 4,240, of $2\frac{1}{2}$ in. diameter, 5 ft. 3 in. long, and $\frac{1}{8}$ th thick. The tube plates are of iron $\frac{3}{4}$ in. thick, and the tubes are $1\frac{1}{4}$ in. distant from each other. The length of each furnace is 7 ft., and its breadth $2\frac{1}{2}$ ft. There are two sets of

boilers in each vessel, one before and the other behind the engines, and each set has a chimney $7\frac{1}{2}$ ft. diameter and $44\frac{1}{2}$ ft. high above the grates. The paddle wheels are, feathering, 33 ft. 9 in. diameter to the inner edge of the outer ring. There are 14 floats in each wheel, and each float is 4 ft. deep and 12 ft. long. The dip of the wheels is 5 ft. 9 in. at deep draught. The steam is superheated by passing up and down through annular steam chests surrounding the chimneys, divisions being introduced into the annular space to compel the steam to ascend and descend before escaping to the steam pipe. A similar arrangement had been introduced by me into the Don Juan steamer as far back as 1836. These vessels, and two similar vessels, the Leinster and Connaught, the engines of which were constructed by Messrs. Ravenhill, Salkeld & Co., have realised a speed of upwards of 20 miles an hour, and an average speed in all weathers, during the first six winter months, of 18 miles an hour. In the Leinster and Connaught the cylinders are 98 in. diameter, and 6 ft. 6 in. stroke, and the engines are rated at 720 nominal horses power, but are in reality 770 nominal horses power. There are eight boilers, containing 40 furnaces and 4176 tubes, and a total heating surface of 16,800 sq. ft. At the official trial the engines, with a pressure of steam of 20 lbs., made from 25 to 26 revolutions per minute, and exerted 4,751 actual horses power. The consumption of fuel is about 3 lbs. per indicated horse power per hour.

John Penn & Son. The engines of these makers which I shall select for illustration are the engines of

the Warrior, Black Prince, and Achilles—all horizontal trunk engines of the construction represented at page 79 of my 'Catechism of the Steam Engine.'

These engines are each of 1,250 horse-power, and notwithstanding their immense size, they are distinguished by the same beauty and accuracy of workmanship for which Messrs. Penn's engines have long been famous. The cylinders are of 112 in. in diameter, and 4 ft. stroke. The trunks are of 41 in. diameter, which reduces the effective diameter of the cylinders to $104\frac{1}{2}$ in. The air pumps are double acting, 36 in. diameter, and 4 ft. stroke. The feed and bilge pumps are $7\frac{1}{2}$ in. diameter; the crank shaft is of 19 in. diameter, and the screw shafting is of 17 in. diameter. The screw, which is on Griffith's plan, is $24\frac{1}{2}$ ft. diameter, and 30 ft. pitch. There are two engines in each vessel, and they make about 45 revolutions per minute; there are 10 boilers in each vessel, and each of these boilers has 4 furnaces in it 7 ft. 3 in. long, and 3 ft. wide. The tubes are of brass, $2\frac{3}{4}$ outside diameter, and 6 ft. 8 in. long, and there are 440 tubes in each boiler, or 4,400 tubes in all. The smoke is carried off by two funnels on the telescopic principle, 7 ft. 6 in. diameter, and 54 ft. above the bars of the grate.

The Warrior and Black Prince are both iron vessels of 6,039 tons burden, built of iron, and covered with two thicknesses of teak, over which are bolted armour plates of iron 4 in. thick, and ploughed and tongued at the edges to enable each plate to give mutual support to those next it in the event of strain or shock. With an immersed midship section of 1,200 sq. ft.,

and a pressure of steam in the boilers of 22 lbs. per sq. in. these vessels exerted about 5,400 actual horsepower, and attained a speed of $14\frac{1}{2}$ knots—the engines making 55 revolutions per minute.

Messrs. Ravenhill, Salkeld & Co. The form of screw engines employed by Messrs. Ravenhill, Salkeld & Co. is represented in *fig. 56*. This form of engine is a horizontal steeple engine of the same type as that of the *Amphion*, the engines of which, designed by the late Mr. Holm,* were constructed by Messrs. Miller, Ravenhill & Co. The *Amphion* was the first vessel built in this country with the engines below the water-line; and the species of engine with which she was fitted appears to me the best species of screw engine yet introduced, and one which perfectly satisfies the existing necessities of screw propulsion. There were faults of detail in the engines of the *Amphion* which have been subsequently corrected; and in the best examples of this form of engine a very perfect result is exhibited.

In the example shown in *fig. 56* there are two cylinders placed side by side with their axes running athwart-ships in the vessel; and the cylinders are on one side of the vessel, and the condensers and air pumps on the other side. Two great pipes extending across the engine conduct the exhaust steam from the cylinders to the condensers. There are two long piston rods passing one above the shaft and the other below to the cross head which moves in guides on top of the

* The engines of the French frigate *Pomone* were also designed by Mr. Holm, who was a Swedish engineer of great ability.

Fig. 51.

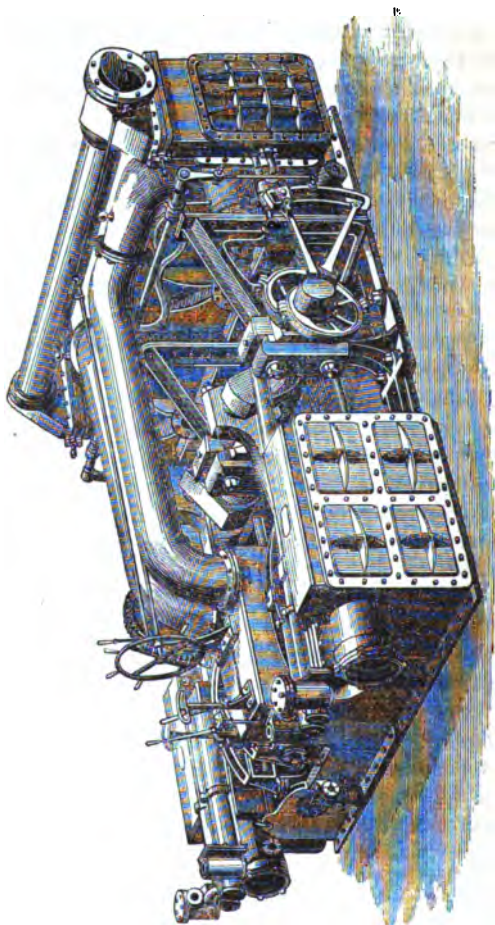

DIRECT-ACTING SCREW ENGINE BY RAYENHILL, SALKELD AND CO.

condenser, and from which a return connecting rod proceeds to the crank to turn it round. The various subordinate features of the arrangement are made so plain by a reference to the drawing that it is needless to enlarge on them further.

Maudslay, Sons & Field. Messrs. Maudslay and Field have long employed a species of engine similar to the foregoing; but latterly they have made their screw engines with three cylinders instead of two, with the object of reconciling equability of motion with a high speed and a large measure of expansion. The aggregate capacity of these three cylinders is about half or three quarters larger than the two ordinarily used for the same power. This is for the purpose of using the steam more expansively. The steam is shut off much earlier in the stroke than heretofore. Six efforts are given in each revolution, which gives more uniform motion to the screw shaft, and the whole is so completely balanced that the unpleasant agitation felt in screw vessels at high speeds is entirely removed. The steam is superheated; the cylinders are cased all round and at both ends, and this case is filled with superheated steam, which keeps the cylinder up to the maximum temperature. The steam is condensed by surface condensers, having small perpendicular tubes — the cooling surface being about the same as the heating surface of the boiler. A still is provided to make up the waste. The cold water is forced amongst the outsides of the tubes by a pump, and is so directed that it all enters at the lower edge all round, and also in the centre of the cluster; then rising it is driven out at the upper edge of the tubes.

The superheating apparatus is composed of a number of horizontal tubes round at the end where they are fitted into a tube plate, but flattened throughout the greater part of their length. By these means the steam is greatly subdivided, and more effectually presented to the action of the heat, and more room is also afforded for the smoke to pass between them. To enable any of the tubes to be replaced when worn or leaky, the central tube of each group of nine is made oval at one end, to admit of any of the nine tubes of the group being introduced or withdrawn. One end of the tube intended to fit this hole has a flange and is fitted with four screws.

The boilers are of the usual tubular kind; they work at 20 to 25 lbs. pressure. The feed water is heated in its passage back into the boiler. Care has been taken that there should be as little waste of steam as possible in the passages between the slide and the cylinder; and the length of this passage is reduced by using two small slides instead of one large one to each cylinder. The expansion is effected by the slide alone. The slide valves, which are long and three-ported, are moved by a three-throw crank or eccentric; and the openings are large, while the travel is very small. The eccentrics are driven by a small spur wheel on the main shaft, and a similar wheel on the eccentric shaft. These wheels are connected by a pair of intermediate wheels fixed in a rising and falling frame. The elevation or depression of these wheels has the effect of altering the position of the eccentrics relatively with that of the main crank, and thus effects the forward and backward motion of the

engine ; and it also adjusts the degree of expansion within the limits of $\frac{1}{4}$ th and $\frac{1}{2}$ th of the stroke. This engine combines all the well-established sources of economy in the steam engine. The workmanship is of the very first quality ; and the whole is of great strength and solidity. The thrust bearing is formed of collars on the shaft, but set wider apart than is usual ; and each collar has a horse-shoe plate applied to it to take a proportion of the thrust. There are 5 or 6 of these collars and plates ; each plate is adjustable by screws and admits of being separately taken out and replaced, and this can be done while the engine is working. A set of these engines of 500 horse-power has been fitted by Messrs. Maudslay in the steam frigate Octavia. Each of the three cylinders is 66 in. diameter, and the length of the stroke is 3 ft. 6 in. The valves are double-ported ; each condenser is fitted with $5\frac{1}{2}$ miles of $\frac{1}{2}$ in. copper tubing (No. 18 wire gauge), and the circulating pumps, which are fitted with *lignum vitæ* packing, are worked by arms from the cross-heads. The Octavia is a vessel of 3,161 tons ; and at the official trial in 1861 she realised a speed of $12\frac{1}{4}$ knots with a displacement of 2,921 tons, an immersed midship section of 552 sq. ft., a pressure of steam of 20 lbs., $69\frac{1}{2}$ revolutions, and an indicated power of 2,265 horses. The consumption of coal was only $2\frac{1}{4}$ lbs. per indicated horse power.

Messrs. Robert Napier & Sons. The engines of the steamer Scotia for the Cunard line, by Messrs. Napier of Glasgow, are of the side lever description, and the cylinders are 100 in. in diameter, and 12 ft.

stroke. The parts of these engines are of enormous strength, and their general configuration is the same as that of the side-lever engines usually constructed by Messrs. Napier, except that the side levers are of wrought iron, and the slide valves, which are of the short D kind, connected with three rods, have metallic packing at the back, consisting of a cast iron segment cut obliquely at the centre, and accurately fitted to the back of the valve. There are two such segments opposite to each port with a space between them equal to the depth of the port, the purpose of which is to put the valve into equilibrium, whereby it is more easily worked. This improvement is due to Mr. Waddell; and it has been found to be useful and efficient in practice. The sole plate, condenser, and air pump of each engine are all cast in one piece; and the air pumps after being bored out are lined with brass chambers. The cylinders are formed with double bottoms, and the whole structure of the engine is of the most conscientious and substantial character.

One form of screw engine employed by Messrs. Napier is the horizontal steeple kind very similar to that employed by Messrs. Ravenhill and Messrs. Maudslay. But they also occasionally use, in the case of merchant steamers, inverted engines of the forge hammer type similar to those employed by Messrs. Caird, of which a description is given at page 126. An example of Messrs. Napier's horizontal engine is given in *fig. 57*, which is a representation of the engines of the armour-plated steamer Rolf Krake, constructed by Messrs. Napier & Sons for the Danish navy. In the first examples of this species of engine,

Fig. 57

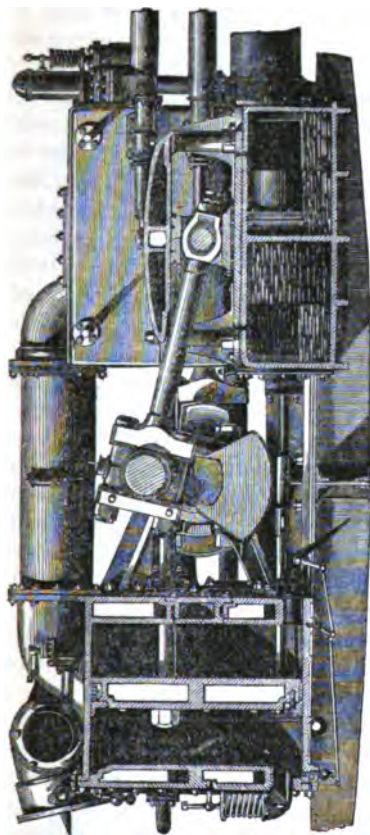

ENGINES OF THE DANISH ARMOUR-PLATED VESSEL ROLFE KRAKE, CONSTRUCTED BY NAPIER & SON, GLASGOW.

constructed by Messrs. Napier, the piston rods, instead of being attached to a cross head moving in guides, were attached to a great plunger which constituted the bucket of the air pump; and from the bottom of this plunger, which was cast open at one end like a trunk, the connecting rod proceeded to turn the crank. But this plan is much inferior in simplicity and eligibility to that which Messrs. Napier have since adopted, as shown in *fig. 57*, and which, in the application of counter weights and otherwise, resembles the form of engine introduced by me in 1852.

Messrs. Day & Co. The screw engine of Messrs. Day & Co. of Southampton is also of the horizontal steeple variety, but in most of the details it is the most judiciously arranged engine I have met with. A representation of Messrs. Day's engine is given in *fig. 58*, which is engraved from a photograph of the engines of the steam screw yacht *Brilliant*, of 100 horse power, constructed by Messrs. Day. This vessel is 191 ft. long, 21 ft. broad, and of 419 tons builder's measurement. There are two engines, each with a cylinder 40 in. diameter, and 2 ft. stroke; and with a pressure of steam in the boiler of 20 lbs., and a vacuum in the condenser of 27 in. of mercury. The engines make 90 revolutions per minute, and exert 510 horse power. *Fig. 59* contains two indicator diagrams taken from one of the engines, one diagram being taken from the cylinder on one side of the piston and the other diagram from the other side.

It will be seen by a reference to *fig. 58* that the cylinders lie on the one side of the screw shaft, and the condensers on the other, as is the common arrange-

Fig. 58.

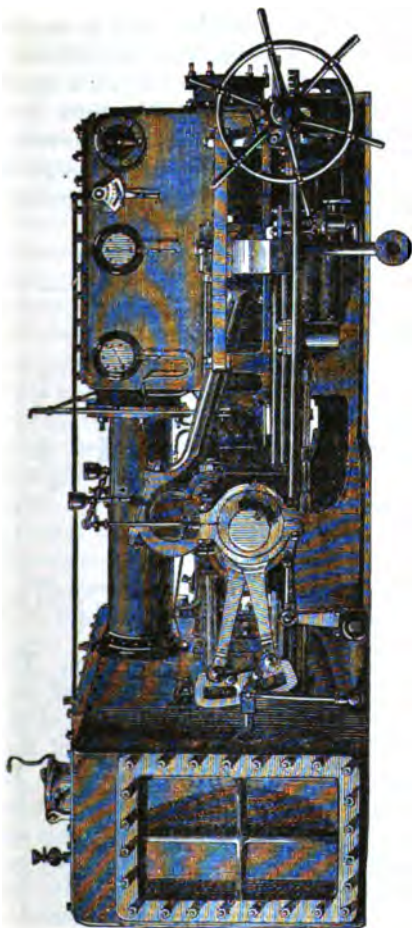

HORIZONTAL SCREW ENGINES OF THE STEAM YACHT BRILLIANT, BY MESSRS. DAY AND CO., SOUTHAMPTON.

ment in this class of engine, and a single pipe conducts the exhaust steam from the cylinder to the condenser. The cylinders are cast with a square box around them, which is filled with steam from the boiler; but the upper part of the space between this box and the cylinders constitutes a passage for the exhaust steam, and is consequently separated from

Fig. 59.

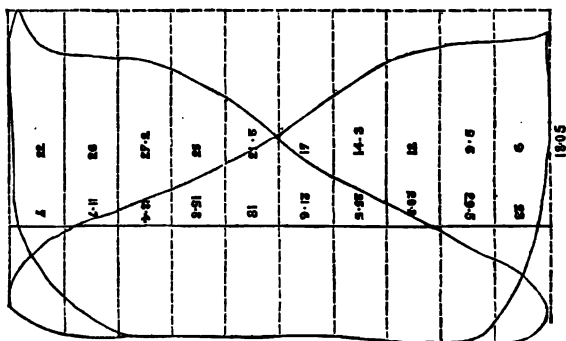

INDICATOR DIAGRAMS FROM ENGINES OF SCREW STEAM YACHT BRILLIANT, BY MESSRS. DAY & CO., SOUTHAMPTON.

the rest of the box by a proper partition. The box itself is lagged to prevent the dispersion of the heat. The condenser stands between the guides of the two engines, in which situation it is quite out of the way, and leaves the guides perfectly accessible. Messrs. Day & Co. very generally employ surface condensers, but they are so compact that their presence is scarcely known by any external sign; and by merely opening a communication valve they may at any time be converted almost instantly into common condensers. The

air pump of one engine acts as a circulating pump for the refrigerating water; and the water is sometimes drawn through the tubes and sometimes forced. The other air pump more than suffices to pump out the small quantity of water arising from the condensation of the steam; and the two air pumps are at any time available for their ordinary duties, should the condensation by jet be at any time resumed.

Messrs. Humphrys & Tennant. These makers generally employ double-cylinder engines, which in some cases, as in that of the Moulton, are vertical, and in other cases, like that of the Poonah, are horizontal. In the engines of the Moulton, the cylinders are inverted, and stand above the screw shaft; and the connecting rods, which are jointed to the ends of the piston rods as in locomotives, work down to the shaft. There are two large cylinders, and two small ones, the large cylinders being 96 in. diameter, and the small ones 43 in. The stroke of both is 3 ft. The two pistons are fixed on one rod, vertically over each other. The total heating surface in the boilers is about 12 sq. ft. per nominal horse power. The engines are fitted with Hall's surface condensers containing about the same surface as the boilers; and the cold water is caused to flow through them by a centrifugal pump on Appold's system, made by Easton & Amos. The boilers are also provided with Lamb's superheating apparatus, which contains about $3\frac{1}{2}$ sq. ft. of surface per nominal horse power. The engines of the Poonah are similar to the foregoing, only horizontal. In Messrs. Humphry's recent horizontal engines, the air pump, which is also horizontal, and is placed

beneath the condenser, is so constructed as to drain the condenser completely at every stroke; and the pump barrel is at all times filled with water, which being pressed by the air pump piston, displaces the water which last entered.

Messrs. Caird & Co. In their recent examples of screw engines, Messrs. Caird & Co. of Greenock have introduced surface condensers and other expedients to promote economy of fuel. The following are the principal particulars of the steamer *Hansa*, built to ply between Bremen and America:—The engines are direct acting, having inverted cylinders of 80 in. diameter, with a stroke of 3 ft. 6 in. The slide valves are double-ported, worked with a link motion, and having a variable grated expansion valve, placed immediately behind the main slide valve, worked by an eccentric and a shifting link, to vary the cut off from the cylinder as required. The crank shaft is 16 in. diameter at the bearings; the screw shafts are 14½ in. diameter; the propeller shaft bearings are covered with brass, and the stern pipe is bushed with brass. The surface condenser has 3,584 brass tubes, 1 in. external diameter, and 7 ft. long; the steam to be condensed surrounds the tubes, and cold water is passed through them at the rate of from 750 to 1,000 cubic ft. per minute, as may be necessary. The water is pumped from the sea by two horizontal double-acting pumps, worked from the forward end of the crank shaft. These pumps are 21 in. diameter, with a stroke of 24 in. The boilers are in four separate parts, having four furnaces in each part, with a total grate surface of 350 sq. ft., and a heating surface of

9,200 sq. ft. The superheating chest is placed immediately under the funnel, and has a total heating surface of 2,100 sq. ft. There are two safety valves to each boiler, loaded to 25 lbs. per sq. in. There is also an auxiliary boiler for keeping up the supply of fresh water that may be lost through blowing off steam, or from leaky joints. The grate surface of the auxiliary boiler is about 24 sq. ft., and the heating surface about 500 sq. ft. There is also a small boiler for working the deck winches; and a donkey engine for the steam of the boiler to work.

Rowan's Expansive Steam Engine. This species of engine combines the various improvements of a high pressure of steam with superheating and surface condensation; and is reported to have acted with a smaller consumption of fuel than has been heretofore attained in any engine whatever. In one case, an engine of this kind was reported by Professor Rankine as capable of working with a little over 1 lb. of coal per indicated horse power per hour; but this measure of economy does not appear to have been supported in practice. *Fig. 60* is a representation of Rowan's engines as applied to drive the screw propeller. There are two inverted engines combined as usual at right angles, to turn round the screw shaft. But each engine has three cylinders—the middle one, which is the smallest, being a high pressure one, and the two side ones being low pressure. The three piston rods are connected to a cross head, and move up and down simultaneously. The steam, after having acted on the piston of the high pressure cylinder, passes into the low pressure cylinders, from whence

Fig. 60.

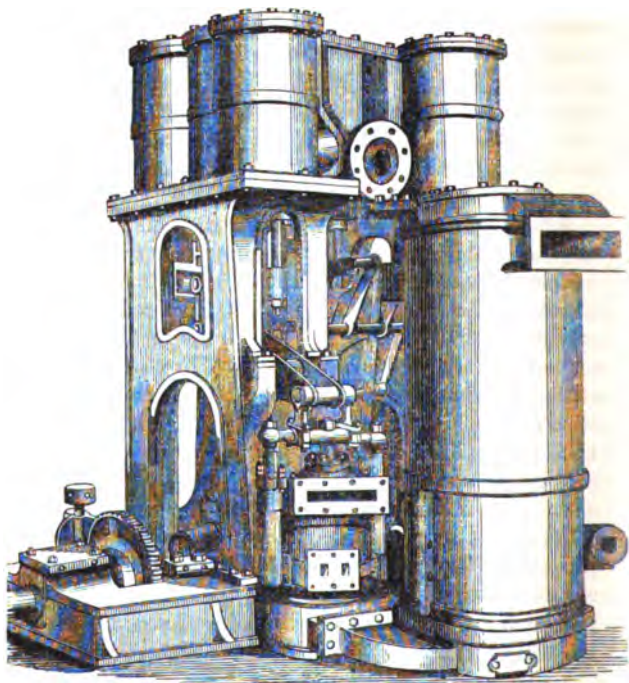

ROWAN'S TREBLE CYLINDER EXPANSIVE ENGINE.

it passes into a tall cylindrical vessel, traversed by small vertical tubes, and filled with cold water. The water surrounds the tubes; and through them the steam passes and is condensed and returned to the boiler as hot distilled water. An agitator is kept revolving within the cylindrical vessel to insure the cold water being equally distributed among all the tubes, and one of the air pumps is fitted up to maintain a circulation of water through the condenser, while the other is fitted to act as an air pump in the usual manner. About 10 or 11 sq. ft. of condenser surface per nominal horse-power is the proportion given in Rowan's engines.

Messrs. Simpson & Co. Messrs. Simpson & Co. of London have lately introduced a species of double cylinder engine in which the high-pressure cylinder is placed within the low-pressure cylinder; the latter being in fact an annular cylinder, with a cylinder of smaller diameter within it. The steam is admitted and discharged from both cylinders by means of a single valve; and the arrangements appear on the whole to be such as will commend themselves to public approbation.

Millwall Iron Company. The direct acting engines constructed by the Millwall Iron Company for the West India Mail Company's screw steamer Rhone have two inverted cylinders working down to the screw shaft; and the engines are fitted with surface condensers, the pumps for maintaining a circulation through which are placed in a horizontal position at the end of the engines, and are worked off a crank on the end of the screw shaft. The intermediate

shaft is formed of Krupp's steel; and the workmanship and materials of the engines are of the very first quality. A drawing of these engines is given in *fig. 61*.

In another set of engines by the same makers, there are three inverted cylinders working down to the screw shaft, and the cylinders have steam jackets and other economical arrangements which are expected to reduce the consumption to a little over 2 lbs. of coal per actual horse-power per hour.

Messrs. R. & W. Hawthorn. The marine engines of these makers have long enjoyed a very high reputation for efficiency and durability, and for a most remarkable exemption from accidental derangements or break-downs. Their screw engines are of the horizontal kind, with the condensers opposite to the cylinders; and long eduction pipes communicating from the one to the other as in Messrs. Penn's arrangement. But instead of the trunk, a short connecting rod joined to the piston rod is used after the fashion employed in locomotives. In the engines of H. M. screw gunboat *Shearwater*, constructed by Messrs. Hawthorn, the cylinders are 40 in. diameter, and the stroke 22 in. The nominal power is 150 horses, and the pressure of steam in the boiler is 20 lbs. per sq. in. There are two boilers of the ordinary gunboat construction, with three furnaces in each; and 297 brass tubes running at right angles to the furnaces, and containing a total heating surface of 2,892 sq. ft. or 19·2 sq. ft. per nominal horse-power. The *Shearwater* is a vessel of 669 tons; and with a displacement of 840 tons, and an area of midship section of 278 sq. ft., she realised a speed of

Fig. 01.

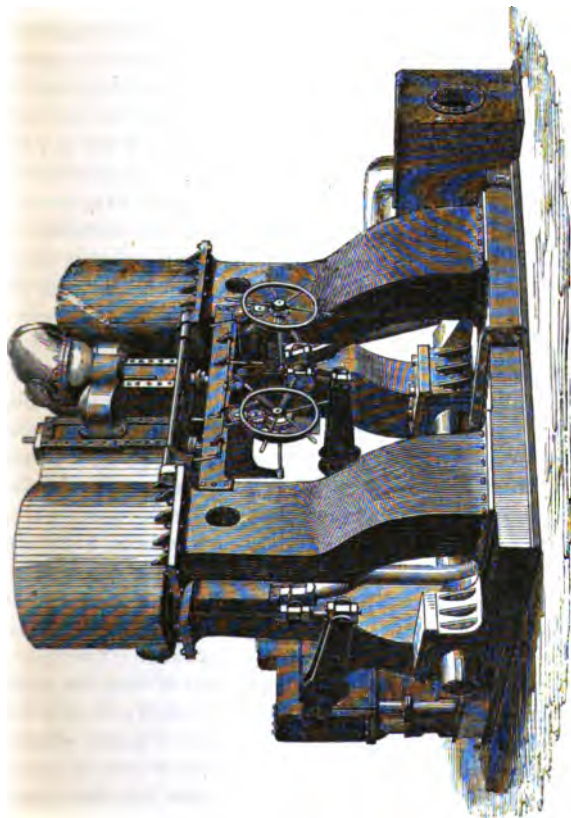

ENGINES OF THE STEAMER RHONE BY THE MILLWALL IRON COMPANY.

9 knots, the engines making 92 revolutions per minute, and exerting 632 actual horse-power. The screw propeller is one of Griffiths' of 10 ft. diameter.

Here, then, I close my remarks on marine engines of recent construction ; and notwithstanding the innumerable and incessant efforts which have been made to introduce new improvements, I do not see that any considerable improvement has yet been introduced. Superheating, from which such exaggerated benefits were at one time expected, has collapsed to its proper dimensions ; and it is now found that about the same amount of superheating as obtained in the old flue boilers is the most beneficial. The pressure has been gradually increasing, and that no doubt is a benefit if adequate measures be simultaneously adopted to increase the strength of the boiler. But the existing marine boiler is ill adapted to withstand any considerable pressure ; and, as things now stand, to increase the pressure is to increase the risks of explosion. The method of surface condensation now so generally employed in steam vessels I do not believe will be permanently retained, at least in its present cumbrous form ; and on the whole there is very little that is new in marine engines which can be characterised as a permanent amelioration. The introduction of the governor and the use of steel for shafts are valid steps of improvement, though not very momentous ones ; and, indeed, the use of a steel shaft is only tantamount to the employment of an iron one so much larger than before. We now require marine boilers capable of enduring high pressures of steam with safety, and if salt water is used in the boilers,

we require the introduction of some arrangement which will prevent the sulphate of lime from being precipitated on the heating surfaces, which takes place at a temperature answering to 40 lbs. pressure of steam without any concentration of the water at all. We also require the introduction of some simple and effectual mechanism for firing the furnaces, especially in the case of large vessels employed in warm climates. It would also be an advantage, especially in the case of vessels performing long voyages, if some really effectual and unobjectionable method could be introduced of burning the smoke.

LOCOMOTIVE ENGINES.

There are two main objects of aspiration which are set forth in the designs of many of the modern locomotives; the one to burn the smoke so as to enable coal instead of coke to be either wholly or partly used in the furnace; the other to realise great tractive power, so as to enable each goods engine to draw heavier trains than heretofore. Neither of these indications can be said to have been very perfectly fulfilled by any of the plans hitherto propounded for that purpose; and in seeking to increase the power, various forms of monstrosity have been produced, promising neither eminent success nor great longevity. In particular, the recent goods engines on some of the continental railways are remarkable examples of retrograde improvement; and it does not appear probable that the use of such cumbrous and gouty structures can long be retained

after the stimulus of novelty attending their creation has passed away.

The various plans which have been propounded for burning smoke in locomotives are mostly reproductions of old plans long since tried in land and marine engines, and gradually abandoned. The principle on which these various arrangements are founded is either that of admitting air above the fuel, to burn the smoke, or that of using a sufficient area of fire bars, and a sufficiently thin fire, to enable the quantity of air required to burn the smoke to pass through the fire; and the smoke is conducted either among hot bricks and tiles, or over incandescent embers, to induce the more effectual union of the uncombined oxygen in the air with the unconsumed carbon in the smoke. All these methods, however, are only methods of approximation, which though they diminish the smoke by no means prevent it; and the consequence is, that locomotives pretending to burn the smoke, or unlawfully using coal even without this plea, are now spreading such large volumes of smoke over the face of the country as to constitute a new and serious nuisance. Heretofore coke only was used in locomotives, when of course no smoke was created. But, of late years, they have been gradually sliding into the use of coal; and the probability is, that the nuisance will go on increasing until it becomes intolerable, and is finally subverted by the strong hand of power. Some of the smoke-burning expedients employed are merely hollow pretexts for the evasion of the obvious duty of burning the smoke.

COAL-BURNING LOCOMOTIVES.

It would be impossible to enumerate within the limits to which these remarks have to be restricted, the numerous projects which have been propounded at different times for burning the smoke in steam boilers. Among those who have directed their attention to burning smoke in locomotives, the plans of Gray, Dewrance, Yarrow, M'Connell, Beattie, Cudworth, and Tembrinck, and especially the four last, have attracted most attention, and some of these expedients have obtained a pretty wide introduction. In M'Connell's arrangement the fire-box is divided longitudinally by a water space, so as in reality to form two furnaces like the furnaces of a marine boiler. Air is admitted at sundry openings at the front and sides of the fire-box, and the tubes are considerably shortened in the barrel of the boiler, so as to leave room for a combustion chamber in which the smoke may rest and be burned. In some of the forms of Beattie's boiler, a similar combustion chamber is employed, and an excellent and recent example of his engine is given in *fig. 62*, which is a representation of the express passenger engine Lacy, placed upon the London and South-Western Railway in 1864. In this engine the diameter of cylinder is 17 in.; stroke, 22 in.; working pressure, 135 lbs. per sq. in.; diameter of barrel of boiler, 4 ft.; length of barrel, 9 ft. 6 in.; length of fire-box, 4 ft. 6 in.; width of fire-box, 4 ft.; heating surface of fire-box and chamber, 178.36 sq. ft.; heating surface of hollow stays, 32.63 sq. ft.; heating surface of tubes,

Fig. 12.

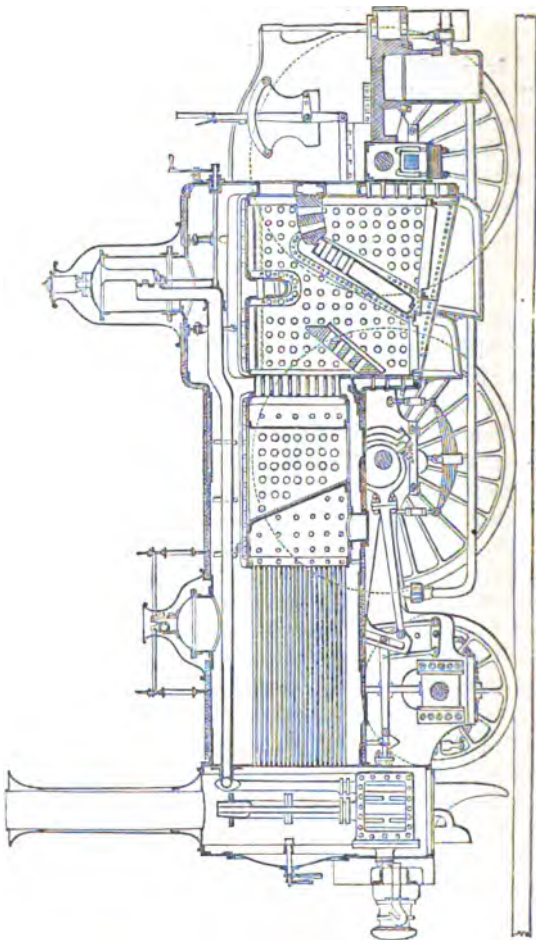

BEATTIE'S COAL-BURNING EXPRESS ENGINE LACY.

598·31 sq. ft.; total heating surface, 809·3 sq. ft. The driving and trailing wheels are coupled, and are 7 ft. in diameter; the leading wheels are 4 ft. in diameter. The distance between the driving and leading wheels is 6 ft. 2½ in., and between the driving and trailing wheels, 8 ft., making the total length of the wheel base 14 ft. 2½ in. The total weight of this engine is about 32 tons, distributed as follows: on the driving wheels 12 tons; on the leading wheels, 11 tons; and on the trailing wheels, 9 tons. There are 18 of these engines already made, and others in course of construction. The average consumption of fuel in these engines is 24 lbs. per mile, the average load being 15·5 carriages, and sometimes 30 carriages are taken. The average speed maintained with these engines is for express trains, 45 to 50 miles an hour, and for ordinary trains, 30 to 40 miles an hour. The piston rods, connecting rods, coupling rods, cross heads, wheel tires, and other main parts are of Bessemer's steel; and Allan's straight link is used for transmitting the motion to the valve.

The smoke is burned by dividing the furnace into two furnaces by the inclined water bridge running from side to side of the fire-box, which bridge is perforated; and the space between it and the furnace door is covered by a perforated fire block, thus forming an inclosed furnace, the smoke from which must escape through the perforations. This furnace is fitted with a door of its own below the ordinary fire door, which is placed higher than usual; and the furnace next the tubes may be fed with coke, while the other is fed with coal. The smoke escaping

through the perforations is deflected by the hanging bridge down towards the incandescent coke, and is consequently in a great measure consumed; and the products of combustion pass through a number of short pipes into the combustion chamber, and from thence into the tubes. These engines are also fitted with Mr. Beattie's feed-water heater, which employs a portion of the exhaust steam to heat the feed-water boiling hot. In consequence of this arrangement, Mr. Beattie is precluded from using Giffard's injector; and the boiler is fed by pumps in the usual manner, which seems, all things considered, to be the preferable arrangement.

The peculiar feature of Cudworth's engine, represented in *fig. 63*, is the fire-box. This is made very long, and is carried back over the hind axle; the fire-grate is inclined towards the tube-plate, and at the lower end it is furnished with a trap-door through which the clinkers and ashes are discharged, and the fire is dropped. The fire-door is perforated; and air is admitted through it when necessary.

A thin fire is kept on the grate. The fresh fuel is supplied at the upper end only, and it gradually descends during combustion, so that there is only a bright clear fire at the lower end. The gases evolved from the fresh fuel mixed with air passing through the grate and door, are sufficiently heated in their way to the tubes to inflame, and hence less smoke is made. It is one of the advantages of this engine that owing to the fire-box projecting over the hind axle the weight on the coupled wheels is increased

Fig. 63.

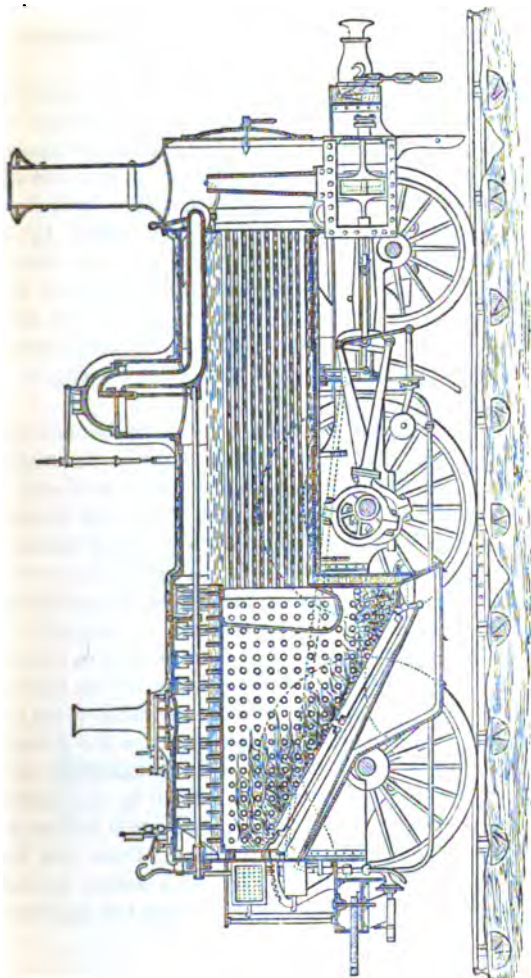

CUDWORTH'S COAL-BURNING LOCOMOTIVE. SOUTH EASTERN RAILWAY.

and equalised. In fact the weight of the engine is equally distributed over all the wheels.

Sharp, Stewart & Co.'s smoke-burning locomotive, which is represented in *fig. 64*, is very similar to Cudworth's. This engine has been specially designed for working a heavy goods traffic on a line having sharp curves and steep gradients. The principal dimensions are as follows: inside cylinders, 19 in. diameter, and 24 in. stroke; there are six wheels coupled, of 4 ft. 4 in. diameter: the weight on the leading axle is 12 tons 17 cwt., on the centre axle 13 tons 19 cwt., and on the hind axle 11 tons 13 cwt.; making a total weight of 38 tons when the engine is in running condition.

The form of coal-burning locomotive furnace employed on many of the French railways is represented in *fig. 65*, which shows the fire-box of one of the locomotives employed on the Paris and Orleans railway, and in which Tembrinck's system of burning the smoke is introduced. A is the fire-box in which the fire is placed, resting on the fire bars B, and these bars are made taper, so as to have a narrower air space near the furnace mouth than further in; C is a set of subsidiary bars set in a frame which may be opened to drop the fire, or to let the clinker out; D is a water space running obliquely across the furnace nearly parallel to the bars; E is a mouthpiece to receive the coal which is there roasted by the radiant heat from the fire; and the expelled gas is burned by coming into contact with the flame from the fire after being mixed with the air which enters through the air-valve at F, which is regulated by the handle G;

Fig. 64

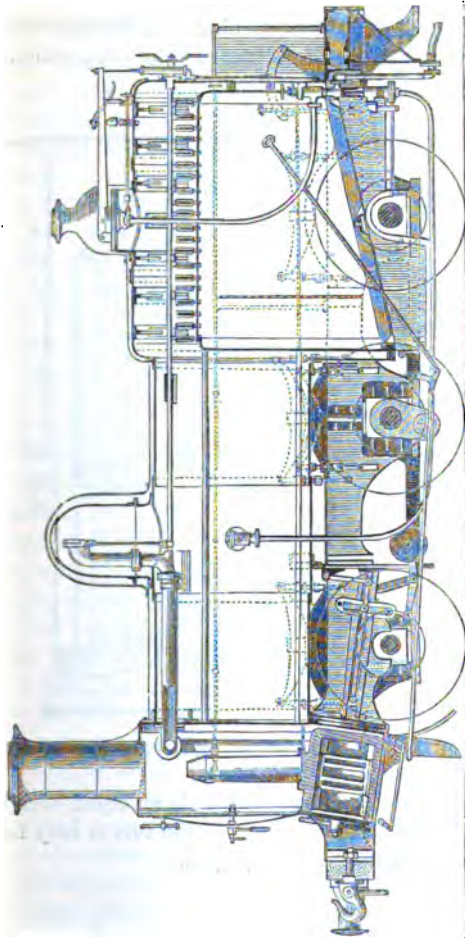

SHARP, STEWART AND CO.'S COAL-BURNING LOCOMOTIVE.

H is one of the doors opening into the fire-box. It is stated that in these engines the evaporation with

Fig. 65.

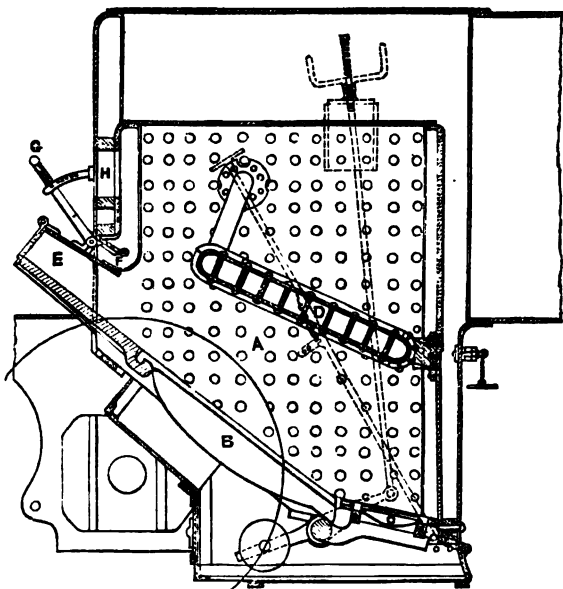

FIRE-BOX ON TEMBRINCK'S SYSTEM.

coal is about the same as with an equal weight of coke, and that the expense of the fuel is only half as great as when coke is employed.

FOREIGN GOODS LOCOMOTIVES.

Some idea will be formed of the kind of 'steam elephants' employed on some of the foreign railways in conveying goods, by a reference to *figs.* 66, 67, and 68, and which are a side elevation and two transverse sections of one of the 8-wheeled goods engines employed on the Northern Railway of France. It will be observed the fire-box is considerably wider than the width between the wheels; and the barrel of the boiler is crammed so full of tubes as to leave scarcely any room for steam, and little facility for the circulation of the water. Of course such a boiler will prime; but to meet this difficulty a superheater is carried along the top of the boiler: and as with all this gear the erection would be too high to go under the bridges with the addition of the chimney, a horizontal chimney a little turned up at the end is employed. Machines however even still more formidable than this are used in some cases; and on the same line engines with twelve coupled wheels and four cylinders are employed, two of the cylinders being placed at one end of the engine and driving six of the wheels, and the other two cylinders being placed at the other end of the engine and driving the other six wheels. So far as these parts are concerned, there are virtually two locomotives; but there is only one boiler resting on one framing, in which all the wheels are placed. To enable such a great length of coupled wheels, however, to get round curves the fore and after axles of each group of six wheels is susceptible of a little end play; and a horizontal lever with a fulcrum over the centre axle of each group extends to the fore and after axle of each group, to which it is so connected that when

Fig. 66.

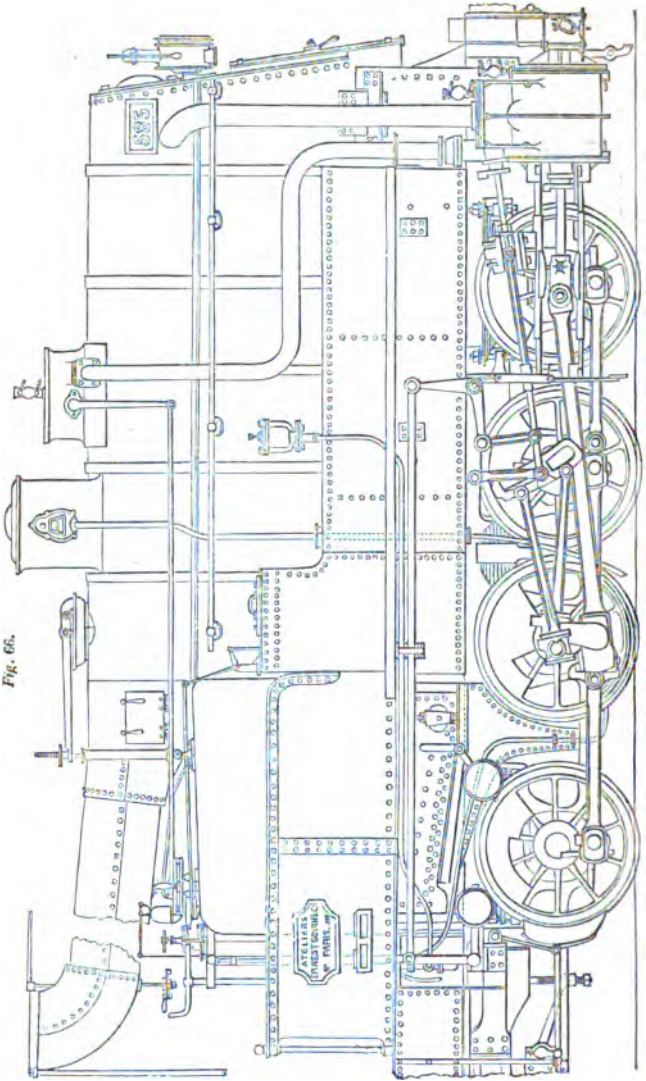

EIGHT-WHEELED GOODS ENGINE, NORTHERN RAILWAY OF FRANCE.

the fore axle moves a little on end in one direction, the after axle shall be constrained to move a little on end in the opposite direction. By this complex ar-

Fig. 67.

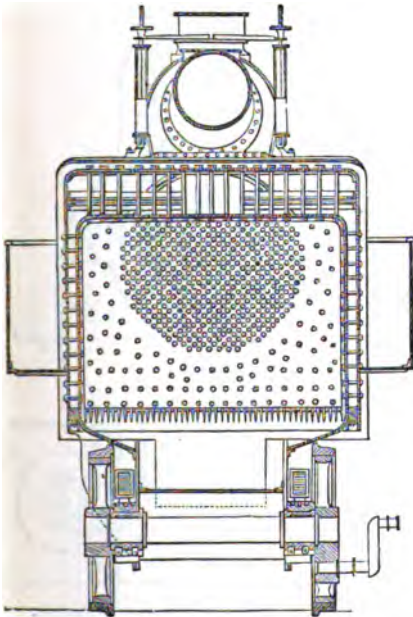

GOODS ENGINE NORTHERN RAILWAY OF FRANCE.
Cross Section through Fire-box.

rangement the one group of six wheels is enabled so to arrange itself relatively with the other group that an effect tantamount to that produced by a joint in the

frame is obtained. The peculiar features of this engine will be better understood by a reference to *fig.*

Fig. 68.

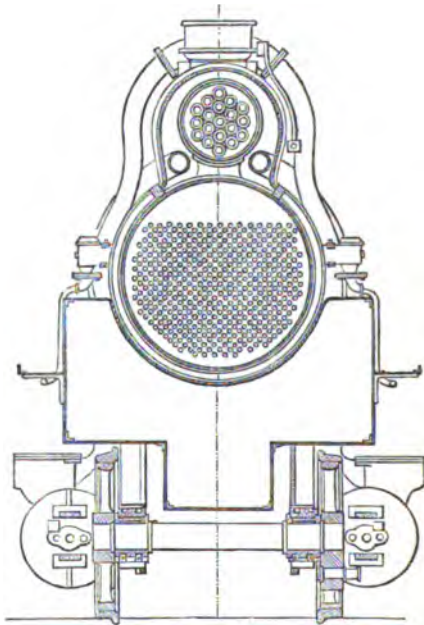

GOODS ENGINE, NORTHERN RAILWAY OF FRANCE.
Cross Section through Smoke-box.

69, where $\Delta \Delta$ are the cylinders, B the boiler, s the superheater, and C the chimney.

One of the engines of the Orleans railway is represented in *fig. 70*, but as it resembles the construction

Fig. 60.

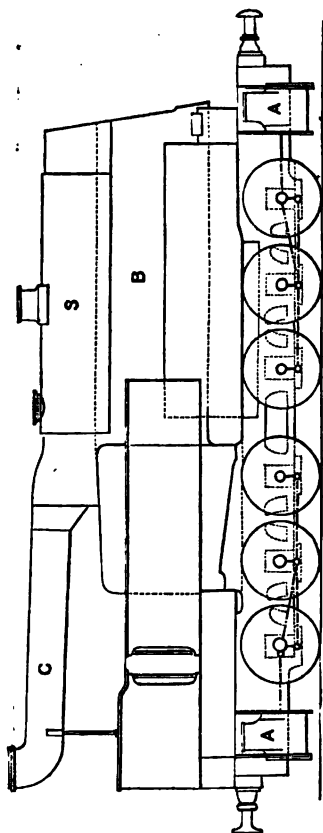

FOUR-CYLINDER LOCOMOTIVE WITH SIX DRIVEN AXLES, NORTHERN RAILWAY OF FRANCE.

of common locomotives, it is unnecessary to describe it.

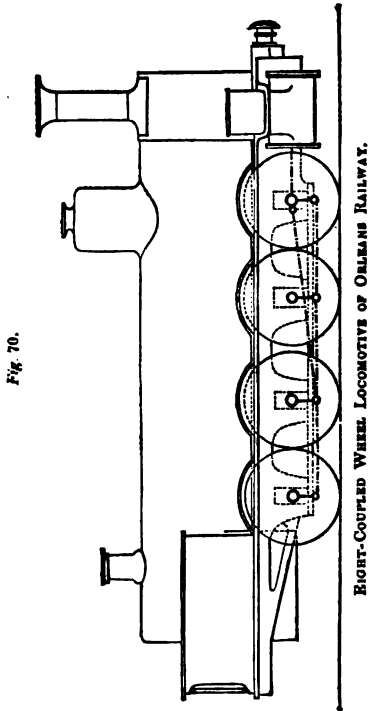

One of the steepest gradients which has to be surmounted by railways in any situation is that known as the Scemmering incline, on the line from Vienna to Trieste, where it crosses the Styrian Alps. Various

Fig. 71.

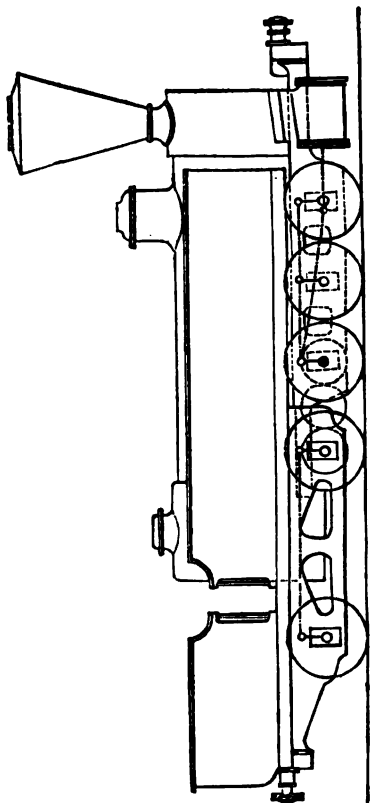

TEN-COUPLED WHEEL LOCOMOTIVE OF SCHEMMING INCLINE, 1856.

special forms of locomotives have been contrived to surmount this difficulty, in some of which the wheels of the tender were driven from the engine by pitched chains, and in other cases spur wheels between the axles are employed. *Fig. 71* represents the form of engine employed on this service in 1856, and *fig. 72* represents the form employed in 1861. In this last example the tender is attached to the engine in the

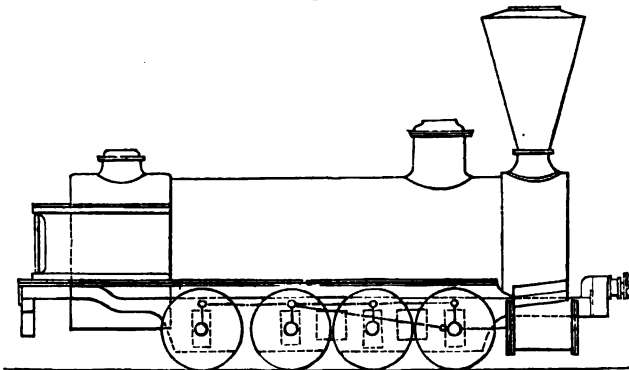
Fig. 72.

EIGHT-COUPLED WHEEL ENGINE OF SCHEMMEING INCLINE, 1861.

manner usual upon other railways ; but in *fig. 71* the tender is stuck on to the end of the engine and is supported upon wheels which are put into revolution by means of rods proceeding from the nearest wheels of the engine, which wheels are themselves put into revolution by means of gearing. Upon the third axle of the engine a toothed wheel is fixed, which gears into another toothed wheel of the same size,

and this last wheel gears into another toothed wheel on the next axle and turns it round. The positions of these toothed wheels are shown in the figure by dotted circles.

In some of the forms of engine with four cylinders, and six coupled axles, three of the axles and two of the cylinders are attached to a framing, on which the boiler rests on two points, one on each side of the fire box, while the other three axles and the other two cylinders are attached to a bogie or independent carriage travelling upon a centre on which the smoke box rests, and this bogie accommodates itself to the curves of the road. Such a device however is only a clumsy approximation to two independent engines, and the use of two engines with the footplates brought together as recommended by me in my 'Treatise on the Steam Engine' in 1845, so that one set of handles might govern the movements of both engines and one stoker fire both furnaces, would be greatly preferable to the use of those uncouth leviathans. The great height of these engines relatively with the width of base necessarily makes them top heavy; while the relative narrowness of the gauge—which limits the diameter of the barrel of the boiler and consequently the area for the introduction of the tubes—has led to such crowding and such contraction of the areas in this part, as to diminish the efficiency of the heating surface, besides leading to other inconveniences.

The principal dimensions of some of the more remarkable of the continental locomotives are given in the following table :—

PARTICULARS OF FOREIGN			
Line on which the Engine runs . . .	Northern of France		
Kind of Engine	Engerth 4 coupled axles.	4 coupled axles.	4 cylinders 6 driven axles.
Diameter of cylinder in inches . . .	19.68	18.89	17.32
Length of stroke in inches	25.98	18.89	17.32
Diameter of driving wheel in inches . . .	49.60	62.99	41.73
Pressure of steam in lbs. per square inch	120	135	135
Heating surface of fire box in square feet	115.71	107.64	107.64
Heating surface of tubes in square feet	2004.55	1687.76	2371.17
Total heating surface in square feet	3120.26	1795.40*	2378.81†
Weight of engine in tons when at work	88	99	131.34
Weight of tender in tons laden	50.16	—	—
Total weight in tons of engine and tender at work	138.16	99	131.34
Weight producing adhesion in tons	88	99	131.34
Greatest load drawn in tons	655	436	655
Speed regularly maintained in miles per hour in ascending incline	12.4	12.4	12.4

* To this has to be added heating surface of superheater 130 square feet.

AMERICAN LOCOMOTIVES.

The American locomotives differ in several of their features from those which are employed in this country, and there is nearly always some special feature in the traffic, the fuel or the climate to warrant the distinction, and to render it judicious; but the difference is not nearly so great as that which obtains in some of the continental locomotives. The fore part of the engine is usually supported upon a small four-wheeled truck or bogie; a large cone is placed around the chimney for catching the sparks, which are very

GOODS LOCOMOTIVES.

Orleans.	Lyon.	Eastern of France.	Western of France.	Sommering.	Turin.
4 coupled axles, separate tender.	3 coupled axles, separate tender.	Engerth 4 coupled axles, separate tender.	3 coupled axles, separate tender.	Engerth geared 5 coupled axles.	Double and 6 coupled axles.
19-68	17-71	19-68	17-32	18-70	15-98
25-69	25-59	25-98	23-62	24-01	21-96
45-66	51-18	49-60	55-11	41-92	48-03
120	120	120	120-125	145-25	117
114-50	89-34	104-49	86-11	75-35	157-15
211-08	1945-08	2022-09	1442-35	1671-51	2006-23
228-26	1334-42	2126-58	1528-46	1648-86	2163-62
9-24	81-4	99	72-6	91-52	145-2
40-04	44	52-8	44	57-2	
137-28	123-4	151-8	116-6	148-72	145-2
97-24	81-4	99	72-6	148-72	145-2
254	122	600	300	250	120
9-3	9-3	12-4	15-5	9-3	9-30

† To this has to be added heating surface of superheater 239 square feet.

inconvenient when wood is burned. A sort of inverted saucer over the mouth of the chimney deflects the sparks downwards into this cone, whence they are drawn off at intervals by a small door. The top of the cone is covered with wire gauze, to intercept any sparks which escape being driven out of the cone. In the front of the engine is an arrangement of bars of iron called a cowcatcher, for throwing any object off the line which may happen to be upon it; and this apparatus also acts like a snow plough, should snow have fallen on the line. *Fig. 73* is a side elevation of a common form of American locomotive; **A** is a shed

Fig. 73.

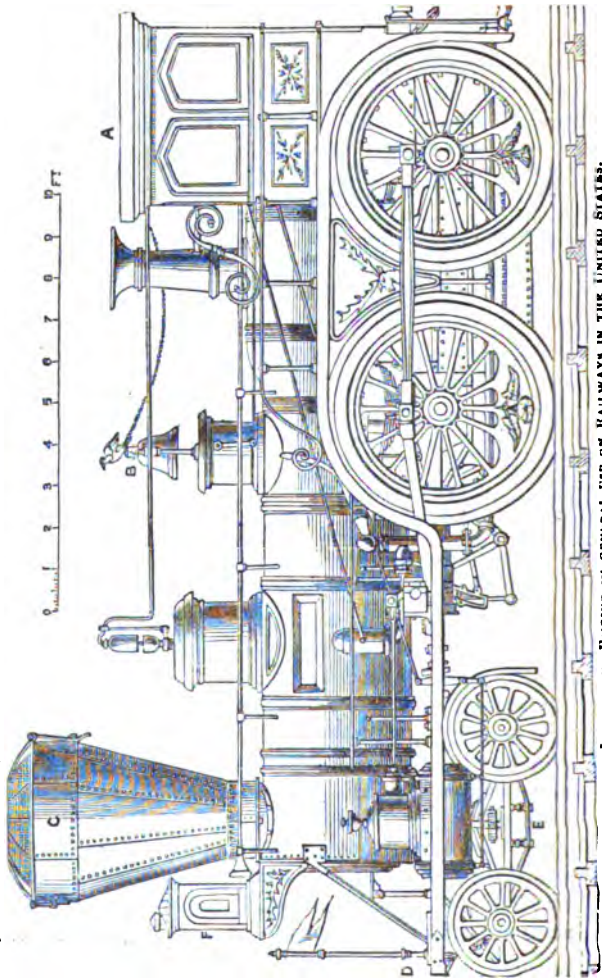

ELEVATION OF LOCOMOTIVE ENGINE IN GENERAL USE ON RAILWAYS IN THE UNITED STATES.

or covering for protecting the engine driver from the weather ; B is a bell which is rung when the engine approaches stations ; C is an inverted cone round the chimney to catch sparks from the furnace ; D, situation of cowcatcher ; E is the truck or bogie by which the fore part of the engine is supported ; and F is a lamp to give light by night. The driving wheels are generally four in number, coupled together ; they are commonly from 5 ft. to 5 ft. 6 in. diameter, or when great speed is required, they are 6 ft., and sometimes 7 ft. in diameter ; but it is almost the invariable custom to use four coupled wheels for all speeds. The coupled wheels are placed about 18 in. asunder ; the hind pair is furnished with flanges, but the leading driving wheels are usually without flanges, and are commonly cylindrical, instead of being somewhat coned. The cylindrical wheels are said to wear much better than the coned, and to cause less oscillation. For working steep inclines, engines with eight wheels coupled, and from 2 ft. 6 in. to 2 ft. 9 in. diameter, are usually employed. These wheels are generally of chilled cast iron. It is usual to make the driving wheels of passenger engines with cast-iron centres and wrought-iron tires, but sometimes the tires are of chilled cast iron, which is said to be better fitted to endure the frost. In the heavy engines employed in transporting coal on the Reading Railway, and which burn anthracite coal, there are eight coupled wheels of 43 in. diameter, and the cylinders are 19 in. diameter, and 22 in. stroke ; the boiler is 46 in. diameter, and contains 103 iron tubes, 2½ in. external diameter and 14 ft. long ; the furnace is 7 ft. long, and the bars are cast

in pairs, and are made moveable by a lever, so that the clinker may be readily broken up. The ash pan is made to contain a few inches of water, to prevent the bars from being burnt out. A good deal of the coal is said to be wasted in these engines, from being carried up the chimney by the draught; and a good deal by falling through the bars of the grate. Upon the whole, anthracite coal cannot be said to have been very successfully introduced in locomotives. It is severe upon the furnace, and the evaporating efficacy reached does not appear to have been more than 7 lbs. of water per pound of coal, which is a good deal less than is obtained with coke.

There are generally no buffers between the engine and tender of American locomotives, but a wedge is interposed between the abutting surfaces to prevent shocks. In the various carriages of the train, central buffers alone are used. The whistle is larger than that used on the English lines. Glass gauges are not found to stand, and four or five gauge-cocks are employed instead. The feed pumps have air vessels both on the drawing and the forcing sides. The link motion is in universal use. The axle boxes are usually made close, and are supplied with oil, and provided with leather washers to keep the oil in. The boxes do not require to be packed or oiled more than once a month. The boxes are sometimes of bell-metal, sometimes of a composition of $92\frac{1}{2}$ parts of zinc and $7\frac{1}{2}$ parts of copper, and sometimes are lined with, or wholly composed of, soft metal.

To give toughness to the cast iron wheels, they require, after having been cast in a chill, to be annealed.

The wheels, therefore, as soon as they are set, and while yet red hot, are transferred to pits which have been made very hot by anthracite fires. The pits are hermetically sealed, to prevent the admission of air; and after three days the wheels are taken out, when the annealing process is found to be completed. The annealing does not affect the chilling of the tire, which is half an inch deep, as the operation of chilling takes place when the metal sets. It is necessary, however, with these chilled wheels to be careful not to apply the breaks too suddenly, so as to occasion slipping on the rails, as the friction takes out the chill at that spot and causes a flat soft place to form on the wheel, which destroys it altogether. Brake blocks of cast iron are used in some cases, and are found to be preferable to wood. The brakes are set by winding a chain in connection with them on an upright barrel having a handwheel at the top. In cases of emergency it has been proposed to work the brakes by a friction wheel which may be instantly pressed down on the driving wheel of the engine. A cord is carried along the top of every carriage of the train to a large gong bell placed on the engine. This cord is formed in lengths equal to the length of a carriage, and the pieces are connected together by metal snaps. A small shaft led along the top of each carriage with square or triangular ends and sockets and universal joints would be an equally simple arrangement. It is not found practically in America that there is any trouble in connecting the cord to the new carriages when a change in the carriages takes place.

The American railway carriages are of much larger

dimensions than those employed in this country. The bodies are commonly made about 45 ft. long, $9\frac{1}{2}$ ft. wide, and 7 ft. high. The carriages are open from end to end, and at the end doors are placed, opening upon platforms protected by railings, and establishing a passage between one carriage and the next adjoining. From the platform stairs descend, by means of which passengers enter or leave the carriages. The seats are ranged on each side of a central passage; and the backs of the seats are made to turn either way. On the roof of the carriages ventilators are placed; and there is a stove to warm the carriage in winter, and a supply of drinking water. To prevent the dust from arising, a canvas curtain has been introduced outside the wheels on some lines, extending from the carriage floor to the ground, whereby the dust is prevented from being sucked up by the motion of the train. In other cases jets of water propelled by a centrifugal pump, moved by a friction roller resting on one of the wheels, have been introduced in an air space on each side of the carriage, through which the air is admitted; and the air is thus cooled and freed from dust by the same operation.

The carriage rests at each end on a truck or bogie, the wheels of which are as far apart as the distance between the rails, so that the plan of such a truck forms a square. India rubber springs have been tried, but the result has not been satisfactory; and plate or volute springs are now usually employed.

In all the American locomotives, the internal fire box is considerably smaller at the top than at the bottom, so that the sides are much inclined, whereby

the escape of the steam from the surface of the metal is facilitated, and the overheating of the plate prevented. The fire boxes are almost universally of iron. The tubes of the boiler are generally of copper—few iron or brass tubes being in use, except that in engines using anthracite coal, iron tubes are used to diminish the wear caused by the hard particles of coal carried up by the draught, and which copper cannot so well withstand. The general proportions of the American locomotives do not differ materially from those prevailing in England. On the whole, however, the blast pipes require to be smaller, and the draught more intense for engines burning wood, to maintain sufficient vividness of combustion; and the disposition now is to place the tubes farther apart than formerly, as has been long found in this country to be expedient. In some engines it has been found that an increased supply of steam was obtained by removing some of the central tubes; and the tubes are never placed closer than $\frac{3}{4}$ of an inch apart.

There is a separate blast pipe from each cylinder; and these pipes terminated at about the level of the lowest row of tubes. Suspended over these pipes, however, is a pipe entitled a 'petticoat pipe,' about 8 in. in diameter, which reaches nearly to the base of the chimney; and this pipe being generally made conical, has a petticoat configuration. The object of this arrangement is to equalise the draught through the different rows of tubes, as when the blast pipe is carried up to the level of the top row of tubes, the greatest draught will be through them.

STANDARD FORMS OF ENGLISH LOCOMOTIVES—BROAD GAUGE ENGINES.

The most powerful class of engines constructed for the broad gauge is that of the Great Britain and Iron Duke, of which the main particulars are given at page 84 of my 'Catechism of the Steam Engine,' and of which a cross section is given in *fig. 74*. In this engine, the cylinders are 18 in. diameter and 24 in. stroke. The grate contains 21 sq. ft. of area, and there are 305 tubes of 2 in. diameter in the boiler. The total heating surface is 1,952 sq. ft., and a cubic foot of water may be evaporated in the hour by every 5 sq. ft. of heating surface. An engine of this class will exert 750 actual horse-power. The pressure in the boiler is 100 lbs. per sq. in., and the initial pressure in the cylinder is about 10 lbs. less. But at high speeds the pressure in the valve box is greater than that in the boiler, which may be imputed to the momentum of the steam when its continuous flow is arrested by the shutting of the slide valve. At 60 miles an hour, when the handle which moves the link was in the first notch, and the steam cut off at $\frac{1}{4}$ of the stroke, the back pressure, when the area of the blast orifice was $\frac{1}{8}$ of the area of the piston, was 36 per cent. of the total pressure; and when the area of the blast orifice was enlarged to $\frac{1}{107}$ of the area of the cylinder, the back pressure fell to 10 per cent.

The pressure upon the slide valve of the Iron Duke

Fig. 74.

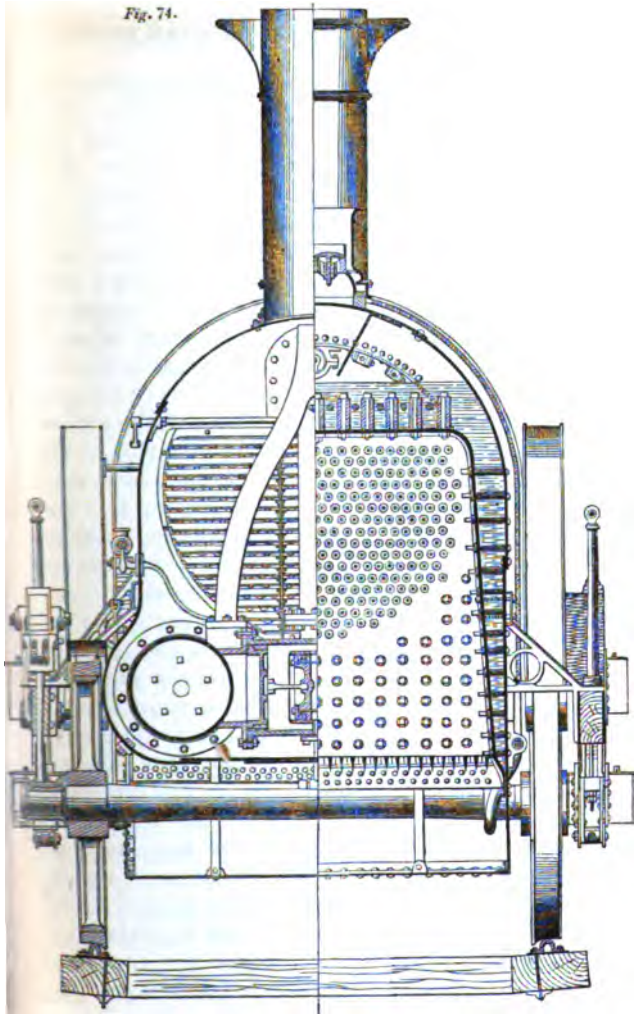

CROSS SECTION OF LOCOMOTIVE IRON DURE, GREAT WESTERN RAILWAY.
M

was relieved by means of a balance piston connected with the back of the valve by means of a link. But in locomotives this method of construction has not yet been carried out in a satisfactory manner. For moderately-sized engines it is perhaps hardly required, and a gridiron slide, which reduces the travel of the valve and correspondingly increases the leverage available for working it, is probably a preferable expedient in most cases. The benefit of taking off the pressure with a piston, instead of with a ring applied at the back of the valve as in marine engines, is that the valve is enabled to leave the face and let the water out of the cylinder if the engine should prime. But in the Iron Duke the pins at the ends of the link connecting the valve and piston were too small; and in all engines employing this expedient these pins should be very large so as to have adequate surface, and proper arrangements should also be introduced for their lubrication. To this end a close grease cup should be applied to the valve box with a side pipe to permit the steam to enter above the oil, so that the oil might gradually drip through the cock; and a suitable groove or shoot should be formed on the valve and piston to receive the drip of oil and conduct it to the joints in whatever position the valve may be when the drop falls. The communication pipe between the top of the piston and the blast pipe should be large, so as to equalise the pressure between the steam in the exhaust passage and that on the top of the piston, else the valve will leave the face when the exhaustion takes place.

The steam is drawn from the boiler through a per-

forated steam pipe, and its admission to the cylinders is regulated by a gridiron slide set in the smoke box, and worked by a rod extending through the perforated steam pipe to the front of the boiler. The damper consists of an arrangement of iron venetians set against the ends of the tubes in the smoke box, each of which acts as a hanging-bridge in retaining the hottest smoke in contact with the tubes. These venetians are lifted or lowered by an appropriate handle, and the draught is thus regulated. The width between the rails on which the wheels of this engine run is 7 ft.

Narrow Gauge Engines—London and North-Western Railway. The type of express passenger engine employed on the London and North-Western Railway, and constructed at the Crewe Works, is represented in *fig. 75*, and the following are the principal dimensions of that engine:—Diameter of cylinder, 16 in.; stroke, 24 in.; driving wheels, 7 ft. 6 in. diameter; leading and trailing wheels, 3 ft. 6 in. diameter; weight on leading wheels, 9 tons 8 cwt.; weight on trailing wheels, 6 tons 2 cwt.; weight on driving wheels, 10 tons 10 cwt.—total weight, 27 tons; heating surface of fire box, 85 sq. ft.; heating surface of 192 tubes, 1 $\frac{7}{8}$ in. external diameter and 10 ft. 9 in. long, 915 sq. ft. (internal); total heating surface, 1000 sq. ft.

The distance of the leading from the driving wheels is 7 ft. 7 in., and the distance of the trailing from the driving wheels is 7 ft. 10 in.—making the length of the wheel base 15 ft. 5 in. The tender carries 2 tons of coal and 1,500 gallons of water, and

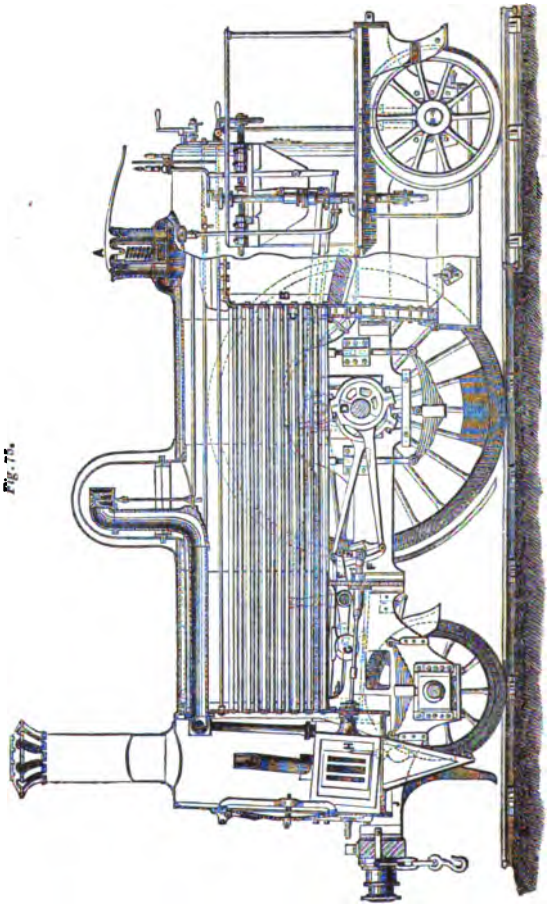

Fig. 75.

EXPRESS PASSENGER ENGINE, LONDON AND NORTH WESTERN RAILWAY, 1865.

its weight laden is 17 tons $8\frac{1}{2}$ cwt. It runs on six wheels of 3 ft. 6 in. diameter.

This form of express engine, designed by Mr. Ramsbottom, may be taken as representing the most approved form of construction in that class of locomotives in 1865. The arrangements are characterised by much simplicity and elegance; but their nature is made so clear by the drawing that it is unnecessary further to describe them.

Supplying Water to Tenders while running. Mr. Ramsbottom has contrived an apparatus which, by enabling locomotive tenders to take in water while running, obviates the necessity of such numerous stoppages as were necessary heretofore. This apparatus, represented in *figs.* 76 and 77, consists of an open trough of water, lying longitudinally between the rails at about the rail level, and a dip-pipe or scoop attached to the bottom of the tender, with its lower end curved forwards and dipping into the water of the trough, so as to scoop up the water and deliver it into the tender tank whilst running along.

The water trough A of cast-iron, 18 in. wide at top by 6 in. deep, is laid upon the sleepers between the rails at such a level that when full of water the surface of the water is 2 inches above the level of the rails. The scoop B for raising the water from the trough, is of brass, with an orifice 10 in. wide by 2 in. high; when lowered for dipping into the trough, its bottom edge is just level with the rails and immersed 2 in. in the water. The water entering the scoop B is forced up the delivery pipe C, which discharges it into the tender tank, being turned over at the top

so as to prevent the water from splashing over. The scoop is carried on a transverse centre bearing *D*, and when not in use is tilted up by the balance weight *E* clear of the ground. For dipping into the water trough it is depressed by means of the handle *F* from the footplate, which requires to be held by the engineer as long as the scoop has to be kept down.

The upper end of the scoop *B* is shaped to the form of a circular arc, as is also the bottom of the delivery pipe *C*, so that the scoop forms a continuous prolongation to the pipe when in the position for raising water. The limit to which the scoop is depressed by the handle *F* is adjusted accurately by set screws, which act as a stop and prevent the bottom edge of the scoop being depressed below the fixed working level. The set screws also afford the means of adjusting the scoop to the same level when the brasses and tires of the tender have become reduced by wear, causing the level of the tender itself to be lowered. The orifice of the scoop is made with its edges bevilled off sharp, to diminish the splashing; and the top edge is carried forward 2 or 3 in. and turned up with the same object.

The water trough *A* is cast in lengths of about 6 ft., so as to rest upon each alternate sleeper, and is fixed to the sleepers, the height being adjusted by means of wood packing. The ends of each length are formed with a shallow groove, in which is inserted a strip of round vulcanised india-rubber, to make a flexible and watertight joint, the metal not being in contact; this meets all the disturbances arising from expansion, settlement of road, and vibration caused

by the passage of trains. The length of trough now laid on the Chester and Holyhead Railway near Conway is 441 yds. on the level; and at each end the rails are laid at a gradient of 1 in 100 for a further length of 16 yds., the road being raised for that pur-

Fig. 76.

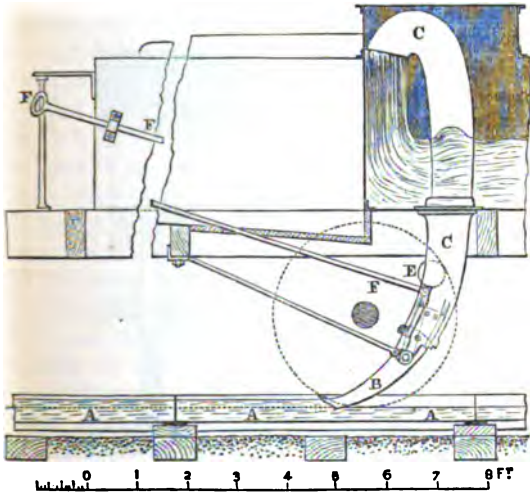

FEEDING SCOOP FOR RUNNING LOCOMOTIVES.

pose, so that the summit of the incline is 6 in. higher than the level portion: the trough is tapered off in depth to a bare plate, so that the same thickness of wood packing serves for fixing it throughout the entire length. The portion of the line where the trough is fixed is a curve of 1-mile radius, and the

outer rail is canted 1 in. above the inner, the wood packing being made taper for fixing the trough horizontal; but the cant does not interfere with the efficient action of the scoop on the tender, since it amounts to only $\frac{1}{8}$ in. on the 10 in. width of scoop.

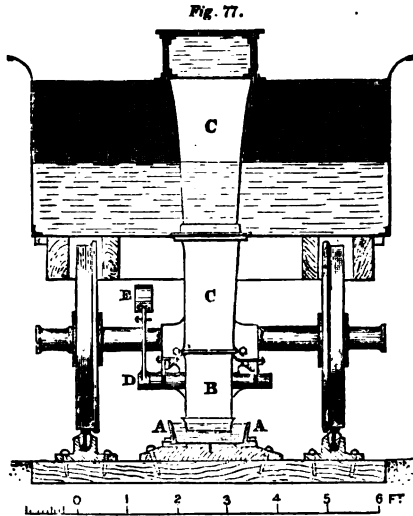

FEEDING SCOOP FOR RUNNING LOCOMOTIVES.

At each extremity of the water trough is an overflow pipe, limiting the height of water in the trough.

The trough contains 5 in. depth of water, and the scoop dips 2 in. into the water, leaving a clearance of 3 in. at the bottom of the trough for any deposit of ashes or stones. The trough is so constructed as to

present no obstruction to be caught by any loose couplings or drag-chains that may be hanging from the trains passing over it; and experiments have been tried with a bunch of hook chains and screw couplings hanging down behind the tender and dragged along the trough without any damage occurring.

As to any difficulty from ice, a thorough trial has been afforded by severe winters; and by means of a small ice plough, which was run through the trough by hand each morning, the coating of ice was removed from the surface of the water, and no more was formed afterwards excepting a film so thin that it was removed by the scoop itself in passing through the trough, without being felt at all. It has indeed been shown, that the continuance of this action with the succession of trains in ordinary working would be sufficient in this climate to prevent the formation of any ice thicker than could be readily and safely removed by the passage of the scoop alone, even during the severest seasons.

The principle of action of this apparatus consists in taking advantage of the height to which water rises in a tube, when a given velocity is imparted to it on entering the bottom of the tube; the converse operation being carried out in this case, the water being stationary and the tube moving through it at the given velocity. The theoretical height, without allowing for friction, &c., is that from which a heavy body has to fall in order to acquire the same velocity as that with which the water enters the tube. Hence, since a velocity of 32 ft. per second is acquired by

falling through 16 ft., a velocity of 32 ft. per second, or 22 miles per hour, would raise the water 16 ft.: and other velocities being proportionate to the square root of the height, a velocity of 30 miles per hour would raise the water 30 ft. very nearly (a convenient number for reference), and 15 miles per hour would raise the water $7\frac{1}{2}$ ft.—half the velocity giving one quarter the height. In the present apparatus the height that the water is lifted is $7\frac{1}{2}$ ft. from the level in the trough to the top of the delivery pipe in the tender, which requires theoretically a velocity of 15 miles per hour; and this is confirmed by the results of experiments with the apparatus: for at a speed of 15 miles per hour the water is picked up from the trough by the scoop and raised to the top of the delivery pipe, and is maintained at that height whilst running through the trough, without being discharged into the tender.

The theoretical maximum quantity of water that the apparatus is capable of lifting is the cubic content of the channel scooped out of the water by the mouth of the scoop in passing through the entire length of the trough; this measures 10 in. width by 2 in. depth below the surface of the water in the trough, and 441 yds. length—amounting to 1,148 gals. or 5 tons of water. The maximum result in raising water with the apparatus is found to be at a speed of about 35 miles per hour, when the quantity raised amounts to as much as the above theoretical total; so that, in order to allow for the percentage of loss that must unavoidably take place, it is requisite to measure the effective area of the scoop at nearly the outside

of the metal, which is $\frac{1}{4}$ inch thick and feather-edged outwards, making the orifice slightly bell-mouthed and measuring at the outside $10\frac{1}{2}$ in. by $2\frac{1}{4}$ in. ; this gives 1,356 gallons for the extreme theoretical quantity. By experiment it appears that the variation in the quantity of water delivered is very slight at any speed above 22 miles per hour, at which nearly the full delivery is obtained ; the greater velocity with which the water enters at the higher speeds being counterbalanced by the reduction in the total time of action whilst the scoop is traversing the fixed length of the trough. It also appears that at any speed above that which is sufficient to discharge the water freely from the top of the delivery pipe, all the water displaced by the scoop is practically picked up and delivered into the tender. In these experiments the water level was maintained the same in the trough each time by keeping it supplied up to the overflow orifice at each end ; and the scoop was lowered to the same level each time by means of the set screws, the height of the tender itself being maintained practically the same in each case.

The construction of this apparatus was pressed upon Mr. Ramsbottom by the accelerated working of the Irish Mail, the arrangements connected with which made it necessary that the train should run from Chester to Holyhead (a distance of $84\frac{3}{4}$ miles) in two hours. A supply of 2,400 gallons of water is found to be required for this journey in stormy weather, and it became necessary, therefore, either very much to enlarge the tender tanks, or to introduce an arrangement under which the tender could

take up water while running. The latter expedient was preferred, and it has now been matured and utilised with complete success.

Goods Engines—Glasgow and South-Western Railway. The most recent form of goods engine, constructed by Messrs. Hawthorn of Newcastle for the Glasgow and South-Western Railway, is represented in *fig. 78*. The following are the main particulars of that engine:—Diameter of cylinder, 16 in.; stroke, 22 in.; area of fire grate, 13.33 sq. ft.; heating surface of boiler, 930 sq. ft.; sectional area through tube ferrules, 1.986 sq. ft. The tubes are brass of 12-wire gauge at fire-box end, and 14-wire gauge at smoke-box end, fixed with steel ferrules at fire-box end only. Barrel of boiler 4 ft. diameter, and made of plates $\frac{7}{8}$ ths thick. The leading and driving wheels are 5 ft. diameter coupled, and have tires of cast steel. The trailing wheels are 3 ft. 6 in. diameter, and have tires of the best Yorkshire iron. This class of engines has inside bearings only to all the axles, and the boiler is supplied with water by one of Giffard's No. 8. injectors.

Coupled Passenger Tank Engine—London, Chatham, and Dover Railway. This engine, also constructed by Messrs. Hawthorn, is represented in *fig. 79*, and its principal dimensions are as follows:—Diameter of cylinders, 15 in.; stroke, 22 in.; area of fire grate, 15.75 sq. ft.; heating surface of boiler, 906 sq. ft.; area through tube ferrules, 1.963 sq. ft. The tubes are brass, of 9-wire gauge at the fire-box end, and 13-wire gauge at the smoke-box end, and are fixed at each end with malleable cast-iron

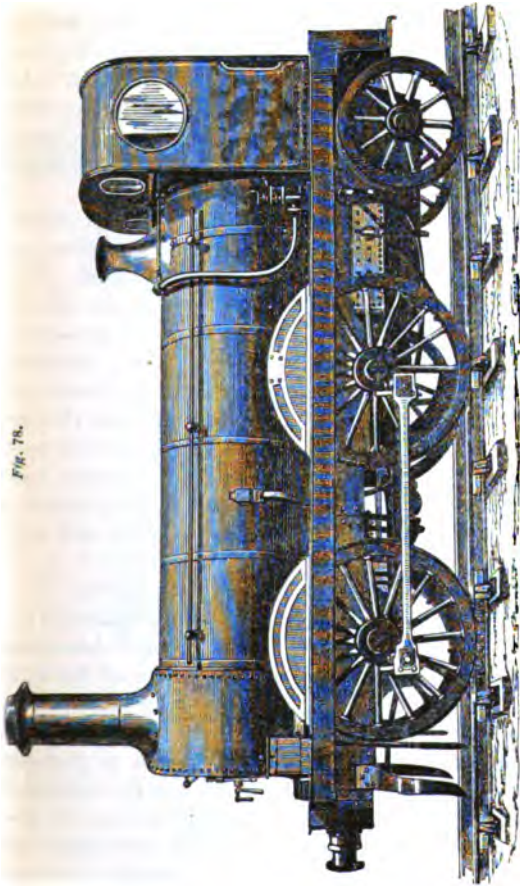

Fig. 78.

GOODS ENGINE GLASGOW AND SOUTH WESTERN RAILWAY.

ferrules. The barrel of the boiler is 3 ft. 9 in. diameter, and is made of $\frac{7}{16}$ th plate. The leading wheels are 3 ft. 6 in. diameter, and the driving and trailing wheels are 5 ft. 6 in. diameter coupled. All the wheels have cast-steel tires. These engines have both outside and inside frames, and the boiler is supplied with water by two of Giffard's No. 8 injectors.

Coupled Express Passenger Engine—Great Northern Railway. This engine, also constructed by Messrs. Hawthorn, is represented in *fig. 80*. The chief dimensions are as follows:—Diameter of cylinders, $16\frac{1}{2}$ in.; stroke, 22 in.; area of fire-grate, 14.92 sq. ft.; heating surface, 982 sq. ft.; sectional area through tube ferrules, 2.01 sq. ft. The tubes are of brass of 9-wire gauge at fire-box end, and 13-wire gauge at smoke-box end, fixed at each end by steel ferrules. The leading wheels are 4 ft. diameter, and the driving and trailing wheels of 6 ft. 6 in. diameter coupled. These engines have both inside and outside framing.

Goods Engine—Copiapo Extension Railway. This engine, represented in *fig. 81*, and also constructed by Messrs. Hawthorn, is somewhat on the American model, and it is intended to be capable of burning either wood or coal. The cylinders are outside cylinders of 16 in. diameter, and 24 in. stroke. The area of fire-grate is 15.77 sq. ft.; area of heating surface, 1,102 sq. ft.; and sectional area through tube ferrules, 2.147 sq. ft. The tubes are of brass of 11-wire gauge at fire-box end, and 14-wire gauge at smoke-box end; fixed in with steel ferrules to every



COUPLED PASSENGER TANK ENGINE, LONDON, CHATHAM AND DOVER RAILWAY

Fig. 80.

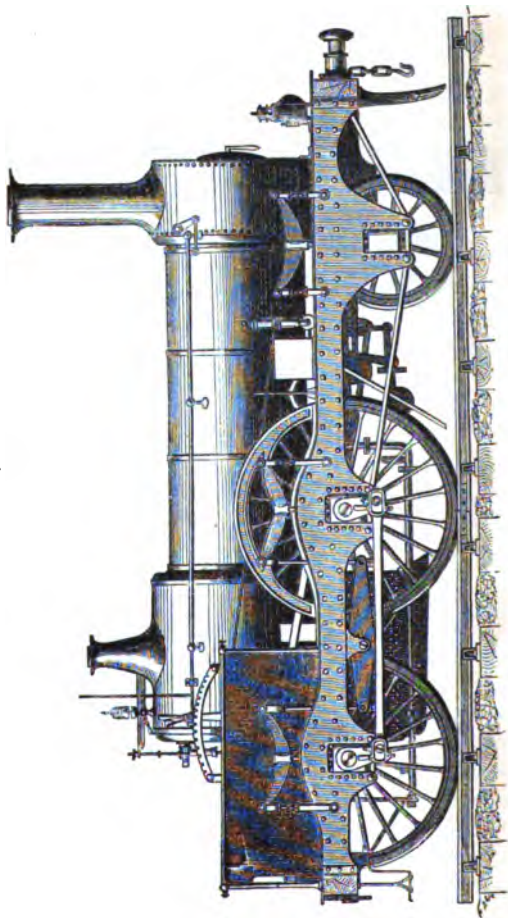

COUPLED EXPRESS PASSENGER ENGINE, GREAT NORTHERN RAILWAY.

tube at fire-box end, but with only every sixth tube ferruled at smoke-box end. The barrel of the boiler is 4 ft. 2 in. diameter, formed of plates $\frac{7}{8}$ ths thick. The fire end of the engine is carried on a four-wheeled bogie or truck, with wheels of cast-steel 2 ft. 6 in. diameter; and there are three pairs of driving wheels all coupled, made of malleable iron and fitted with steel tires. There is also a spark-catcher on the chimney, of the kind usual in locomotives where wood is burned. These engines are all fitted to work with a pressure of steam in the boiler of 130 lbs. on the sq. in.; and, with the exception of the Great Northern engine, they all burn coal. Their symmetry, simplicity, and excellent proportions furnish a remarkable contrast to some of the continental engines, and do great credit to the persons concerned in their production. The ponderous class of engines called Crampton's engines, at one time employed in this country, has now gone out of use. Their great weight was found to be very injurious to the rails.

DETAILS OF MODERN LOCOMOTIVES.

Cylinders. It is very material that the cylinders and valves should be made of as hard metal as possible, as the hardness of the metal will mainly determine the durability. Sometimes valves will run only twelve months before requiring to be renewed, and they require to be refaced at the end of six months. But Stephenson's engines run four years, and have been known to run as long as seven years, without requiring material repair. The metal of the cylinders is so hard that a file will scarcely touch it.

Fig. 81.

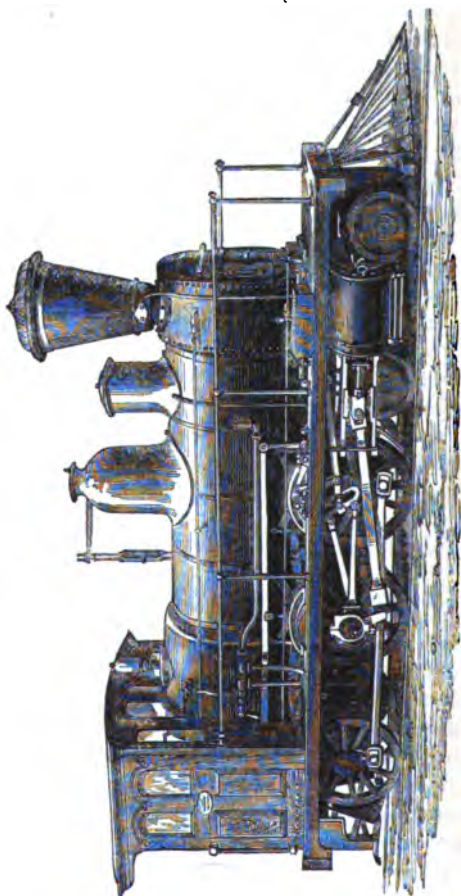

HAWTHORN'S GOODS ENGINE FOR COPIAPO EXTENSION RAILWAY.

The cylinders should always be directly connected with the frames of the locomotive, so as to discharge the whole strain upon them without communicating it to the boiler, as is the case when the cylinders are fixed to the boiler. Inside cylinders are cast in two parts, and are jointed by being scraped to an even surface. The joining surfaces should make a good joint by being greased with tallow and bolted together. The cylinders are formed with flanges for attaching them to the frames, and those flanges are planed parallel to each other: they are formed with a ledge on each side to rest on the edge of the frame, and are each bolted to the frame by twelve $\frac{3}{4}$ -in. bolts. When outside cylinders are employed, they are bolted in the same manner to the outside and inside frames. The valve casing is cast on the cylinder. The area of the steam ports is in some cases one-ninth, and in other cases one-twelfth or one-thirteenth of the area of the cylinder, and the eduction port one-sixth to one-eighth of the area of the cylinder—proportions which allow, at mean speeds of 25 to 30 miles per hour, a pressure little different from that of the steam in the steam pipes to exist. For higher speeds the ports should be larger in proportion. The valve casing is covered with a door, which can be removed to inspect the valve or the cylinder face. Some valve casings have covers upon their front end as well as on their top, which admits of the valve and the valve bridle being more readily removed.

The valve stuffing box is commonly made to receive from 2 to 3 in. of hemp packing. The best form of valve casing to afford access to the faces is formed

with a large cover underneath the cylinders, and with wrought iron end covers. The end covers can be easily taken off, and in case the cylinder faces have to be removed or filled up the large cover can be taken off, and the faces are then easy of access. With this form of chest the cylinders may be cast together in one piece. All the joints about the cylinders are made metal to metal. The cylinder barrel is $\frac{3}{4}$ to $1\frac{3}{8}$ in. thick, and the flanges are $1\frac{1}{2}$ in. thick, finished size. The cylinder and valve chest covers, when of cast metal, are from $\frac{7}{8}$ to $1\frac{1}{2}$ in. thick, and the bolts are from $\frac{3}{4}$ to 1 in. diameter, pitched from $3\frac{1}{2}$ to 5 in. asunder. The thickness of the valve chest is $\frac{5}{8}$ to $\frac{3}{4}$ in. The cylinders are joined together by 1-in. bolts from 5 to 6 in. apart. Slide valves have been made of cast iron, and they wear longer than brass; but brass is to be preferred, as it does not wear the cylinder's face so much. The body of the valve should be $\frac{3}{8}$ to $\frac{1}{2}$ in. thick, and the face $1\frac{1}{2}$ in., although some valves are as little as $\frac{3}{4}$ in. thick in the face. The exhaust cavity should be about $2\frac{1}{2}$ in. deep, and well rounded off, so as to give a free exhaustion. The end of the valve rod should be forged in the form of a square ring or frame, into which a large square projection on the back of the valve fits. This ring should have a good broad bearing surface, so as to lessen the chance of wearing loose. A cock is still placed at each end of the cylinder, to allow the water to be discharged, which accumulates there; and the four cocks of the two cylinders are connected, as heretofore, so that by working a single handle the whole are opened or shut at the same time. A cock is also sometimes fitted

to each of the covers of outside cylinders with the end formed into a swivel joint, so as to admit of being turned upwards to allow melted tallow and oil to be poured through it with the cylinder. But on the whole it is now judged preferable to use an apparatus which will feed the tallow to the cylinder continuously. A good deal of saving in tallow is accomplished by this apparatus, and the pistons are kept in better order. The valve faces are supplied with grease by oil cups, one on each side of the smoke box, provided with double cocks, so that a supply of oil may be admitted during the time the engine is at work. But here also it is desirable that the supply should be continuous.

Pistons and Piston Rods. Piston rods are sometimes made with a disc forged on one end about 3 in. thick and 6 in. diameter, a recess being bored out in the piston to receive the disc. The body of the piston is slipped down upon the rod until it encounters the disc, to which it is made fast with four $\frac{3}{4}$ -in. or $\frac{7}{8}$ -in. rivets. Sometimes the rod is only tapered into the piston and cuttered. The piston is made of cast iron or brass, but generally the latter, which is preferable to cast iron, as it does not so easily break under the action of priming and loose bolts, and it is also lighter. The thickness of the metal in the body for cast iron is $\frac{3}{4}$ to $\frac{7}{8}$ in., and for brass $\frac{5}{8}$ in. The thickness round the hole into which the rod is cuttered is $1\frac{1}{2}$ in. for brass, and for cast iron $1\frac{3}{4}$ in. The total breadth of the piston is from $2\frac{1}{2}$ to $4\frac{1}{2}$ in., and the cutters are $1\frac{1}{2}$ to $1\frac{7}{8}$ in. broad, and $\frac{5}{8}$ in. thick, tapering $\frac{3}{8}$ in. per foot. The rings are from $\frac{3}{4}$ to $1\frac{1}{4}$ in. broad, and $\frac{3}{4}$ in. thick. For soft cylinders brass

piston rings are best, but for hard cylinders cast iron rings wear very smooth and require less looking at. On the London and North-Western Railway and on some other lines a wrought iron piston is used, the rod and piston being forged in one piece. The piston is recessed on the circumference to receive the packing rings, of which there are two for a 16-in. piston. These rings are formed of brass, and one is placed in each recess or groove. Under each ring there is a steel hoop $\frac{1}{8}$ in. thick, of the same breadth as the packing ring, which is $\frac{1}{2}$ in. broad and $\frac{1}{8}$ in. thick. The depth of the recesses is $\frac{3}{8}$ in., and the thickness of the piston at that part is $\frac{3}{8}$ to $\frac{1}{2}$ in. The total breadth is $2\frac{1}{8}$ and $2\frac{1}{2}$ in., and the ends of the piston are recessed, so as to leave the body $1\frac{1}{2}$ in. thick. The brass rings are formed in two parts, and jointed with tongue pieces $\frac{1}{8}$ in. thick. The steam is admitted behind the ring through $\frac{3}{16}$ -in. holes drilled in the back. The top of the piston rod is secured by a cutter into a socket with jaws, through the holes of which a crosshead passes, which is embraced between the jaws by the small end of the connecting rod, while the ends of the crosshead move in guides. The crosshead is made of wrought iron, and the piston rod is tapered where it joins the crosshead at the rate of about 1 in 30, and is secured by a cutter $\frac{3}{8}$ to $\frac{1}{2}$ in. thick, and 2 in. broad, tapering to $1\frac{3}{8}$ in. The crosshead is placed transversely to the guide bars, and is from $2\frac{1}{2}$ to $3\frac{1}{2}$ in. in diameter at the part where it enters the guide blocks. The feed-pump rod joins the crosshead outside the guide blocks. A good form of locomotive piston is shown in *figs.* 82, 83,

Figs. 62, 63, and 64.

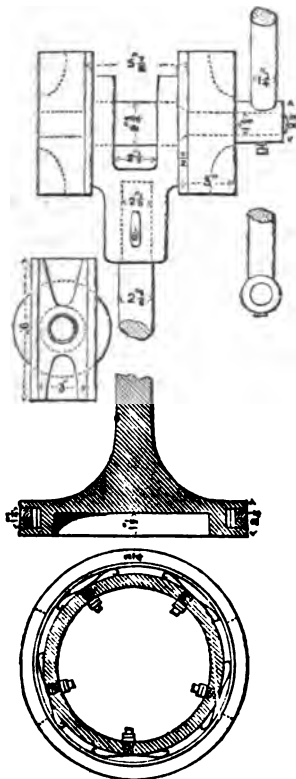

LOCOMOTIVE PISTON, CROSS HEAD, AND GUIDE BLOCK.

and 84, which also show the piston rod, crosshead, and guide blocks. The piston rod, it will be seen, is formed in the same piece with the piston. The packing rings are formed in two tiers, breaking joint with one another; and they are pressed out by springs, tightened by screws passing through the body of the piston. The cylinder bottom has a projection upon it to fit the recess in the piston, whereby waste of steam is prevented.

Guides. Most makers still attach their guides at one end to a cross stay, and at the other end to lugs upon the cylinder cover; and they are made stronger in the middle than at the ends. Some guide bars are grooved out to a depth $\frac{3}{4}$ to 1 in., being flat at the bottom, but wider at the top than at the bottom—the sides of the groove being sloped. The guide blocks are of brass; and in wearing down they maintain their position in the groove. This mode of construction prevents side play, such as occurs with flat bars and blocks with lateral flanges. Guides are best when made double, so as to admit a single-ended connecting rod. The guide blocks are commonly from 9 to 10 in. long and 3 in. broad, with $\frac{1}{2}$ -in. flanges in the case of flat bars. They are made of cast iron chilled, or wrought iron steeled. Sinclair uses cast iron for both blocks and bars, and it is said they wear well if properly attended to. I have also used the same in marine engines with the piston travelling 700 ft. per minute. Solid steel bars and brass blocks run well together. The bars are from $1\frac{1}{2}$ to 2 in. thick at the middle, tapering to 1 or $1\frac{1}{4}$ in. at both ends, and from $2\frac{1}{2}$ to 3 in. broad. They are generally fixed at

one end to the cylinder cover, and at the other end to brackets bolted or rivetted to the motion plate by two $\frac{7}{8}$ -inch bolts or rivets. An example of the ordinary kind of guide bars is given in *figs. 85 and 86*:—

Figs. 85 and 86.

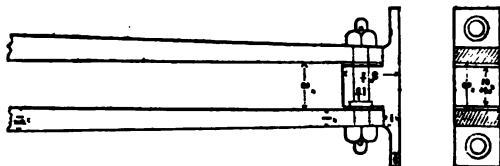

GUIDE-BARS OF LOCOMOTIVES.

Link Motion. The link motion proper for locomotives resembles the link motion as applicable to marine engines, of which I have already given examples. The valve spindle is from $1\frac{1}{4}$ to $1\frac{1}{2}$ in. diameter, and works through a stuffing box at each end of the valve chest. The end which is connected with the link motion is sometimes coupled to a square guide, which works in a socket fixed to the guide bars, and in outside cylinders to the side of the frame. On the end of the spindle is a socket secured by a cutter and jointed to a connecting rod $\frac{3}{4}$ to $1\frac{1}{4}$ in. thick, and 2 to 3 in. deep, which is, in most cases, suspended by a link from the boiler bottom and has a forked end, between which the motion or slotted link works. To each end of the slotted link an eccentric rod is coupled by a $1\frac{1}{8}$ -in. pin. The other end of the eccentric rod is attached to the eccentric strap; and thus the valve derives its motion, in the manner explained elsewhere. An example of the

slide valve and link motion, as usually applied in modern locomotives, is given in *figs.* 87, 88, and 89. In this view the valve is shown at the one end of the valve rod and the link at the other. To the ends of the link the eccentric rods are attached. The end of the valve rod nearest the link is sustained in its position by a short supporting link; but a guide would be better, as the versed sine of this link will distort the motion. The end of the valve rod joins the block which is placed within the link, and derives its motion from it.

Eccentrics and Eccentric Rods. In *fig.* 90 we have an example of the eccentric strap and rod of a modern locomotive. The eccentric is put on in two pieces secured together by cutter bolts; and it is secured on the axle by a key and also by two screw bolts penetrating a short distance into the axle. In Sinclair's Rouen Engines with straight axles the four eccentrics were cast in one piece.

Sometimes eccentrics are made of wrought iron, and are steeled by case-hardening. Generally the smaller half of the eccentric is now made of malleable iron, though the larger half may be made of cast iron. When thus formed the weakest part is $\frac{3}{4}$ in. thick. If the eccentric be wholly of cast iron, it should be $1\frac{1}{2}$ in. thick in the weakest part. In addition to a pinching screw it should be secured by a key, let $\frac{1}{2}$ in. into the shaft, and $\frac{1}{2}$ in. into the eccentric. Most eccentrics have square grooves turned on the edges, into which fits a corresponding internal flange on the hoop or brass. The ordinary form of eccentric and hoop is shown in *fig.* 90.

Figs. 87, 88, and 89.

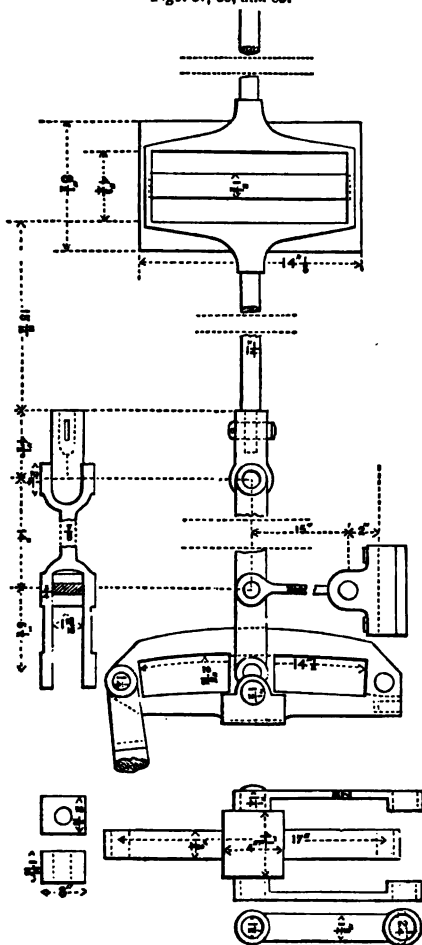

LOCOMOTIVE VALVE, LINK-MOTION, AND CONNECTIONS.

Fig. 90.

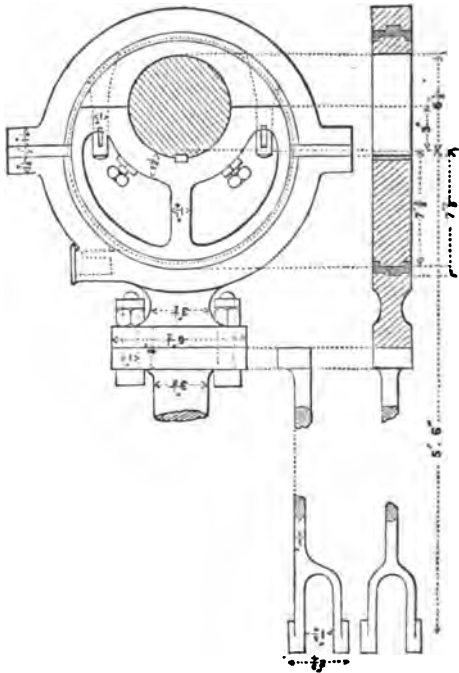

LOCOMOTIVE ECCENTRIC WITH ECCENTRIC STRAP AND ROD.

Mineral Locomotives. A class of locomotives is employed at collieries, and to carry iron ore and other minerals, of a cheaper construction and a smaller size than the common locomotives. At the Great Exhibition in 1862, Messrs. England & Co. exhibited an

engine with 11-in. cylinders, six wheels—four of them coupled—of 4 ft. diameter, and with 153 tubes $1\frac{1}{2}$ in. diameter in the boiler. Messrs. Manning, Wardle & Co. of Leeds exhibited a colliery locomotive with 9-in. cylinders, four wheels coupled, of 2 ft. 9 in. diameter, and 55 tubes of 2 in. diameter in the boiler; the area of the grate being 4.9 sq. ft., and the pressure of steam 120 lbs. per sq. in. The Neath Abbey Iron Company exhibited a locomotive adapted for running on a gauge of 2 ft. 8 in. It had 8-in. cylinders, four coupled cast-iron wheels of 2 ft. 4 in. diameter, and 59 tubes in the boiler, $1\frac{1}{2}$ in. diameter and 6 ft. long. The area of grate was 3.5 sq. ft., the total area of heating surface 181 sq. ft., and the weight 6 tons 17 cwt. With steam of 66 lbs. pressure it could draw 12 waggons, each weighing $4\frac{1}{2}$ tons, at a speed of 8 miles an hour.

A very good example of a mineral locomotive engine is represented in *fig. 91*, which is a form of mineral tank locomotive engine, constructed by Messrs. Fletcher, Jennings & Co. of Whitehaven, who have devoted themselves to the special manufacture of this class of engine. In this engine the valve gear is worked from the fore axle so as to enable the hind axle to be got under the fire box, and thereby reduce the overhanging weight. The water is carried in tanks beneath the foot plate and under the barrel of the boiler. Messrs. Fletcher, Jennings & Co. have constructed numerous engines of this class for gauges of 2 ft. 3 in., 2 ft. 8 in., and 2 ft. 10 in., which are common gauges of the railways conveying minerals from the Welsh mines.

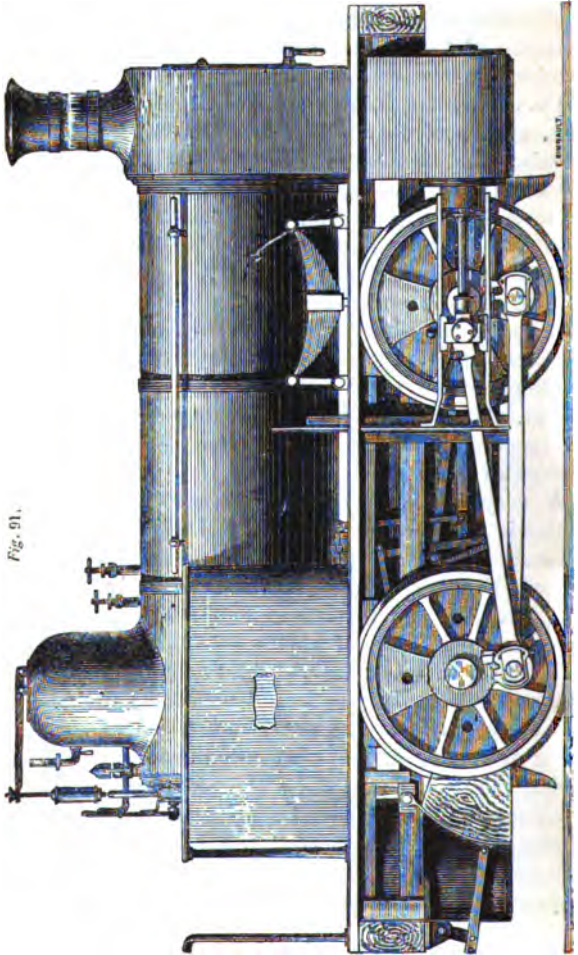
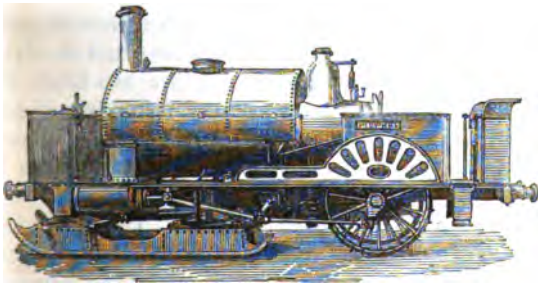

Fig. 91.

MINERAL TANK LOCOMOTIVE, BY FLETCHER, JENNINGS AND CO., WHITEHAVEN

Locomotive for Running on Ice. Fig. 92 represents a locomotive for running upon ice, constructed by Messrs. Neilson of Glasgow, and reported to have been successfully employed in conveying goods and passengers on the Neva between St. Petersburg and Cronstadt during the winter months. The front part of the engine rests on a sledge, which is capable of being moved round a centre by a pinion gearing

Fig. 92



LOCOMOTIVE FOR RUNNING UPON ICE, BY MESSRS. NEILSON OF GLASGOW.

into a segment, and worked by the steering wheel shown at the front, which gives motion to an endless screw gearing with a suitable wheel, which turns the spindle of the pinion round with great force; and by swivelling the sledge—which, however, would be better done by a small engine—the machine is steered. The after part of the engine rests upon two driving wheels 5 ft. diameter, the peripheries of which are studded with steel spikes to grip the ice. The cylin-

ders are of 10 in. diameter and 22 in. stroke. The weight of the engine is 12 tons, and it realises a speed of 18 miles an hour. It will be proper in such an engine to apply a shelving edge on each side of the sledge, so that its swivelling may not be prevented by sinking somewhat into the ice or beaten snow; and to the same end the swivelling gear should be powerful and under easy and rapid control under the worst circumstances likely to occur. In Russia and in Sweden extensive lakes and other tracts of water, being frozen in winter, are available for the application of such an apparatus. But in some of the lakes there are warm springs which create holes in the ice; and the desideratum to be aimed at is to render available the little vessels which ply in summer for plying also in winter by mounting them on a sledge, as was proposed by me to be done for some lakes in Sweden in 1847.

Locomotives for Common Roads. The rapid extension of railways in this country has nearly superseded the necessity of employing steam carriages on common roads, which at one time appeared likely to be extensively introduced. But in other countries not possessed of the same highly-developed system of locomotion the use of steam traction on common roads is still very important. In 1843 I described in the 'Artizan' an arrangement whereby the power of the engine of a common road locomotive might be communicated to the wheels without interfering with the free action of the springs; and ever since 1847, when I first went to India, I have continued to urge the employment of suitable locomotives upon the great

roads of that country. In 1862, being then at Lahore, and finding that there was one of Boydell's traction engines at Bombay, which had been sent out for the government, but had never been used, I purchased it and had it conveyed to Moultan, and it went under steam from thence to Lahore, a distance of about 200 miles, over one of the worst roads in India. This journey, however, owing to exceptional circumstances, was not accomplished without considerable difficulty. From lying so long at Bombay, the woodwork of the shoes had become rotten, and the shoes had consequently to be taken off altogether on the road, when the engine sank in the soft ground ; and it had in several instances to be extricated with considerable difficulty. I found, moreover, that special provision required to be made on many points to make the engine suited for such roads, which are not only filled with ruts and soft, but in summer are deep in dust, and during the inundations deep in mud. The dust, during the journey I referred to, rose over the surface of the shoes, and was lifted up by them and scattered in the air ; and each spoke of the wheel acted as a scoop to lift up the dust and precipitate it over the engine. The evils presented by such difficulties, however, are not insuperable, but they indicate the necessity of covering over every working part of the engine so effectually that dust cannot enter, and also of not trusting to wood at all in such a climate in the construction of any of the parts. The shoes, or rather pattens, should be formed of wrought iron or steel boxes, 6 in. deep ; and I think it would be preferable to have their movements governed by a central cam

or eccentric, as in a feathering paddle-wheel, instead of leaving them to assume their respective positions from the action of gravity alone. The geared wheels and pinions should be formed of steel, as also most of the parts of the engine should be, to reconcile lightness with strength.

Boydell's engine is represented in *fig. 93*. It resembles a locomotive, the fore wheels of which are made to swivel by proper steering gear; and the main part of the weight is carried on the driving wheel, which is encircled by a series of boards called an 'endless railway,' which successively place themselves on the ground in advance of the wheel, and the wheel then passes over them without sinking in the ground. In fact they act on the principle of the snow shoe in giving area proportionate to the softness for sustaining the weight. No doubt improvements in the details of these engines may be suggested; but the principle is sound, and the modifications required to adapt them to conditions, such as obtain in an exotic country like India, cannot be anticipated by manufacturers at home, but must be indicated by persons on the spot who are determined to make the engines answer, instead of searching for some petty pretext to justify their condemnation. In connection with the movements of the army in India, such engines would be of signal value, to say nothing of the operations of agriculture; and the time has now come when the rise in the value of labour in India and the increasing demand for Indian produce—coupled with the improvements in steam cultivation at home—must open the doors of that great country, heretofore and even

yet sealed up by the narrow policy of an exclusive oligarchy—now changed rather in name than in fact—and present a new field of effort and of emolument to the enterprise of the British engineer. No country

Fig. 93.

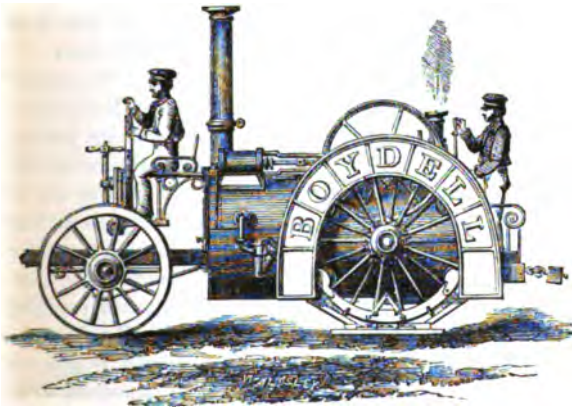

BOYDELL'S TRACTION ENGINE.

in the world is better suited than India for the application of steam cultivation. It consists in great part of vast alluvial plains, which may be mapped out into any shape judged suitable for steam culture; and as, with irrigation, three crops in the year may be calculated on, the apparatus may be kept in almost constant use for ploughing, or reaping, or threshing. Fuel is scarce in some parts, but may easily be cheapened by planting trees of rapid growth.

Bray's Traction Engine. This engine, which

prevents sinking by using wide wheels, and prevents slipping by causing short spades to project at pleasure from the surface of the driving wheel by means of an eccentric on the driving axle, is represented in its original state in *fig. 94*; but the Company has since availed itself of the abilities of Mr. Clark in the production of a more perfect engine, which has now more of the locomotive type about it than before.

In Aveling's Patent Traction Engine, *fig. 95*, manufactured by Messrs. Aveling & Porter of Rochester, there is a single cylinder surrounded by a steam jacket, which is in direct communication with the boiler by means of steam ways or orifices made in the top of the boiler. There will be little tendency to prime in this engine, as the cylinder is brought to the forward part of the engine, and on ascending inclines the cylinder is necessarily fed with dry steam; while, in descending, little steam is required. By this arrangement the use of steam pipes either inside or outside the boiler is dispensed with. Engines with single cylinders and reversing gear, connected to the driving axle by chain gear, have proved themselves to be perfectly efficient. They are less complicated, and on the whole are better adapted for general traction purposes than engines with double cylinders.

The working parts are housed in from the influence of the weather. The toothed gearing is also covered with light iron splashers. The propelling gear consists of a pinion at each end of the crank shaft (either of which can be thrown in and out of gear with the spur wheel below by sliding it along a feather on the crank shaft) working into spur wheels

Fig. 94.



BRAY'S TRACTION ENGINE.

on a counter shaft below. On this shaft is a chain pinion with chilled teeth, to take in a pitch chain made of wrought iron links with steel pins. In the brackets carrying the shaft there are curved slots, struck from the centre of crank shaft above, for taking up the slack of the endless driving chain. These pinions are kept in the positions required by means of a simple clip of spring steel embracing the shaft, and lined with leather. The adjustment for taking up the slackness of the chain is effected by the brass bearings carrying the shaft being kept up in the slot by a block at the bottom of each. There is another cast iron block above, lying on the bearing, and kept down by a set screw. When the chain has to be shortened, the thinner block below is taken out, and the thicker one above is substituted in its stead. The brass step is thus fixed in a perfectly firm and solid adjustable bearing. The gearing is connected to the driving wheels by means of the endless chain, passing round the chain pinion on the counter shaft and a large chain wheel keyed on the axle. The driving wheels are 6 ft. 6 in. diameter; on the face of the wheels is an outer tire, parts of which may be removed and replaced by angle iron paddles or clips, for use in passing over soft and yielding ground.

The boiler is carried through from end to end, without any break in the configuration, whereby the use of angle iron is dispensed with. The stay bolts of the fire-box are pitched $4\frac{1}{2}$ in. from centre to centre. The fire-box is adapted for burning wood or coal fuel. The water for feeding the boiler is carried in a tank made of wrought iron plates and bolted to the side

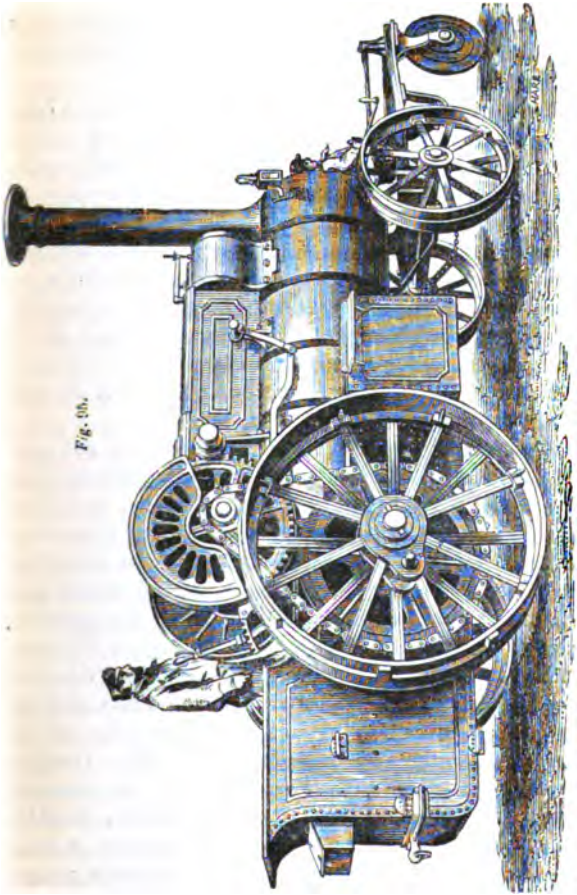

Fig. 96.

AVELING AND PORTER'S TRACTION ENGINE

plates of the fire box, which are carried out for this purpose. The draw bar is formed of π iron, the ends of which are returned, or bent back, and bolted to the wrought iron side plates of the tank.

The steerage is effected by a single disc wheel carried on the lower end of a vertical spindle, supported in a collar-bearing on the front end of a pair of angle iron shafts secured to the fore carriage of the engine. The upper end of the vertical spindle is provided with a lever-handle extending back towards the steersman, who is seated between the shafts at the front end of the engine. This engine is capable of ascending inclines of 1 in 12, with a load of 20 tons, and with 8 tons will ascend an incline of 1 in 6. On a level road in fair condition it will haul 40 tons with ease.

One hundred and thirty of these engines are now in use in different parts of the world, and are used in sugar and coffee plantations, and in copper and lead mines, in dockyards, and wherever large quantities of materials and heavy weights have to be removed. Messrs. Aveling & Porter have manufactured and exported these engines to Russia for the government, to Jamaica, Queensland, Java, Egypt, Prussia, Buenos Ayres, &c., &c.; and the increased demand proves that steam power on common roads, and in new colonies, is now attracting the attention which its importance and utility justify. For feeding the traffic of railways steam traction on common roads is particularly valuable. In India, branch railways have been projected for this purpose, which were at one time intended to have a narrower gauge

than the ordinary railways of that country. But the injudicious break of gauge has now been abandoned, and all railways, whether trunk or branch, established to carry on the communication of the country, are intended to have the same gauge. Prior to the formation of a railway, however, it is advisable to make a metalled common road on which traction engines may run; and when the traffic has thus been by degrees nursed up to a certain point of magnitude, it will become advantageous to lay down rails for the engines to run upon. This is the proper course of development in a new or undeveloped country; and the construction of expensive lines of railway in districts covered with jungle, and destitute of population, cannot be justified by any principle of reason or any indication of common sense.

Aveling's Patent Agricultural Road Locomotive, designed for steam cultivation, threshing, sawing, and removing agricultural produce, is represented in *fig.* 96. The boiler, like that already described, is unusually large and is flush; it is clothed with hair felt, lagged and covered with sheet iron from end to end. The cylinder and working parts are, like those of the engine, intended exclusively for traction purposes. The gearing, however, is single, and for one speed only. There is a pinion on the end of the crank shaft, working into a spur wheel on a stud below; and on this wheel is cast a chain pinion to take in the endless pitch chain. This gearing works on the stud in a curved slot in the lower part of one of the crank shaft brackets, struck from the centre of the crank shaft. In the side of the bracket is an adjusting set screw,

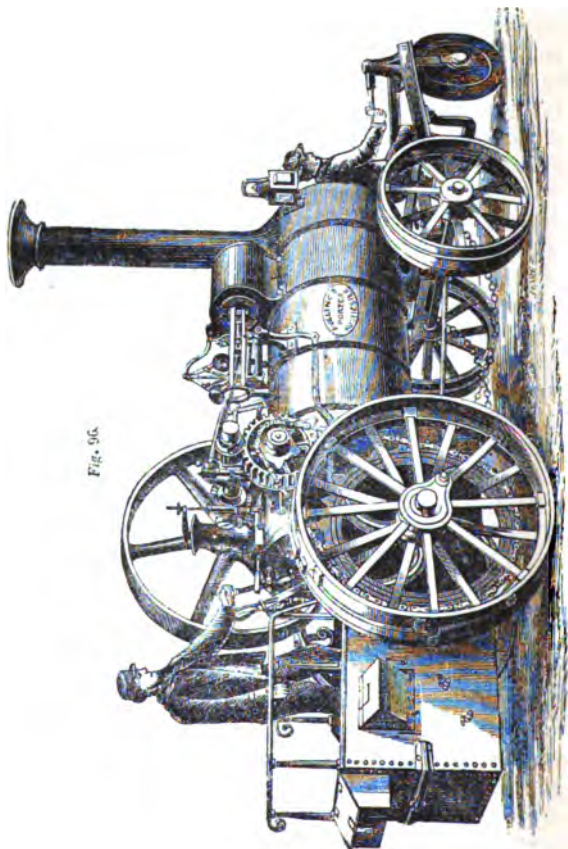

Fig. 96.

AVELING AND PORTER'S AGRICULTURAL ROAD LOCOMOTIVE.

working through a tapped boss, and bearing at its inner end against the side of the stud shaft. By turning this screw the stud shaft may be caused to slide laterally in the curved slot, as this slot in the bracket is struck from the centre of the crank shaft, and by this arrangement the stud shaft may be adjusted to any desired amount, so as to tighten up the driving chain without interfering with the gearing together of the spur wheel on the stud and the pinion on the crank shaft.

The spur wheel receives motion from the pinion, which slides laterally by means of a groove and feather on the end of the crank shaft, but always revolves with the shaft. The object of this lateral adjustment of the pinion is to throw it in or out of gear with the spur wheel, so that, when the engine is not required to travel over the ground, the locomotive gear may be thrown out of action; and the engine can then be immediately employed to drive ploughing, threshing, sawing, or any other machinery, in the same manner as ordinary stationary or portable engines.

On the axle of the road wheels is a large chain wheel, round which and the chain pinion an endless chain passes, connecting it to the driving gear already described.

The road or driving wheels are loose on the axle, but are driven by a bolt passing through a boss on the nave and through the chain wheel on the one side, and on the other through a hole cast in the friction break, which, like the chain wheel, is keyed upon the axle. The object in connecting the wheels

with the driving gear in this manner is to enable either wheel to be readily disconnected, which is a great advantage in turning very sharp curves. But a self-acting clutch may also be used for this purpose. The driving or road wheels are 5 ft. 6 in. in diameter, and 16 in. broad on the face; there is a 5 ft. fly-wheel for driving machinery when the engine is disconnected from the locomotive gearing. There are now many of these engines that have travelled from 4 to 6,000 miles, moving from farm to farm, with a threshing machine attached, over the worst roads in England at all seasons of the year. The saving of horse labour in this instance alone is far from being unimportant. The engine is none the less suitable for common farm purposes from being able to move itself about from place to place; and many years ago I suggested, in my 'Catechism of the Steam Engine,' the expediency of such a combination.

An engine very much resembling Messrs. Aveling & Porter's Farm Traction Engine is constructed by Messrs. Robey & Co. of Lincoln. This engine is represented in *fig. 97*; and an engine by the same makers, adapted to the general purposes of steam locomotion on common roads, is represented in *fig. 98*. Messrs. Robey & Co.'s portable engine is the same species of engine as that shown in *fig. 96*, but without the locomotive gear.

In traction engines for common roads the objects to be fulfilled are now different, so far as regards use in this country, from what they were in 1830 when Gurney, Hancock, Ogle & Summers, and various other engineers introduced steam carriages on the

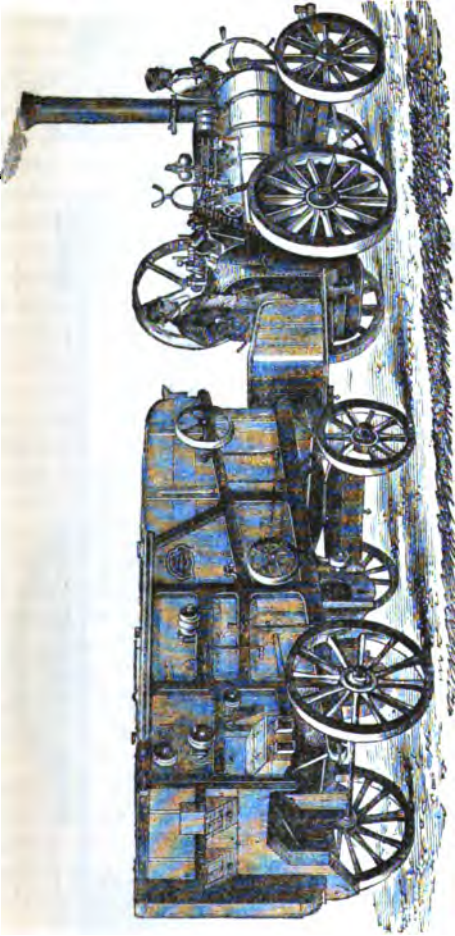
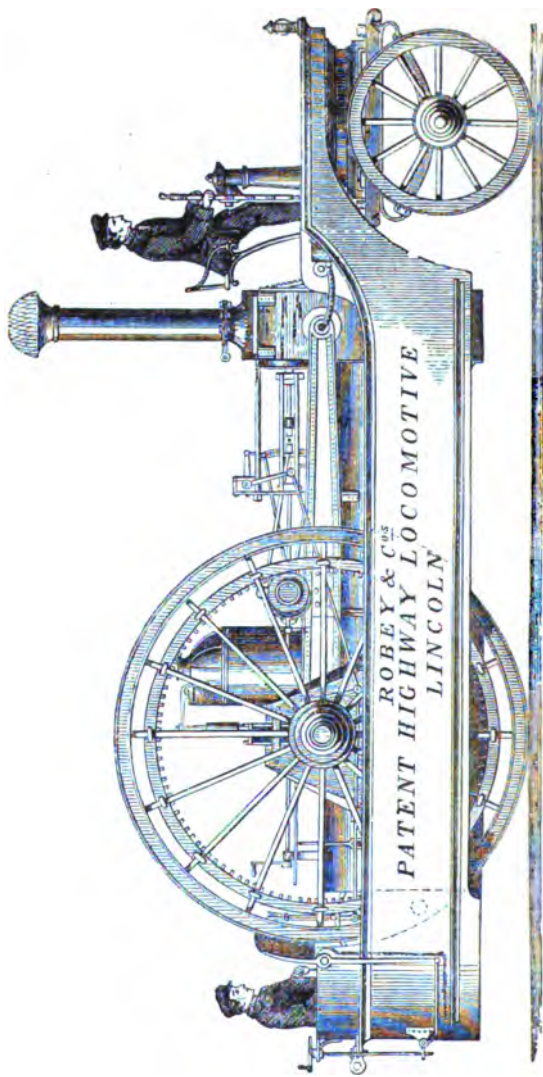

Fig. 07.

ROBEY AND CO.'S FARM TRACTION ENGINE

Fig. 98.



ROBEY AND CO.'S HIGHWAY LOCOMOTIVE

common road, some of which machines were characterised by much mechanical ability. At that time the design was to supersede stage coaches. But this end has been attained by railways more completely than could be done by any form of steam apparatus on the common roads. Although, however, steam coaches are no longer required in England, steam waggons may be made a valuable expedient of internal transport for domestic purposes, or as ancillary to railways; while in foreign countries less developed than England, and still without railways in many districts, steam coaches on the common road may be made a valuable intermediate improvement, and rails may finally be laid down when the traffic has risen to such a point as to warrant the expenditure.

The form of traction engine constructed by Messrs. Garrett & Son, represented in *fig.* 99, nearly resembles one of the forms employed by Messrs. Aveling & Porter; and most of these forms, it will be observed, are the natural developement of the common portable farm engine, which common sense indicates should be made capable of being put to as many useful purposes as possible.

Messrs. Clayton, Shuttleworth & Co's Traction Engine is represented in *fig.* 100. This engine is substantially the portable engine of the same makers, with some additions; and in 101 there is another form of their portable engine adapted for pumping water.

One of the most important applications of the portable engine is to the work of steam ploughing, for

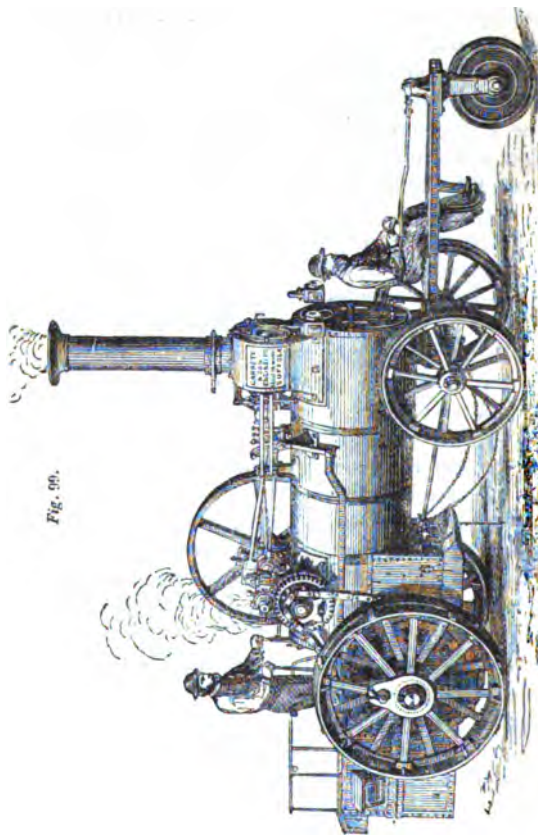
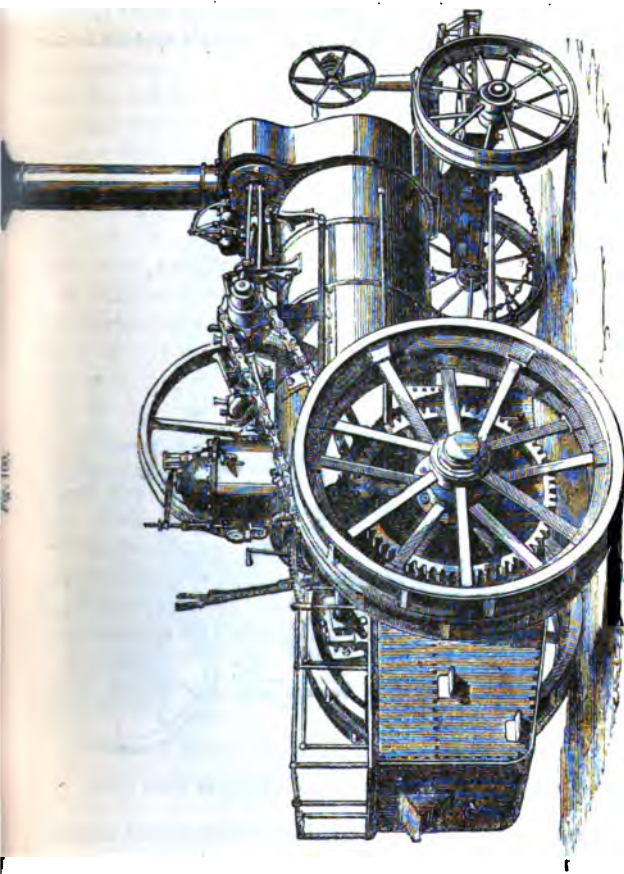

Fig. 99.

GARRETT AND SON'S TRACTION ENGINE FOR COMMON ROADS.



CLAYTON, SHUTTLEWORTH AND CO'S TRACTION ENGINE.

P

which each principal manufacturer has some special arrangement. That known as Savory's system is re-

Fig. 101.

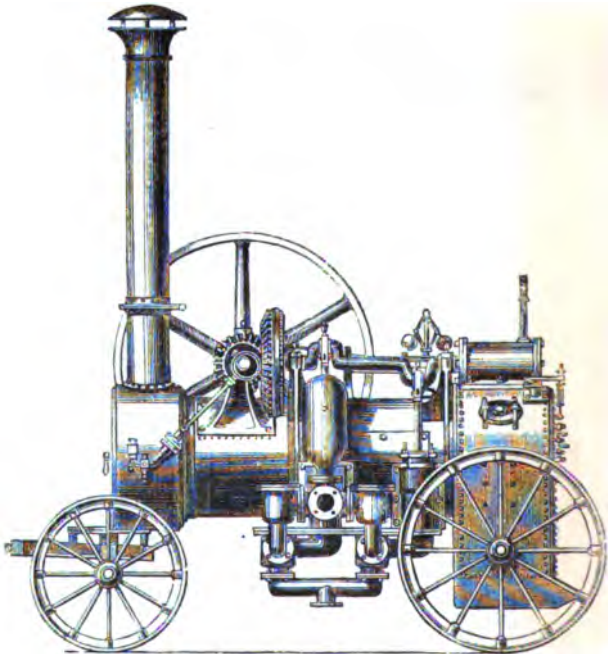

CLAYTON, SHUTTLEWORTH AND Co.'s PORTABLE STEAM PUMP.

presented in *fig. 102*. By this plan an engine suitable for winding a rope is placed on each side of a field, and the engine on the one side winds up a rope pass-

ing across the field which the other engine unwinds.

Fig. 102.



SAVORY'S SYSTEM OF STEAM PLOUGHING, BY R. GARRETT AND SON.

The plough is attached to this rope, and it is drawn to one side and to the other by each engine

alternately, each advancing a short distance along the field for every cut that is made. The form of engine which winds up the rope is shown on a larger scale in *fig. 103*. The engine is a common portable engine, with a great drum encircling the horizontal part of the boiler, on which drum the rope—which is best made of steel wire—is wound. These engines are capable of travelling from place to place, carrying their own water and fuel.

The advantages of this system as compared with other methods proposing to accomplish the work with one engine, are, that only one rope passes across the field instead of two, and that the shifting of anchors intended to hold the pulley on which the return rope runs is obviated altogether, as also is the injury caused by the rope running over a comparatively small pulley, as this movable pulley generally is. The disadvantages are that the expense of two engines is incurred, and that one is standing idle half its time while the rope is being drawn across by the other. I have very great doubts, however, whether the method of ploughing by a rope at all is the proper one, or whether it is advisable to imitate the operation of ploughing, which is confessedly an imperfect one, since it does not sufficiently break up and pulverise the soil. It appears to me that some species of steam digger is the proper instrument to employ, which will pass over the field digging up a whole furrow at once. No doubt such an instrument would require a great deal of power to drive it: But the work done would be proportionate to the power expended, and one such machine hired out would suffice for many farms.

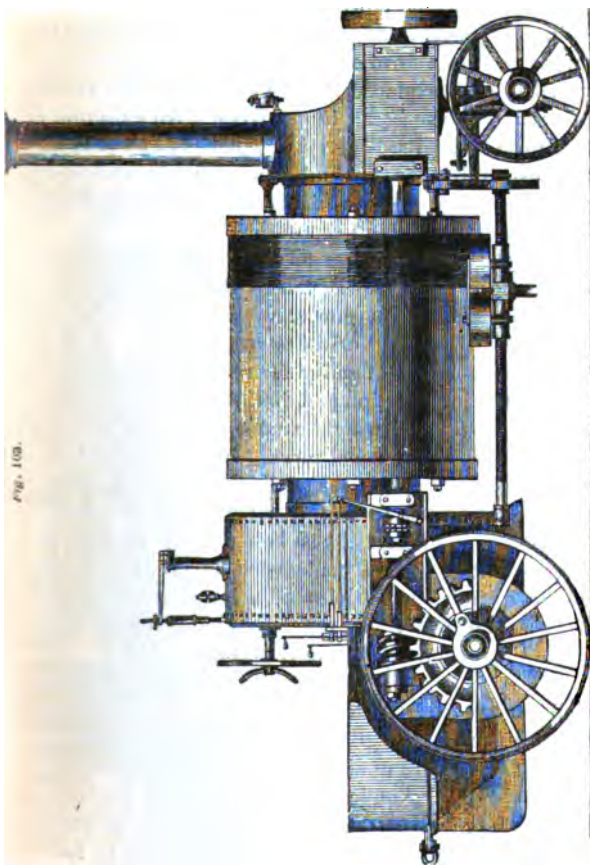

Fig. 103.

PORTABLE ENGINE, BY R. GARRETT AND SON, FOR SAVORY'S SYSTEM OF STEAM PLOUGHING.

The increasing power of agricultural engines has induced Messrs. Ransomes & Simms to employ for the larger powers a form of combined engine, consisting of two engines placed side by side, with the cranks at right angles, as in locomotives. An example of this form of engine is given in *fig.* 104; and it is distinguished by the faithful workmanship and good proportions by which Messrs. Ransomes & Simms have earned their high reputation.

In *fig.* 105 is shown a form of cylindrical boiler, patented by Messrs. Biddell & Balk, and manufactured by Messrs. Ransomes, which enables the fire box and tubes to be withdrawn from the shell or barrel, so as to give facility for removing and cleaning out the incrustation and dirt, which is so injurious in some cases, and which cannot easily be removed from boilers of the usual form. In this patent boiler the back tube plate, as well as the front outside plates, are bolted to flanges rivetted to the shell of the boiler. These flanges being truly placed, the steam-tight joints are made with as great a facility as the cylinder-cover joint of a large steam engine. Where the water is very dirty and leaves much deposit, this boiler is strongly recommended.

These boilers, as well as the ordinarily formed boilers, are constructed with especial reference to durability and strength. The bulk of the plates are of best Yorkshire quality, the remaining plates being Staffordshire. Ample water space is given round the fire box and between the tubes, so as to ensure free circulation of the water. Each boiler is tested to double its working maximum pressure.

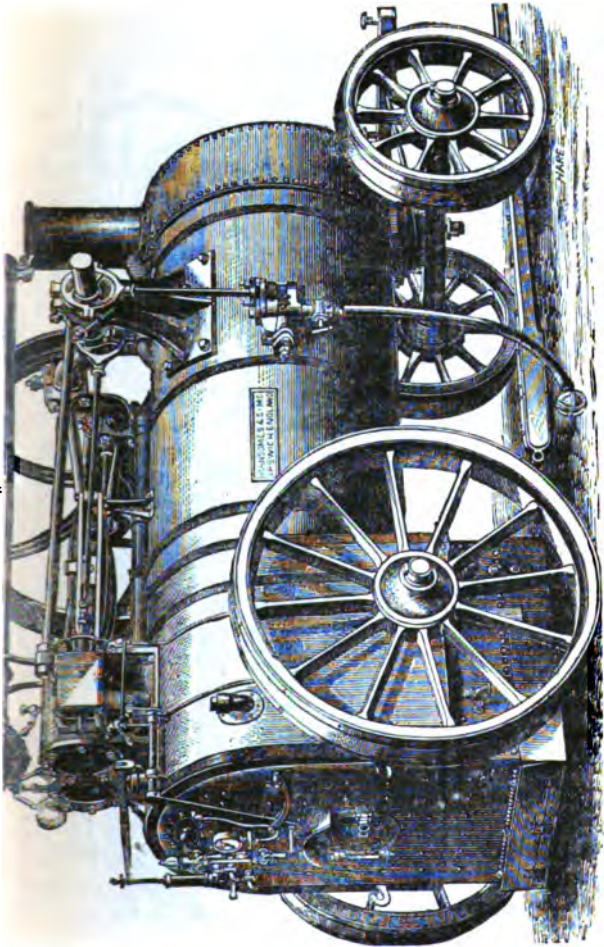

RANSOME AND SIMS' COMBINED PORTABLE ENGINE, 20 HORSE-POWER.

Fig. 104.

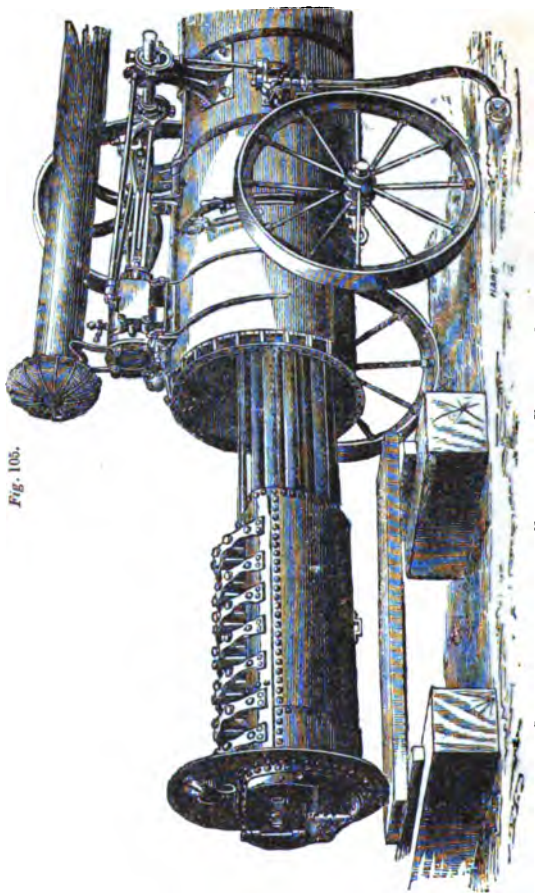

Fig. 105.

BOILER WITH REMOVABLE FURNACE AND TUBES, BY RANSONES AND SIMMS.

The boilers are mounted upon iron or wooden wheels, according to the wish of the purchaser, but iron ones are recommended as generally more durable and better adapted for change of climate.

Among the lightest forms of steam engine which have been hitherto produced, the steam fire-engines constructed to pump water for extinguishing fires must be accorded a prominent place. In the case of towns supplied with water maintained at a high pressure in the pipes, the simplest mode of extinguishing fires is to apply a proper hose and spout pipe direct to the distributing main. But in the case of towns where this high pressure in the water-pipes does not exist, and in cases also where there are no water-works, but, nevertheless, valuable property to be preserved, the use of steam fire-engines appears to be highly important. Such engines are much more effective than engines worked by hand, as the requisite power to work the pumps is always present, and as it acts with greater concert and less intermission than any number of men could do. For inflammable capitals like Constantinople, where the houses consist chiefly of wood, and there is no high pressure of water available for the extinction of fires, the use of steam fire-engines is peculiarly important, and is now beginning to attract much attention. In dockyards also, railway workshops, arsenals, and in fact in all isolated and important establishments, the value of such a powerful expedient for extinguishing fires is now beginning to be adequately apprehended. It has long been found that in all great fires the volume of water thrown on the burning mass by the jets of existing

hand engines has been quite too small to extinguish the flames, and in fact the water has in many cases never reached the burning matter at all, but has been raised into steam before it could fall on the spot on which it has been directed. The use of steam appears to be indispensable to enable very large and powerful jets to be obtained, which would in all cases reach their intended destination, and would produce the extinguishing effect due to the refrigeration which a very large volume of water would necessarily cause.

The introduction of steam fire-engines has often been proposed, but, until lately, has been prevented by various practical impediments, of which one has been the great weight of steam engines of the ordinary description. In America, however, large numbers of steam fire-engines have been made, but many of them have been of a very complicated and precarious construction, and in this country none of them have been much adopted. In England, however, the makers of the ordinary hand fire-engines have begun to turn their attention to the subject; and both Messrs. Shand & Mason, and Messrs. Merryweather & Son, of London, have produced numerous steam fire-engines marked by special features of excellence and promising good results. Messrs. Shand, Mason & Co. manufacture two varieties of steam fire-engine, in one of which the cylinder is horizontal and works a horizontal double-acting pump affixed to the end of the piston rod; and the stroke is measured by a vertical slot in an enlarged part of the piston and pump rod, which permits the

crank pin to move up or down in the manner usual in donkey engines for feeding boilers. The valve of the engine is worked by an eccentric in the usual manner, and the pump-valves are india-rubber discs, falling on a grating in the manner first introduced by Mr. Edward Humphrys, though few persons are now cognisant of the parentage of an improvement which has now become of almost universal application. The boiler consists of a fire box formed like the frustum of a cone, the better to disengage the steam from the inclined surface of the plate, on which is set a cylinder removable by bolts to contain the tubes. From the top of the frustum a number of very small and short copper tubes, set vertically very closely together, conduct the smoke into the chimney. The engine is provided with a small fly-wheel in the usual manner of donkey engines. In their vertical form of engine the boiler is the same as has been already described, but the engine is set with the cylinder inverted, and the pump is of the combined plunger and piston form invented by Mr. David Thomson, and first introduced by him in the Richmond Waterworks in 1845. In this form of pump the valves are like those of a common single acting pump, and the area of the plunger is half the area of the piston or bucket. As the piston ascends, the pump sucks itself full of water in the usual manner; but when the piston descends, the water being forced through the valves in the bucket into the space above the bucket, which is too small for it, inasmuch as half the area is occupied by the plunger, it follows that half the water will be forced through the delivery,

valve when the bucket is descending. The water left in the annular space between the side of the pump and the side of the plunger is forced out when the piston or bucket ascends; and we thus have the benefit of a double-acting pump with the gear of a single-acting one. The plunger is open at the top so as to constitute a trunk, and it is properly bolted to the bucket. The trunk and bucket are moved by means of two piston rods proceeding through the cylinder cover, one being placed on one side of the shaft, and the other diagonally on the other side of the shaft. The arrangement in fact very closely resembles that of Messrs. Napier & Sons' original form of direct-acting screw engine, except that in that case the engine was horizontal. The air pump answers to the water pump in this case; and from the bottom of the trunk a connecting rod proceeds to the crank to turn it round. On one end of the crank shaft is placed a small fly-wheel, and on the other end is an eccentric for working the slide valve, and also the pump employed to feed the boiler. A small piston, acted upon by the water which is being forced out, governs the speed of the engine by opening or shutting the throttle valve.

Messrs. Shand, Mason & Co.'s horizontal steam fire-engine is represented in *fig.* 106, and their vertical steam fire-engine is represented in *fig.* 107. The performance of each class of engine is very nearly the same, and in an experiment made with one of these engines at Messrs. Penn & Son's factory in 1864, with an engine having two cylinders of $6\frac{3}{4}$ in. diameter, and 7 in. stroke, the power generated with

steam of 120 lbs. pressure in the boiler, and with 152 revolutions per minute, was about 15 horse-power. In the case of another engine of the same

Fig. 106



SHAND, MASON AND Co.'s HORIZONTAL STEAM FIRE-ENGINE.

dimensions, also tried in 1864, the power generated with a little increase in the pressure of the steam was 18-horse power, and the total weight of this engine with its appurtenances was 24 cwt. 2 qrs. In an engine which Messrs. Shand, Mason & Co. sent to the competitive exhibition at Middleburgh, in Holland, in July 1864, and for which they obtained the

222 RECENT IMPROVEMENTS IN THE STEAM ENGINE.

gold medal and 500 guilder prize, there was only one cylinder of 7 in. diameter and 8 in. stroke. In an experiment made with this engine, a jet of water $1\frac{1}{8}$ in. diameter was projected under a water pressure

Fig. 107.

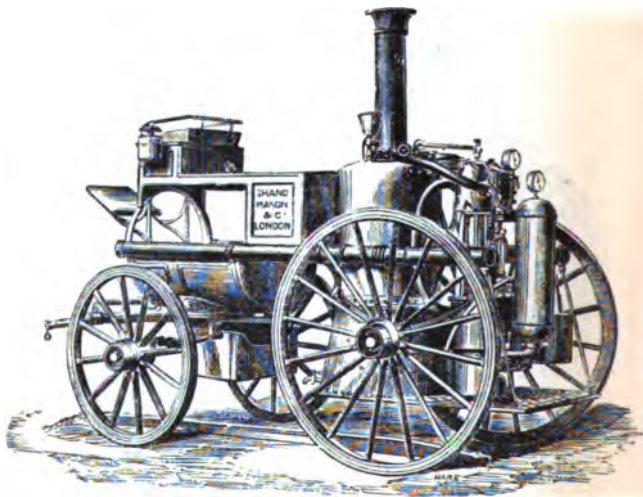

SHAND, MASON AND Co.'s VERTICAL STEAM FIRE-ENGINE.

of 125 lbs. per sq. in. With steam of 145 lbs. pressure in the boiler, an average pressure of 128.15 lbs. per sq. in. was maintained upon the piston at a speed of 165 revolutions per minute, and $5\frac{1}{2}$ lbs. per sq. in. of back pressure. In this case the engine exerted $32\frac{1}{4}$

actual horse-power; and as the total weight of the engine was only 32 cwt. the weight was about 1 cwt. per actual horse-power. As this is a very remarkable result, I here introduce a copy of the indicator diagram taken at the time.

Fig. 108.

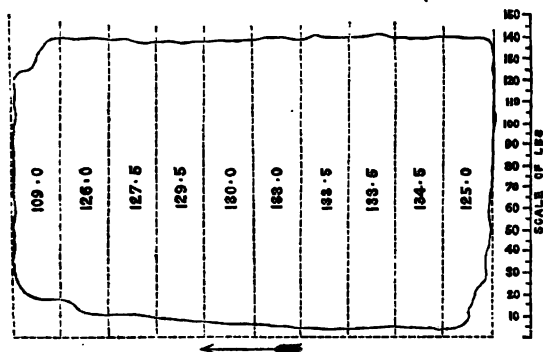

INDICATOR DIAGRAM FROM SHAND, MASON AND Co.'s STEAM FIRE-ENGINE

Having personally examined Messrs. Shand, Mason & Co.'s engines when in course of construction, I can vouch for the faithfulness of the work; and I was also favourably impressed with the intelligence which presided over the general arrangements of these machines. But in the boiler the tubes are so thickly set, that it will be important to use pure water so that there may be no incrustation, which, if considerable, would prevent the access of the water and cement

the tubes into a solid mass. It is a necessity of all fire-engine boilers, however, that they should have but little water in them, so that the steam may be quickly got up; and as such engines are never required to work for long periods at a time, there is abundant opportunity for cleaning the boilers out. By making the upright cylinder which encircles the tubes removable by unscrewing a few bolts, as these makers have done, they provide in a great measure against the only objection that can be made to any of their arrangements.

Prior to the introduction of steam fire-engines, Messrs. Merryweather & Son of Long Acre had obtained a high reputation in the construction of hand fire-engines, and also in the construction of other fire apparatus; and in turning their attention to the construction of steam fire-engines they brought to the problem the ripened experience that they already obtained in other analogous constructions. There are two main features in the mechanism Messrs. Merryweather employ in their steam fire-engines:—the one is in the boiler, which consists of a number of pendulous tubes hung in a furnace with a smaller internal tube within each, to enable the circulation of the water to be carried on; and the other is in the circumstance of the engine being without a crank, but the pump is worked by being attached to a reciprocating piston, as in Worthington's steam pump, or in the form of donkey engine introduced by Messrs. Penn, but subsequently abandoned; while the valve of one engine is moved by the other if there are two engines, and by a small independent cylinder and piston if

there is only one engine, the valve of this small starting engine being itself moved by a tappet. The benefits which Messrs. Merryweather consider that they obtain by these peculiar features are, first, that in their form of boiler the steam is more rapidly got up than in any other, and certainly in this respect their engine seems to have the advantage over all its competitors; and second, that inasmuch as there is less waste of power in moving water slowly than in moving it rapidly, and as their pump and engine, with their long stroke and large capacities, move more slowly than is the case in other steam fire engines, there will be a gain from this source also, and the engine will consequently work with a maximum efficiency. Although, however, there is a loss of power in moving water quickly rather than in moving it slowly, the velocity of the water escaping from every species of pump must be the same to project a jet of the same diameter to the same height; and whether the plunger of the pump moves fast or slow the escaping water must have the velocity proper for the kind of jet that has to be employed. It consequently will matter little whether the water obtains its velocity directly from a fast moving plunger, or indirectly from the compression of the water which a larger plunger moving more slowly produces, seeing that in each case the water must leave the spout-pipe with the same velocity, and must carry away with it a corresponding amount of power. But whether the engine moves fast or slow a crank is equally applicable, and a crank will enable the engine to work with less waste of steam at the ends, as there will no longer be any neces-

sity to leave the same clearance at the ends to obviate the risk of striking. Every species of reciprocating engine which is without a crank, is more or less of a rattle-trap; and although the example of the Cornish engines shows us that such engines are capable of pumping water with great efficiency and without intermission for long periods of time when moving slowly, yet it is now found that rotative pumping engines are quite as efficient, while they certainly work in a smoother and less precarious manner, and are capable of maintaining higher speeds without inconvenience. On the large scale, the pumping engine without a crank has been practically given up: and the same considerations which make that abandonment advisable on the large scale make it equally advisable on the small.

The consideration of the properties and performance of the steam fire engines exhibited at the International Exhibition of 1862 was delegated to a special committee. But two engines of Messrs. Shand, Mason & Co., and one of Messrs. Merryweather and Son, were the only engines which presented themselves to be experimentally tested. All the boilers were filled with cold water, and Messrs. Merryweather & Son's engine got steam up to 100 lbs. pressure in 12 minutes and 10 seconds, and Messrs. Shand, Mason & Co.'s first engine in 18 minutes and 30 seconds, whilst in their second engine, owing to some mismanagement which compelled them to draw the fire, 30 minutes were consumed. Messrs. Merryweather & Son's engine was 2 minutes and 50 seconds at work before it began to draw water. Nevertheless it pro-

jected 500 gallons of water into a tank 60 ft. distant in 17 minutes and 15 seconds from the time at which the fire was lighted, but the steam fell 15 lbs. during the first trial, and after three trials the engine became disabled. It resumed work, however, in an hour and a half, at the ninth trial, having been repaired on the ground in that time; but on the thirteenth trial it was again disabled. Messrs. Shand Mason & Co.'s engine, though longer in getting up the steam, drew water immediately it was put on, and during the first trial the pressure in the boiler fell only 5 lbs. per sq. in. This engine worked without accident, and almost without intermission, throughout the day. The seventeenth trial lasted 63 minutes, and the pressure in the boiler was kept up at 90 lbs. per sq. in. throughout. This experiment only confirms the anticipations which might have been reasonably formed from the distinctive features of the two engines placed in competition; and there can be no doubt that, on the whole, engines without a crank will be found more liable to derangement than those which are provided with that valuable appendage.

In July 1863 the experiments with these engines and several others were resumed at the Crystal Palace, and much interest was excited by the event. The engines presented for experiment were those of Messrs. Merryweather & Son, Shand & Mason, Easton & Amos, Butt & Co., Roberts, Nichols (Manhattan) and Gray & Son. The principal particulars of the several engines are exhibited in the following table:—

Name of Maker.	Weight of Fire Engine.	No. of Cylinders.	Diameter of Cylinders.	Length of Stroke of Piston.	No. of Pumps.	Diameter of Pumps.	Gallons of Water in Boiler.	Cubic Content of Steam Space in feet.	Area of Fire Box Surface in square feet.	Area of Tube Surface in square feet.	Total Area of Heating Surface in square feet.
	t. cwt. qt. lb.		in.								
Merryweather & Son . . .	2 18 0 8	2	8	24 in.	2	6½ in.	30 to 90	19 to 9	14.5	192.5	207
Shand, Mason, & Co. . .	2 17 1 0	2	8½	9 in.	2	7 in.	28½	7 cu. ft. 860c. in.	19½	108	127½
Easton & Amos	2 18 3 12	2	9½	8½ to 9 in.	4	2 of 5½ 2 of 6½	41	11.05	37	173	210
Butt & Co. . .	2 14 0 4	1	10½	12 in.	1	6	62	9.5	16½	183½	00
Roberts . . .	1 19 1 4	1	7	13 in.	1	9½	12½	6597 in.	23	118	141
Nichols (Manhattan) . . .	2 10 1 4	1	9	8½ in.	1	rotatory	38	7.25	48.5	133.5	182
Gray & Son . . .	1 18 1 4	1	9½	8 in.	1	7	17½	3.855	21.74	53.45	75.19

The boilers of these different engines were very various. In Merryweather and Son's boiler the shell was formed of homogeneous iron, $\frac{5}{8}$ of an inch thick double rivetted, and the tube and top plates of Lowmoor iron, $\frac{1}{2}$ thick; stays of Bowling iron, 1 in. thick, and the tubes of copper. The height of the boiler was 60 in., and the diameter 45 in. Shand, Mason & Co.'s boiler was an upright cylindrical iron boiler of 45 in. diameter at the fire-box, 45 in. at the barrel, and 60 in. high. The smoke passed through vertical brass tubes on its way to the chimney.

In Easton & Amos's boiler there was a central furnace surrounded by a shell of vertical tubes 2 in. diameter. Butt & Co.'s boiler was an upright tubular boiler 36½ in. diameter, and 65 in. high. The fire-box was 20 in. high, and there were 313 tubes of 1½ external diameter. In Roberts' boiler the body was 30 in. diameter, and 24 in. deep, and there were 248 tubes ¾ in. diameter inside. Nichol's Manhattan engine was fitted with Lee and Larned's annular boiler; and

Gray & Son's boiler consisted of a cylinder fitted with tubes revolving slowly on trunnions within an iron casing lined with fire clay.

On the first trial the task set to all the engines was to deliver 1,000 gallons of water into a tank 67 ft. distant, the water in all the boilers being cold when starting, and the order in which this was done by the different exhibitors was: 1, Easton & Amos; 2, Merryweather & Son; 3, Shand, Mason & Co.; 4, Butt & Co., and 5, Roberts. In the second trial, which consisted in doing the same work with the steam already up, the order of rapidity with which the work was done by the different exhibitors was as follows: Shand, Mason & Co., Butt & Co., Merryweather & Son, Roberts, and Easton & Amos. In subsequent trials the engine of Messrs. Merryweather & Son worked with great efficiency, and took the first prize of 250*l.*, the second prize of 100*l.* being awarded to Messrs. Shand, Mason & Co. The steam fire engine Sutherland, which achieved these successes, is represented in *fig.* 109, and Messrs. Merryweather & Son's description of this engine is as follows:—

This engine has two steam cylinders, each 8 $\frac{5}{8}$ in. in diameter, with pistons of 24 in. stroke. The two pump cylinders are 6 $\frac{1}{2}$ in. in diameter, and the pistons of the pumps being on the same rods as the steam pistons, make the same extent of stroke. Both steam cylinders and pumps are fixed horizontally on the wrought iron side frames of the engine, and rigidly connected together by strong tie-rods running throughout the entire length of cylinder and pumps. The valve motion is of a simple character, and is so arranged that when one piston is changing stroke the other is in the middle of its stroke, thus imparting a very uniform and steady motion. On the middle of each piston rod is keyed a boss carrying a short arm projecting horizontally. Parallel to and at a short distance from each piston-rod, are fixed in suit-

Fig. 109.

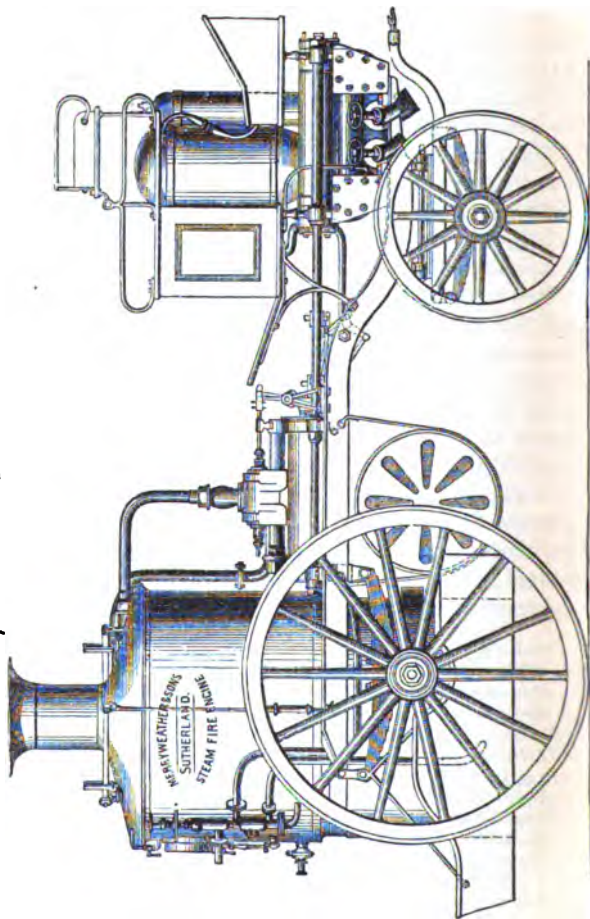

STEAM FIRE ENGINE SUTHERLAND, BY MESSRS. MERRYWEATHER AND SON.

able bearings, so as to be able to revolve freely on their axes, two twisted bars or quick screws, having a pitch of 1 turn in 16 in. At the ends of these twisted bars or screws next the steam cylinders are cut two strong square-threaded screws, having 1 turn in $1\frac{1}{4}$ in., on to which are fitted 2 gun-metal nuts, which nuts are received by the forked ends of the weigh-shaft levers for moving the slide-valves. To the short arms on the piston-rods above mentioned are attached 2 gun-metal sliding pieces, which clasp, and move freely on the twisted bars or screws, and having the same motion as the piston-rods, impart a slow, easy, reciprocating rotating motion to the twisted bars or screws, causing the gun-metal nuts and weigh-shaft levers to be brought backward and forward with a slow, easy action, thus moving the slide-valves into the required position—viz., that of closing steam and exhaust ports shortly before the end of the stroke, thus preventing the possibility of striking the ends of the cylinders. By this arrangement, each cylinder cuts off its own steam and exhaust, and is entirely independent of the other for forming the cushion required to stop the momentum of the pistons. Thus, *each piston brings itself to rest*; but when at half-stroke, by means of a connection between the weigh-shaft levers, it gives steam to No. 2 cylinder, the piston of which brings itself to rest and liberates No. 1 piston, and so on alternately.

The slide-valves are of the equilibrium piston form, and with full steam (150 lb. per sq. in.) can readily be moved by the hand with a force of 5 lb., thus saving power which is more usefully employed in forcing water.

The engine is started merely by opening the steam valve, which can be so regulated as to allow it to run as slow as half-a-stroke per minute, and has no dead points or centres.

The pump has all its valves below the pump cylinders, and so arranged that no water remains in the pump when at rest, so that it cannot freeze. The suction valves, 4 in number, are each 10 in. long and 1.375 in. wide, with a lift of 1 in., which presents an area of 13.75 sq. in.; the delivery valves, also 4 in number, are each 10 in. long, and 1.25 in. wide, with a lift of 1 in., and an area of 12.5 sq. in.; the whole are made of gun-metal, india-rubber faced, but gun-metal valves can be fitted if preferred. The engine is fitted with 4 deliveries, each $2\frac{1}{2}$ in. in diameter, for attaching hoses, and the suction hose is $5\frac{1}{2}$ in. diameter.

The side cover of the pump can be readily removed and the valves and seats re-adjusted if necessary.

The side frames are of Bowling angle iron, firmly secured together by wrought iron cross-stays, and pivoted over the fore-carriage, so that the engine may travel on the roughest road. Beneath the front part of the frame, and below the pivot, are the wrought iron fore-carriage and front wheels, which lock completely round and under the frame of the engine.

Above the pump, and fore and aft of the copper-suction and delivery air vessels, are the tool-boxes and seats for the driver and ten men. The delivery hose is carried in a cylindrical drum (capable of containing from 500 to 600 ft. of leather hose), attached beneath the frame near the boiler.

The vertical boiler has very large steam and water spaces, with a tubular circulating shell of homogeneous metal $\frac{5}{8}$ in. thick, and double rivetted. The tube and top plates are of Low-moor iron $\frac{1}{8}$ in. thick; the stays are of Bowling iron of 1 in. in diameter, and the tubes are of solid drawn copper. The height of the boiler is 5 ft., and the diameter 3 ft. 6 in. When the engine is at work, the boiler contains on an average 60 gals. of water; the steam space varies from 9 to 19 cubic ft.; the fire-box surface is 14.5 sq. ft., and the tube surface 192.5 sq. ft., making a total heating surface of 207 sq. ft.

The top plate is provided with four hand-holes, so that the interior of the boiler can be got at most readily. The top and bottom tube plates are connected together by strong wrought iron stays. The boiler is fitted with two large safety valves, two pressure gauges, back and front, No. 5 Giffard's injector, water-glass, gauge cocks, &c. There is also a steam jet in the chimney for assisting the draught. A portion of the outer shell of the boiler is kept down below where it is rivetted to the lower tube-plate to which the side frames are attached, so that the bolts do not go into the water or steam space of the boiler. At the lower part of the boiler is attached a large bunker for carrying coals or other fuel.

The engine is mounted on four springs and high wheels, so that it is suited for the most rapid travelling.

The steam fire-engine Torrent, which has obtained some celebrity in connection with Captain Hodges' fire-brigade, in consequence of its efficient action at various fires, is represented in *fig. 110*. Messrs. Merryweather & Son's description of this engine is as follows:—

Fig. 110.

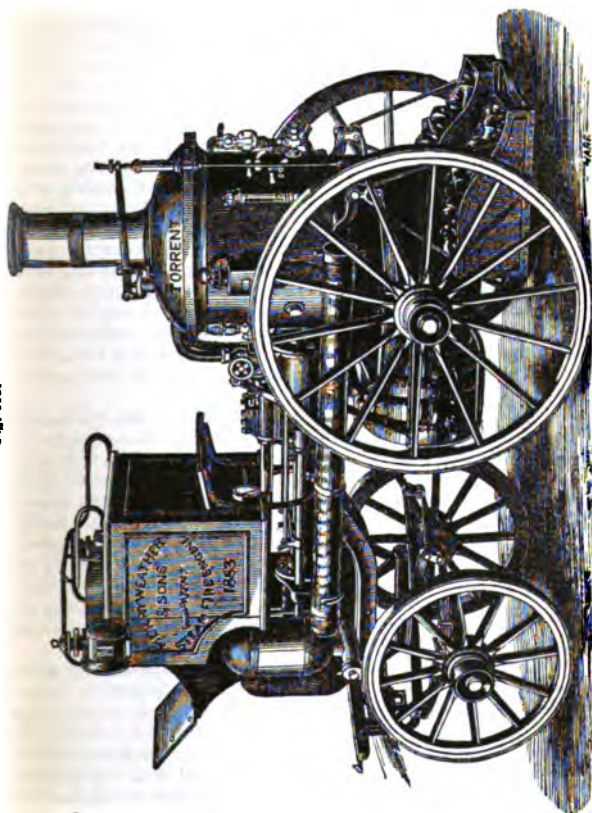

STEAM FIRE ENGINE TORRENT, BY MESSRS. MERRYWEATHER AND SON.

This engine has undergone some very severe tests, and proved to be efficient in every respect, its arrangements being of so simple a character, that ordinary persons have managed it with but very little previous knowledge of the mechanism of a steam fire-engine. It has a steam cylinder of $6\frac{1}{2}$ in. diameter, with a piston stroke of 12 in. The steam and water pistons are continuous. The pump is $4\frac{3}{4}$ in. in diameter, with a stroke of 12 in., the cubic contents of which are 1.45 gals. The arrangement for moving the slide valve, which is of the piston equilibrium form, is of the simplest kind. In the centre of the piston-rod a light cross-head is keyed, having a slight bearing upon each of the tie-rods which connect the steam cylinder and pump together; to this cross-head are attached two light rods, which are again connected to two small weigh-shaft-levers, which give a slight motion as the piston advances and recedes, to an ordinary flat valve, that admits steam to a small piston which is on the same rod as the piston slide valve. This engine can be started at any point by merely opening the steam valve, and can be driven at any speed (so as to adapt itself to any quantity of water) even as slow as one stroke per minute, as there are no dead points or centres.

The suction valves, of which there are two, are 9.5 in. long and 1.3625 in. wide, with a lift of 1 in., and an area of 10 sq. in., and the two delivery valves are 9.5 in. long, and 1 in. wide, with a lift of barely 1 in. and an area of 9.5 sq. in. The whole of the valves are of gun metal, leather faced (india-rubber can be used if preferred), and are placed below the pump cylinder, readily accessible, and so arranged that no water can possibly remain in the pump when at rest (to prevent freezing). It has two delivery outlets of $2\frac{1}{2}$ in. each, and a suction of $3\frac{1}{2}$ in., all inside diameter. The frame is of Bowling angle iron, pivoted over the fore-carriage and front wheels, which lock and turn completely under the main part of the engine.

The boiler is of steel, with Lowmoor iron tube and top plates, and vertical water tubes; the tube-plate is flanged to form a mud pocket, which receives all the deposit and from which it is easily blown out. The top plate has four hand holes, so that the interior of the boiler is easily accessible. The boiler is 48 in. high, the diameter being 28 in. The shell is of homogeneous metal, full $\frac{1}{4}$ in. thick. The tube and top plates are $\frac{5}{16}$ in. thick, and the tubes are of solid drawn homogeneous copper. The quantity of water contained in the boiler, when at work, is from 15 to 30 gals. The steam space is about 4 cubic ft., the fire-box

surface 7.5 sq. ft., including flue surface, and the tube surface 57 sq. ft., making a total of 64.5 sq. ft. of heating surface. The boiler is fed by a Giffard's injector, by the main pump, and by a feed pump. It is fitted with a safety valve, a double steam pressure gauge, a water pressure gauge, water gauge, gauge cocks, &c., and has a small steam jet for assisting the draught.

The wrought iron frame of the engine is attached to a portion of the outer shell of the boiler, left for the purpose below the water and steam spaces. At the bottom of the boiler are attached the coal-bunkers, and below the frame, in front of the boiler, is an iron frame for carrying the hose.

The frames of the engine are made of steel $\frac{3}{8}$ in. thick, and attached to the back and front plate of the boiler. Transverse to the frames, and over the cylinders, is a steel and wood frame combined, and at the back and front, a central longitudinal frame terminating at the smoke-box. The cross leading frame is also of steel, to which the steering spindle fork is attached. The slides of the main axle are inclined to divert the percussions on the main springs, and to keep the centres of the spur-gear in their most fitting relative positions. The whole weight of the boiler and the principal part of the machinery is borne by the driving wheels, which sustain each $2\frac{1}{2}$ tons weight to promote their adhesion, while the power of the engine is such as to make them skid round in 'reverse' when it is found necessary to stop *instantly*; the engine is also fitted with a break. The motion consists of spur-gear in duplicate 5 to 1, which allows the steam pistons to make 650 ft. per minute, or about half the speed of the carriage. There is also a universal differential motion applied to the main axle. Provision for causing the driving wheels to move at different degrees of speed, when it is necessary to do so, and to pass readily over any obstacles on the road, is made by the line of the steel cranked shaft, or first motion which moves in bearings fixed to the boiler and frames, and that of the second motion, or main driving axle, being often in different planes. The first motion and boiler all take the average undulation of the road, and the second motion has, on uneven roads, a continued elevation and depression at either end.

The main shaft is a bar fitted with a centre cross pin and two bevel wheels or couplings free to move in any way. On this centre bar are two more bevel wheels, and the two driving wheels are respectively connected firmly together by wrought iron pipe shafts, which move freely upon the centre shaft. Upon these external shafts the spur wheels are fitted free, and driven

by the two pinions fast on the first motion crank axle. The two spur wheels actuate the two bevels first mentioned, and also the central shaft by two driving bars, each of which moves freely on the three points of contact, allowing the two spur wheels to keep unremitting connection with their respective pinions, at all the various positions in the planes of the two axles, transmitting to the central bevel wheels their united power, through the two universal driving bars. When the carriage moves along a straight road, these bevel wheels merely act as circular clutch couplings; but in passing round curves, they revolve in part, allowing either driving wheel to take the inner curve, or, if necessary, to become stationary, while the other wheels make a circuit round it. The driving wheels are each 4 ft. in diameter and 7 in. wide, and are made of cast bosses and steel spokes and rim, with outer segments and exterior felloes of wood. Upon these are bolted segments which admit of elongation and substitution, without interfering with the rest of the wheel. The cylinders are each 6 in. in diameter, with a stroke of 8 in., and the link-motion is the same as in railway locomotives, with an extra expansion link-motion for forward gear, which allows a constantly free exhaust, and a cut off at any part of the stroke up to $\frac{3}{8}$. This, with Gray's variable blast pipe, and short tubes of ample size, enables the exhaust to be freed at a minimum pressure, keeping up a constant working pressure of 150 lbs. The steering apparatus is simple and can be managed with great ease, as there is but one leading wheel, the obstructions of the road being yielded to by the vertical axis and its appliances. To assist this forked steering shaft, and allow it to rise and fall, as well as turn freely, a parallel motion is arranged, so as to transmit the longitudinal strain received by the wheel to a fixed pin level with its axle, and made fast to the frame between the cylinders, the parallel rods having a universal hold of a beam lever, and also the ends of the axle of the leading wheel.

A soft metal plug is inserted in the boiler, in the event of no water being found along the roads, that will immediately put out the furnace fire. The engine is fitted with two steam whistles, gauge glass, water cocks, and two steam pressure gauges, one for the stoker, and the other for the driver and steerer.

Messrs. Merryweather, in common with Messrs. Shand, Mason & Co., have been able to produce steam fire-engines weighing not more than a cwt. per actual

horse-power, and they find that the engines most in demand are those with single cylinders weighing from 26 to 27 cwt., and those with double cylinders weighing from 35 to 40 cwt. The pumps have their valves so arranged, that they deliver their water at the lowest part, so as to prevent the accumulation of grit or other obstructions in the valves by causing the valve seats to be swept at each stroke by the effluent water. The only want I see in Messrs. Merryweather and Son's engines is a crank, and the sooner they introduce it the better.

At the International Exhibition of fire-engines held at Middleburgh, in Holland, in July 1864, Messrs. Merryweather and Son's engine obtained the silver medal, and 200 guilder prize; and the makers allege that their engine would have done still better than it did, only that before the trial their boiler had been working with salt water and that some of the salt still remained. Medals and inferior prizes were awarded to Messrs. A. Bickers & Son, Rotterdam; F. Requilé and Beduwé, Liege; Peek Brothers, Middleburgh; and W. C. Pasteur & Co., Rotterdam.

Ice-making Machines. One of the most remarkable applications of the steam-engine is to the manufacture of ice; which is accomplished by forcing the heat out of air by mechanical compression, and then by again allowing the compressed air to expand. Such demand is thus created for the restoration of the heat before forced out as to produce a great reduction in the temperature of surrounding objects. On the occasion of my first visit to India in 1847, the inconveniences caused by the heat drew my at-

tention to the subject of artificial refrigeration, which I proposed to accomplish by compressing air until its temperature became so high that its surplus heat would be readily extracted by the application of cold water; and then by allowing this air subsequently to expand under such circumstances as to generate power, a very low temperature it was plain would be produced which might be regulated to suit the requirements of a practical system of refrigeration. Subsequently the same idea was propounded by various other parties; and an ice-making machine has been constructed in which the refrigeration is produced by power aided by the agency of ether. But in Kirk's machine for producing cold the ether is discarded and air alone is used, which air is passed through a regenerator as in Stirling's air engine. This machine is now in successful use in Young's Paraffine Works in Scotland.

A CATECHISM
OF THE
STEAM ENGINE.



MECHANICAL PRINCIPLES

OF

THE STEAM ENGINE.

CLASSIFICATION OF ENGINES.

1. *Q.*—WHAT is meant by a vacuum?

A.—A vacuum means an empty space; a space in which there is neither water nor air, nor any thing else that we know of.

2. *Q.*—Wherein does a high pressure differ from a low pressure engine?

A.—In a high pressure engine the steam, after having pushed the piston to the end of the stroke, escapes into the atmosphere, and the impelling force is therefore that due to the difference between the pressure of the steam and the pressure of the atmosphere. In the condensing engine the steam, after having pressed the piston to the end of the stroke, passes into the condenser, in which a vacuum is maintained, and the impelling force is that due to the difference between the pressure of the steam above the piston, and the pressure of the vacuum beneath it, which is nothing; or, in other words, you have then the whole pressure of the

steam urging the piston, consisting of the pressure shown by the safety-valve on the boiler, and the pressure of the atmosphere besides.

3. Q.—In what way would you class the various kinds of condensing engines?

A.—Into single acting, rotative, and rotatory engines. Single acting engines are engines without a crank, such as are used for pumping water. Rotative engines are engines provided with a crank, by means of which a rotative motion is produced; and in this important class stand marine and mill engines, and all engines, indeed, in which the rectilinear motion of the piston is changed into a circular motion. In rotatory engines the steam acts at once in the production of circular motion, either upon a revolving piston or otherwise, but without the use of any intermediate mechanism, such as the crank, for deriving a circular from a rectilinear motion. Rotatory engines have not hitherto been very successful, so that only the single acting or pumping engine, and the double acting or rotative engine, can be said to be in actual use. For some purposes, such, for example, as forcing air into furnaces for smelting iron, double acting engines are employed, which are nevertheless unfurnished with a crank; but engines of this kind are not sufficiently numerous to justify their classification as a distinct species, and, in general, those engines may be considered to be single acting, by which no rotatory motion is imparted.

4. Q.—Is not the circular motion derived from a cylinder engine very irregular, in consequence of the unequal leverage of the crank at the different parts of its revolution?

A.—No ; rotative engines are generally provided with a fly-wheel to correct such irregularities by its momentum ; but where two engines with their respective cranks set at right angles are employed, the irregularity of one engine corrects that of the other with sufficient exactitude for many purposes. In the case of marine and locomotive engines, a fly-wheel is not employed ; but for cotton spinning, and other purposes requiring great regularity of motion, its use with common engines is indispensable, though it is not impossible to supersede the necessity by new contrivances.

5. *Q.*—You implied that there is some other difference between single acting and double acting engines, than that which lies in the use or exclusion of the crank ?

A.—Yes ; single acting engines act only in one way by the force of the steam, and are returned by a counter-weight ; whereas double acting engines are urged by the steam in both directions. Engines, as I have already said, are sometimes made double acting, though unprovided with a crank ; and there would be no difficulty in so arranging the valves of all ordinary pumping engines, as to admit of this action ; for the pumps might be contrived to raise water both by the upward and downward stroke, as indeed in some mines is already done. But engines without a crank are almost always made single acting, perhaps from the effect of custom, as much as from any other reason, and are usually spoken of as such, though it is necessary to know that there are some deviations from the usual practice.

NATURE AND USES OF A VACUUM.

6. *Q.*—The pressure of a vacuum you have stated is nothing; but how can the pressure of a vacuum be said to be nothing, when a vacuum occasions a pressure of 15lbs. on the square inch?

A.—Because it is not the vacuum which exerts this pressure, but the atmosphere, which, like a head of water, presses on every thing immersed beneath it. A head of water, however, would not press down a piston, if the water were admitted on both of its sides; for an equilibrium would then be established, just as in the case of a balance which retains its equilibrium when an equal weight is added to each scale; but take the weight out of one scale, or empty the water from one side of the piston, and motion or pressure is produced; and in like manner pressure is produced on a piston by admitting steam or air upon the one side, and withdrawing the steam or air from the other side. It is not, therefore, to a vacuum, but rather to the existence of an unbalanced plenum, that the pressure made manifest by exhaustion is due, and it is obvious therefore that a vacuum of itself would not work an engine.

7. *Q.*—How is the vacuum maintained in a condensing engine?

A.—The steam, after having performed its office in the cylinder, is permitted to pass into a vessel called the condenser, where a shower of cold water is discharged upon it. The steam is condensed by the cold water, and falls in the form of hot water to the bottom

of the condenser. The water, which would else be accumulated in the condenser, is continually being pumped out by a pump worked by the engine. This pump is called the air pump, because it also discharges any air which may have entered with the water.

8. *Q.*—If a vacuum be an empty space, and there be water in the condenser, how can there be a vacuum there?

A.—There is a vacuum above the water, the water being only like so much iron or lead lying at the bottom.

9. *Q.*—Is the vacuum in the condenser a perfect vacuum?

A.—Not quite perfect; for the cold water entering for the purpose of condensation, is heated by the steam, and emits a vapour of a tension represented by about three inches of mercury; that is, when the common barometer stands at 30 inches, a barometer, with the space above the mercury communicating with the condenser, will stand at about 27 inches.

10. *Q.*—Is this imperfection of the vacuum wholly attributable to the vapour in the condenser?

A.—No: it is partly attributable to the presence of a small quantity of air which enters with the water, and which would accumulate until it destroyed the vacuum altogether but for the action of the air pump, which expels it with the water, as already explained. All common water contains a certain quantity of air in solution, and this air recovers its elasticity when the pressure of the atmosphere is taken off, just as the gas in soda water flies up so soon as the cork of the bottle is withdrawn.

11. Q.—Is a barometer sometimes applied to the condensers of steam engines?

A.—Yes; and it is called the vacuum gauge, because it shows the degree of perfection the vacuum has attained. Another gauge, called the steam gauge, is applied to the boiler, which indicates the pressure of the steam by the height to which the steam forces mercury up a tube. Gauges are also applied to the boiler to indicate the height of the water within it so that it may not be burned out by the water becoming accidentally too low. In some cases a succession of cocks placed a short distance above one another are employed for this purpose, and in other cases a glass tube is placed perpendicularly in the front of the boiler and communicating at each end with its interior. The water rises in this tube to the same height as in the boiler itself and thus shows the actual water level. In most of the modern boilers both of these contrivances are adopted.

12. Q.—Can a condensing engine be worked with a pressure less than that of the atmosphere?

A.—Yes, if once it be started; but it will be a difficult thing to start an engine, if the pressure of the steam be not greater than that of the atmosphere. Before an engine can be started, it has to be blown through with steam to displace the air within it, and this cannot be effectually done if the pressure of the steam be very low. After the engine is started, however, the pressure in the boiler may be lowered, if the engine be lightly loaded, until there is a partial vacuum in the boiler. Such a practice, however, is not to be commended, as the gauge cocks become useless when there is a partial

vacuum in the boiler; inasmuch as, when they are opened, the water will not rush out, but air will rush in. It is impossible, also, under such circumstances, to blow out any of the sediment collected within the boiler, which, in the case of the boilers of steam vessels, requires to be done every two hours or oftener. This is accomplished by opening a large cock which permits some of the supersalted water to be forced overboard by the pressure of the steam. In some cases, in which the boiler applied to an engine is of inadequate size, the pressure within the boiler will fall spontaneously to a point considerably beneath the pressure of the atmosphere; but it is preferable, in such cases, partially to close the throttle valve in the steam pipe, whereby the issue of steam to the engine is diminished; and the pressure in the boiler is thus maintained, while the cylinder receives its former supply.

13. *Q.*—If a hole be opened into a condenser of a steam engine, will air rush into it?

A.—If the hole communicates with the atmosphere the air will be drawn in.

14. *Q.*—With what velocity does air rush into a vacuum?

A.—With the velocity which a body would acquire by falling from the height of a homogeneous atmosphere, which is an atmosphere of the same density throughout as at the earth's surface; and although such an atmosphere does not exist in nature, its existence is supposed, in order to facilitate the computation. It is well known that the velocity with which water issues from a cistern is the same that would be

acquired by a body falling from the level of the head to the level of the issuing point ; which indeed is an obvious law, since every particle of water descends and issues by virtue of its gravity, and is in its descent subject to the ordinary laws of falling bodies. Air rushing into a vacuum is only another example of the same general principle: the velocity of each particle will be that due to the height of the column of air which would produce the pressure sustained ; and the weight of air being known, as well as the pressure it exerts on the earth's surface, it becomes easy to tell what height a column of air, an inch square, and of the atmospheric density, would require to be, to weigh 15lbs. The height would be 27,818 feet, and the velocity which the fall of a body from such a height produces would be 1338 feet per second.

VELOCITY OF FALLING BODIES AND MOMENTUM OF MOVING BODIES.

15. Q.—How do you determine the velocity of falling bodies of different kinds ?

A.—All bodies fall with the same velocity, when there is no resistance from the atmosphere, as is shown by the experiment of letting fall, from the top of a tall exhausted receiver, a feather and a guinea, which reach the bottom at the same time. The velocity of falling bodies is one that is accelerated uniformly, according to a known law. When the height from which a body falls is given, the velocity acquired at the end of the descent can be easily computed. It has been

found by experiment that the square root of the height in feet multiplied by 8.021 will give the velocity.

16. Q.—But the velocity in what terms?

A.—In feet per second. The distance through which a body falls by gravity in one second is $16\frac{1}{2}$ feet, in two seconds $64\frac{4}{2}$ feet, in three seconds, $144\frac{9}{2}$ feet, in four seconds, $257\frac{4}{2}$ feet, and so on. If the number of feet fallen through in one second be taken as unity, then the relation of the times to the spaces will be as follows:—

Number of seconds	1	2	3	4	5	6	&c.,
Units of space passed through	1	4	9	16	25	36	

so that it appears that the spaces passed through by a falling body are as the squares of the times of falling.

17. Q.—Is not the urging force which causes bodies to fall the force of gravity?

A.—Yes; the force of gravity or the attraction of the earth.

18. Q.—And is not that a uniform force, or a force acting with a uniform pressure?

A.—It is.

19. Q.—Therefore during the first second of falling as much impelling pressure will be given by the force of gravity as during every succeeding second?

A.—Undoubtedly.

20. Q.—How comes it then that while the body falls $64\frac{4}{2}$ feet in two seconds, it falls only $16\frac{1}{2}$ feet in one second; or why, since it falls only $16\frac{1}{2}$ feet in one second, should it fall more than twice $16\frac{1}{2}$ feet in two?

A.—Because $16\frac{1}{2}$ feet is the average and not the maximum velocity during the first second. The velocity acquired *at the end* of the 1st second is not $16\frac{1}{2}$ but $32\frac{1}{2}$ feet per second, and at the end of the 2nd second a velocity of $32\frac{1}{2}$ feet has to be added; so that the total velocity at the end of the 2nd second becomes $64\frac{1}{2}$ feet; at the end of the 3rd, the velocity becomes $96\frac{3}{8}$ feet, at the end of the 4th, $128\frac{1}{2}$ feet, and so on. These numbers proceed in the progression 1, 2, 3, 4, &c., so that it appears that the velocities acquired by a falling body at different points, are simply as the times of falling, or the velocity is simply proportionate to the time during which the force of gravity acts. But if the velocities be as the times, and the total space passed through be as the squares of the times, then the total space passed through must be as the squares of the velocity; and as the power inherent in a falling body, of any given weight, is measurable by the height through which it descends, it follows that the power inherent in a moving body of any weight, or the *vis viva* as it is sometimes called, is proportionate to the square of the velocity. Of two balls therefore, of equal weight, but one moving twice as fast as the other, the faster ball has four times the mechanical force accumulated in it that the slower ball has. If the speed of a fly-wheel be doubled, it has four times the *vis viva* it possessed before—*vis viva* being measurable by a reference to the height through which a body must have fallen, to acquire the velocity given.

21. Q.—By what considerations is the *vis viva* or

mechanical energy proper for the fly-wheel of an engine determined?

A.—By a reference to the power produced every half stroke of the engine, joined to the consideration of what relation the energy of the fly-wheel rim must have thereto, to keep the irregularities of motion within the limits which are admissible. It is found in practice, that when the power resident in the fly wheel rim, when the engine moves at its average speed, is from two and a-half to four times greater than the power generated by the engine in one half-stroke—the variation depending on the energy inherent in the machinery the engine has to drive and the equability of motion required—the engine will work with sufficient regularity for most ordinary purposes, but where great equability of motion is required, it will be advisable to make the power resident in the fly-wheel equal to six times the power generated by the engine in one half-stroke.

22. *Q.*—Can you give a practical rule for determining the proper quantity of cast iron for the rim of a fly-wheel in ordinary land engines?

A.—One rule frequently adopted is as follows; Multiply the mean diameter of the rim by the number of its revolutions per minute, and square the product for a divisor; divide the number of actual horse power of the engine by the number of strokes the piston makes per minute, multiply the quotient by the constant number 2,760,000, and divide the product by the divisor found as above; the quotient is the requisite quantity of cast iron in cubic feet to form the fly-wheel rim.

23. Q.—What is Boulton and Watt's rule for finding the dimensions of the fly-wheel?

A.—Boulton and Watt's rule for finding the dimensions of the fly-wheel is as follows:—Multiply 44,000 times the length of the stroke in feet by the square of the diameter of the cylinder in inches, and divide the product by the square of the number of revolutions per minute multiplied by the cube of the diameter of the fly-wheel in feet. The resulting number will be the sectional area of the rim of the fly-wheel in square inches.

CENTRAL FORCES.

24. Q.—What do you understand by centrifugal and centripetal forces?

A.—By centrifugal force, I understand the force with which a revolving body tends to fly from the centre; and by centripetal force, I understand any force which draws it to the centre, or counteracts the centrifugal tendency. In the conical pendulum, or steam engine governor, which consists of two metal balls suspended on rods hung from the end of a vertical revolving shaft, the centrifugal force is manifested by the divergence of the balls, when the shaft is put into revolution; and the centripetal force, which in this instance is gravity, predominates so soon as the velocity is arrested; for the arms then collapse and hang by the side of the shaft.

25. Q.—What measures are there of the centrifugal force of bodies revolving in a circle?

A.—The centrifugal force of bodies revolving in a

circle increases as the diameter of the circle, if the number of revolutions remain the same. If there be two fly-wheels of the same weight, and making the same number of revolutions per minute, but the diameter of one be double that of the other, the larger will have double the amount of centrifugal force. The centrifugal force of the *same wheel*, however, increases as the square of the velocity; so that if the velocity of a fly-wheel be doubled, it will have four times the amount of centrifugal force.

26. Q.—Can you give a rule for determining the centrifugal force of a body of a given weight moving with a given velocity in a circle of a given diameter?

A.—Yes. If the velocity in feet per second be divided by 4.01, the square of the quotient will be four times the height in feet from which a body must have fallen to have acquired that velocity. Divide this quadruple height by the diameter of the circle, and the quotient is the centrifugal force in terms of the weight of the body, so that, multiplying the quotient by the actual weight of the body, we have the centrifugal force in pounds or tons. Another rule is to multiply the square of the number of revolutions per minute by the diameter of the circle in feet, and to divide the product by 5,870. The quotient is the centrifugal force in terms of the weight of the body.

27. Q.—How do you find the velocity of the body when its centrifugal force and the diameter of the circle in which it moves are given?

A.—Multiply the centrifugal force in terms of the weight of the body by the diameter of the circle in feet, and multiply the square root of the product by

4.01; the result will be the velocity of the body in feet per second.

28. Q.—Will you illustrate this by finding the velocity at which the cast iron rim of a fly-wheel 10 feet in diameter would burst asunder by its centrifugal force?

A.—If we take the tensile strength of cast iron at 15,000 lbs. per square inch, a fly-wheel rim of one square inch of sectional area would sustain 30,000 lbs. If we suppose one half of the rim to be so fixed to the shaft as to be incapable of detachment, then the centrifugal force of the other half of the rim at the moment of rupture must be equal to 30,000 lbs. Now 30,000 lbs. divided by 49.48 (the weight of the half rim) is equal to 606.3, which is the centrifugal force in terms of the weight. Then by the rule given in the last answer $606.3 \times 10 = 6063$, the square root of which is 78 nearly, and $78 \times 4.01 = 312.78$, the velocity of the rim in feet per second at the moment of rupture.

29. Q.—What is the greatest velocity at which it is safe to drive a cast iron fly-wheel.

A.—If we take 2,000 lbs. as the utmost strain per square inch to which cast iron can be permanently subjected with safety; then, by a similar process to that just explained, we have $4,000 \text{ lbs.} \div 49.48 = 80.8$ which multiplied by 10 = 808, the square root of which is 28.4, and $28.4 \times 4.01 = 113.884$, the velocity of the rim in feet per second, which may be considered as the highest consistent with safety. Indeed, this limit should not be approached in practice on account of the risks of fracture from weakness or imperfections in the metal.

30. Q.—What is the velocity at which the wheels

of railway trains may run if we take 4,000 lbs. per square inch as the greatest strain to which malleable iron should be subjected?

A.—The weight of a malleable iron rim of one square inch sectional area and 7 feet diameter is $21.991 \text{ feet} \times 3.4 \text{ lbs} = 74.76$, one half of which is 37.4 lbs. Then by the same process as before, $8,000 \div 37.4 = 213.9$, the centrifugal force in terms of the weight: 213.9×7 , the diameter of the wheel = 1497.3, the square root of which, $38.3 \times 4.01 = 155.187$ feet per second, the highest velocity of the rims of railway carriage wheels that is consistent with safety. 155.187 feet per second is equivalent to 105.8 miles an hour. As 4,000 lbs. per square inch of sectional area is the utmost strain to which iron should be exposed in machinery, railway wheels can scarcely be considered safe at speed even considerably under 100 miles an hour, unless so constructed that the centrifugal force of the rim will be counteracted, to a material extent, by the centripetal action of the arms. Hooped wheels are very unsafe, unless the hoops are, by some process or other, firmly attached to the arms. It is of no use to increase the dimensions of the rim of a wheel with the view of giving increased strength to counteract the centrifugal force, as every increase in the weight of the rim will increase the centrifugal force in the same proportion.

CENTRES OF GRAVITY, GYRATION, AND OSCILLATION.

31. *Q.*—What do you understand by the centre of gravity of a body?

A.—That point within it, in which the whole of the weight may be supposed to be concentrated, and which continually endeavours to gain the lowest possible position. A body hung in the centre of gravity will remain at rest in any position.

32. *Q.*—What is meant by the centre of gyration?

A.—The centre of gyration is that point in a revolving body in which the whole momentum may be conceived to be concentrated, or in which the whole effect of the momentum resides. If the ball of a governor were to be moved in a straight line, the momentum might be said to be concentrated at the centre of gravity of the ball; but inasmuch as, by its revolution round an axis, the part of the ball furthest removed from the axis moves more quickly than the part nearest to it, the momentum cannot be supposed to be concentrated at the centre of gravity, but at a point further removed from the central shaft, and that point is what is called the centre of gyration.

33. *Q.*—What is the centre of oscillation?

A.—The centre of oscillation is a point in a pendulum or any swinging body, such, that if all the matter of the body were to be collected into that point the velocity of its vibration would remain unaffected. It is in fact the mean distance from the centre of suspension of every atom, in a ratio which happens not to be an arithmetical one. The centre of oscillation is always in a line passing through the centre of suspension, and the centre of gravity.

THE PENDULUM AND GOVERNOR.

84. Q.—By what circumstance is the velocity of vibration of a pendulous body determined?

A.—By the length of the suspending rod only, or, more correctly, by the distance between the centre of suspension and the centre of oscillation. The length of the arc described does not signify, as the times of vibration will be the same, whether the arc be the fourth or the four hundredth of a circle, or at least they will be nearly so, and would be so exactly, if the curve described were a portion of a cycloid. In the pendulums of clocks, therefore, a small arc is preferred, as there is, in that case, no sensible deviation from the cycloidal curve, but in other respects the size of the arc does not signify.

35. Q.—If then the length of a pendulum be given, can the number of vibrations in a given time be determined?

A.—Yes; the time of vibration bears the same relation to the time in which a body would fall through a space equal to half the length of the pendulum, that the circumference of a circle bears to its diameter. The number of vibrations made in a given time by pendulums of different lengths, is inversely as the square roots of their lengths.

36. Q.—Then when the length of the second's pendulum is known, the proper length of a pendulum to make any given number of vibrations in the minute can readily be computed?

A.—Yes; the length of the second's pendulum

being known, the length of another pendulum, required to perform any given number of vibrations in the minute, may be obtained by the following rule: multiply the square root of the given length by 60, and divide the product by the given number of vibrations per minute; the square of the quotient is the length of pendulum required. Thus if the length of a pendulum were required that would make 70 vibrations per minute in the latitude of London, then

$$\sqrt{\frac{39.1393 \times 60}{70}} = 5.363^2 = 28.75 \text{ in.}, \text{ which is the length required.}$$

37. Q.—Can you explain how it comes that the length of a pendulum determines the number of vibrations it makes in a given time?

A.—Because the length of the pendulum determines the steepness of the circle in which the body moves, and it is obvious, that a body will descend more rapidly over a steep inclined plane, or a steep arc of a circle, than over one in which there is but a slight inclination. The impelling force is gravity, which urges the body with a force proportionate to the distance descended, and if the velocity due to the descent of a body through a given height be spread over a great horizontal distance, the speed of the body must be slow in proportion to the greatness of that distance. It is clear, therefore, that as the length of the pendulum determines the steepness of the arc, it must also determine the velocity of vibration.

38. Q.—If the motions of a pendulum be dependent on the speed with which a body falls, then a certain

ratio must subsist between the distance through which a body falls in a second, and the length of the second's pendulum?

A.—And so there is; the length of the second's pendulum at the level of the sea in London, is 39·1393 inches, and it is from the length of the second's pendulum that the space through which a body falls in a second has been determined. As the time in which a pendulum vibrates is to the time in which a heavy body falls through half the length of the pendulum, as the circumference of a circle is to its diameter, and as the height through which a body falls is as the square of the time of falling, it is clear that the height through which a body will fall, during the vibration of a pendulum, is to half the length of the pendulum as the square of the circumference of a circle is to the square of its diameter, namely, as 9·8696 is to 1; or it is to the whole length of the pendulum as the half of this, namely 4·9348, is to 1; and 4·9348 times 39·1393 inches is 16 and 1·12 feet very nearly, which is the space through which a body falls by gravity in a second.

89. *Q.*—Are the motions of the conical pendulum or governor reducible to the same laws which apply to the common pendulum?

A.—Yes; the motion of the conical pendulum may be supposed to be compounded of the motions of two common pendulums, vibrating at right angles to one another, and one revolution of a conical pendulum will be performed in the same time as two vibrations of a common pendulum, of which the length is equal to the

vertical height of the point of suspension above the plane of revolution of the balls.

40. Q.—Is not the conical pendulum or governor of a steam engine driven by the engine?

A.—Yes.

41. Q.—Then will it not be driven round as any other mechanism would be at a speed proportional to that of the engine?

A.—It will.

42. Q.—Then how can the length of the arms affect the time of revolution?

A.—By flying out until they assume a vertical height answering to the velocity with which they rotate round the central axis. As the speed is increased the balls expand, and the height of the cone described by the arms is diminished, until its vertical height is such that a pendulum of that length would perform two vibrations for every revolution of the governor. By the outward motion of the arms, they partially shut off the steam from the engine. If, therefore, a certain expansion of the balls be desired, and a certain length be fixed upon for the arms, so that the vertical height of the cone is fixed, then the speed of the governor must be such, that it will make half the number of revolutions in a given time that a pendulum equal in length to the height of the cone would make of vibrations. The rule is, multiply the square root of the height of the cone in inches by 0.31986, and the product will be the right time of revolution in seconds. If the number of revolutions and the length of the arms be fixed, and it is wanted to know what is the diameter of the circle described by

the balls, you must divide the constant number 187.58 by the number of revolutions per minute, and the square of the quotient will be the vertical height in inches of the centre of suspension above the plane of the balls' revolution. Deduct the square of the vertical height in inches from the square of the length of the arm in inches, and twice the square root of the remainder is the diameter of the circle in which the centres of the balls revolve.

43. Q.—Cannot the operation of a governor be deduced merely from the consideration of centrifugal and centripetal forces?

A.—It can, and by a very simple process. The horizontal distance of the arm from the spindle divided by the vertical height, will give the amount of centripetal force, and the velocity of revolution requisite to produce an equivalent centrifugal force may be found by multiplying the centripetal force of the ball in terms of its own weight by 70,440, and dividing the product by the diameter of the circle made by the centre of the ball in inches; the square root of the quotient is the number of revolutions per minute. By this rule you fix the length of the arms, and the diameter of the base of the cone, or, what is the same thing, the angle at which it is desired the arms shall revolve, and you then make the speed or number of revolutions such, that the centrifugal force will keep the balls in the desired position.

44. Q.—Does not the weight of the balls affect the question?

A.—Not in the least; each ball may be supposed to be made up of a number of small balls or particles,

and each particle of matter will act for itself. Heavy balls attached to a governor are only requisite to overcome the friction of the throttle valve which shuts off the steam, and of the connections leading thereto. Though the weight of a ball increases its centripetal force, it increases its centrifugal force in the same proportion.

THE MECHANICAL POWERS.

45. Q.—What do you understand by the mechanical powers?

A.—The mechanical powers are certain contrivances, such as the wedge, the screw, the inclined plane, and other elementary machines, which convert a small force acting through a great space into a great force acting through a small space. In the school treatises on mechanics, a certain number of these devices are set forth as the mechanical powers, and each separate device is treated as if it involved a separate principle; but not a tithe of the contrivances which accomplish the stipulated end are represented in these learned works, and there is no very obvious necessity for considering the principle of each contrivance separately when the principles of all are one and the same. Every pressure acting with a certain velocity, or through a certain space, is convertible into a greater pressure acting with a less velocity, or through a smaller space; but the quantity of mechanical force remains unchanged by this transformation, and all that the implements called mechanical powers accomplish is to effect this transformation.

46. Q.—Is there no power gained by the lever?

A.—Not any: the power is merely put into another shape, just as the contents of a hogshead of porter are the same, whether they be let off by an inch tap or by a hole a foot in diameter. There is a greater gush in the one case than the other, but it will last a shorter time; when a lever is used there is a greater force exerted, but it acts through a shorter distance. It requires just the same expenditure of mechanical power to lift 1 lb. through 100 ft., as to lift 100 lbs. through 1 foot. A cylinder of a given cubical capacity will exert the same power by each stroke, whether the cylinder be made tall and narrow, or short and wide; but in the one case it will raise a small weight through a great height, and in the other case, a great weight through a small height.

47. Q.—Is there no loss of power by the use of the crank?

A.—Not any. Many persons have supposed that there was a loss of power by the use of the crank, because at the top and bottom centres it is capable of exerting little or no power; but at those times there is little or no steam consumed, so that no waste of power is occasioned by the peculiarity. Those who imagine that there is a loss of power caused by the crank perplex themselves by confounding the vertical with the circumferential velocity. If the circle of the crank be divided by any number of equidistant horizontal lines, it will be obvious that there must be the same steam consumed, and the same power expended, when the crank pin passes from the level of one line to the level of the other, in whatever part of

the circle it may be, those lines being indicative of equal ascents or descents of the piston. But it will be seen that the circumferential velocity is greater with the same expenditure of steam when the crank pin approaches the top and bottom centres; and this increased velocity exactly compensates for the diminished leverage, so that there is the same power given out by the crank in each of the divisions.

48. Q.—Have no plans been projected for gaining power by means of a lever?

A.—Yes, many plans,—some of them displaying much ingenuity, but all displaying a complete ignorance of the first principles of mechanics, which teach that power cannot be gained by any multiplication of levers and wheels. I have occasionally heard persons say: “You gain a great deal of power by the use of a capstan; why not apply the same resource in the case of a steam vessel, and increase the power of your engine by placing a capstan motion between the engine and paddle wheels?” Others I have heard say: “By the hydraulic press you can obtain unlimited power; why not then interpose a hydraulic press between the engines and the paddles?” To these questions the reply is sufficiently obvious. Whatever you gain in force you lose in velocity; and it would benefit you little to make the paddles revolve with ten times the force, if you at the same time caused them to make only a tenth of the number of revolutions. You cannot, by any combination of mechanism, get increased force and increased speed at the same time, or increased force without diminished speed: and it is from the ig-

norance of this inexorable condition, that such myriads of schemes for the realisation of perpetual motion, by combinations of levers, weights, wheels, quicksilver, cranks, and other mere pieces of inert matter, have been propounded.

49. Q.—Then a force once called into existence cannot be destroyed?

A.—No; force is eternal, if by force you mean power, or in other words pressure acting through space. But if by force you mean mere pressure, then it furnishes no measure of power. Power is not measurable by force, but by force and velocity combined.

50. Q.—Is not power lost when two moving bodies strike one another and come to a state of rest?

A.—No, not even then. The bodies if elastic will rebound from one another with their original velocity; if not elastic they will sustain an alteration of form, and heat or electricity will be generated of equivalent value to the power which has disappeared.

51. Q.—Then if mechanical power cannot be lost, and is being daily called into existence must not there be a daily increase in the power existing in the world?

A.—That appears probable unless it flows back in the shape of heat or electricity to the celestial spaces. The source of mechanical power is the sun which exhales vapours that descend in rain, to turn mills, or which causes winds to blow by the unequal rarefaction of the atmosphere. It is from the sun too that the power comes which is liberated in a steam engine. The solar rays enable plants to decompose carbonic acid gas, the product of combustion, and the vegetation thus rendered possible is the source of coal and other

combustible bodies. The combustion of coal under a steam boiler therefore merely liberates the power which the sun gave out thousands of years before.

FRICTION.

52. Q.—What is friction?

A.—Friction is the resistance experienced when one body is rubbed upon another body, and is supposed to be the result of the natural attraction which bodies have for one another, and of the interlocking of the impalpable asperities upon the surfaces of all bodies, and these combined agencies produce such internal motions among the particles of a rubbing surface as to generate heat, which heat will always be of equivalent value to the power expended in overcoming the friction. It is found that as much power is expended in heating a pound of water one degree by friction, as would raise a pound weight 772 feet high; and this measure of power is consequently termed the *mechanical equivalent* of the heat. The friction of smooth rubbing substances is less when the composition of those substances is different, than when it is the same, the particles being supposed to interlock less when the opposite prominences or asperities are not coincident.

53. Q.—Does friction increase with the extent of rubbing surface?

A.—No; the friction, so long as there is no violent heating or abrasion, is simply in the proportion of the pressure keeping the surfaces together, or nearly so. It is, therefore, an obvious advantage to have the

bearing surfaces of steam engines as large as possible, as there is no increase of friction by extending the surface, while there is a great increase in the durability. When the bearings of an engine are made too small, they very soon wear out.

54. Q.—Does friction increase in the same ratio as velocity?

A.—No; friction does not increase with the velocity at all, if the friction over a given amount of surface be considered;* but it increases as the velocity, if the comparison be made with the time during which the friction acts. Thus the friction of each stroke of a piston is the same, whether it makes 20 strokes in the minute, or 40: in the latter case, however, there are twice the number of strokes made, so that, though the friction per stroke is the same, the friction per minute is doubled. The friction, therefore, of any machine per hour varies as the velocity, though the friction per revolution remains, at all ordinary velocities, the same. Of excessive velocities we have not sufficient experience to enable us to state with confidence whether the same law continues to operate among them.

55. Q.—Can you give any approximate statement of the force expended in overcoming friction?

A.—It varies with the nature of the rubbing bodies. The friction of iron sliding upon iron, has generally been taken at about one-tenth of the pressure, when the surfaces are oiled and then wiped again, so that no film of oil is interposed. The friction of iron rub-

* This statement refers only to the friction of solids, and not of liquids, which comes under a different law, as explained at page 361.

bing upon brass has generally been taken at about one-eleventh of the pressure under the same circumstances; but in machines in actual operation, where a film of some lubricating material is interposed between the rubbing surfaces, it is not more than one-third of this amount or $\frac{1}{3}$ rd of the weight. While this, however, is the average result, the friction is a good deal less in some cases. Mr. Southern, in some experiments upon the friction of the axle of a grindstone—an account of which may be found in the 65th volume of the Philosophical Transactions—found the friction to amount to less than $\frac{1}{10}$ th of the weight; and Mr. Wood, in some experiments upon the friction of locomotive axles, found that by ample lubrication the friction might be made as little as $\frac{1}{10}$ th of the weight. In some experiments upon the friction of shafts by Mr. G. Rennie, he found that with a pressure of from 1 to 5 cwt. the friction did not exceed $\frac{1}{9}$ th of the pressure when tallow was the unguent employed; with soft soap it became $\frac{1}{4}$ th. The fact appears to be that the amount of the resistance denominated friction depends, in a great measure, upon the nature of the unguent employed, and in certain cases the viscosity of the unguent may occasion a greater retardation than the resistance caused by the attrition. In watchwork therefore, and other fine mechanism it is necessary both to keep the bearing surfaces small, and to employ a thin and limpid oil for the purpose of lubrication, for the resistance caused by the viscosity of the unguent increases with the amount of surface, and the amount of surface is relatively greater in the smaller class of works.

56. Q.—Is a very thin unguent preferable also for the larger class of bearings ?

A.—The nature of the unguent, proper for different bearings, appears to depend in a great measure upon the amount of the pressure to which the bearings are subjected,—the hardest unguents being best where the pressure is greatest. The function of lubricating substances is to prevent the rubbing surfaces from coming into contact, whereby abrasion would be produced, and unguents are effectual in this respect in the proportion of their viscosity ; but if the viscosity of the unguent be greater than what suffices to keep the surfaces asunder, an additional resistance will be occasioned ; and the nature of the unguent selected should always have reference, therefore, to the size of the rubbing surfaces, or to the pressure per square inch upon them. . With oil the friction appears to be a minimum when the pressure on the surface of a bearing is about 90 lbs. per square inch. The friction from too small a surface increases twice as rapidly as the friction from too large a surface, added to which, the bearing, when the surface is too small, wears rapidly away.

57. Q.—Has not M. Morin, in France, made some very complete experiments to determine the friction of surfaces of different kinds sliding upon one another ?

A.—He has ; but the result does not differ materially from what is stated above, though, upon the whole, M. Morin found the resistance due to friction to be somewhat greater than it has been found to be by various other engineers. When the surfaces were

merely wiped with a greasy cloth, but had no film of lubricating material interposed, the friction of brass upon cast iron he found to be $\cdot 107$, or about $\frac{1}{10}$ th of the load, which was also the friction of cast iron upon oak. But when a film of lubricating material was interposed, he found that the friction was the same whether the surfaces were wood on metal, wood on wood, metal on wood, or metal on metal; and the amount of the friction in such case depended chiefly on the nature of the unguent. With a mixture of hogs' lard and olive oil interposed between the surfaces, the friction was usually from $\frac{1}{12}$ th to $\frac{1}{14}$ th of the load, but in some cases it was only $\frac{1}{10}$ th of the load.

58. Q.—May water be made to serve for purposes of lubrication?

A.—Yes, water will answer very well if the surface be very large relatively with the pressure; and in screw vessels where the propeller shaft passes through a long pipe at the stern, the stuffing box is purposely made a little leaky. The small leakage of water into the vessel which is thus occasioned, keeps the screw shaft in this situation always wet, and this is all the lubrication which this bearing requires or obtains.

59. Q.—What is the utmost pressure which may be employed without heating when oil is the lubricating material?

A.—That will depend upon the velocity. When the pressure exceeds 800 lbs. per square inch, however, upon the section of the bearing in a direction parallel with the axis, then the oil will be forced out and the bearing will necessarily heat.

60. Q.—But, with a given velocity, can you tell the limit of pressure which will be safe in practice or with a given pressure can you tell the limit of velocity?

A.—Yes that may be done by the following empirical rule which has been derived from observations made upon bearings of different sizes and moving with different velocities. Divide the number 70,000 by the velocity of the surface of the bearing in feet per minute. The quotient will be the number of pounds per square inch of section in the line of the axis that may be put upon the bearing. Or, if we divide 70,000 by the number of pounds per square inch of section, then the quotient will be the velocity in feet per minute at which the circumference of the bearing may work.

61. Q.—The number of square inches upon which the pressure is reckoned, is not the circumference of the bearing multiplied by its length but the diameter of the bearing multiplied by its length?

A.—Precisely so, it will be the diameter multiplied by the length of the bearing.

62. Q.—What is the amount of friction in the case of surfaces sliding upon one another in sandy or muddy water—such surfaces, for example, as are to be found in the sluices of valves for water?

A.—Various experiments have been made by Mr. Summers of Southampton to ascertain the friction of brass surfaces sliding upon each other in salt-water, with the view of finding the power required for moving sluice doors for lock-gates and for other similar purposes. The surfaces were planed as true and smooth

as the planing machine would make them, but were *not* filed or scraped, and the result was as follows:—

Area of Slide rubbing Surface.	Weight or Pressure on rubbing Surface.	Power required to move the Slide <i>slowly</i> in muddy Salt Water, kept stirred up.
Sq. in. 8	lb. 56	lb. 21·5
"	112	44·
"	168	65·5
"	224	88·5
"	336	140·5
"	448	170·75

Fig. 1.

Sketch of Slide.

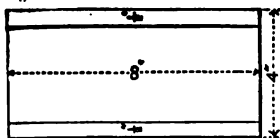

Fig. 2.



The facing on which the slide moved was similar, but three or four times as long.

These results were the average of eight fair trials: in each case, the sliding surfaces were totally immersed in muddy salt-water, and although the apparatus used for drawing the slide along was not very delicately fitted up, the power required may be considered as a sufficient approximation for practical purposes.

It appears from these experiments, that rough surfaces follow the same law as regards friction that is followed by smooth, for in each case the friction increases directly as the pressure.

STRENGTH OF MATERIALS AND STRAINS SUBSISTING
IN MACHINES.

63. *Q.* — In what way are the strengths of the different parts of a steam engine determined?

A. — By reference to the amount of the strain or pressure to which they are subjected, and to the cohesive strength of the iron or other material of which they are composed. The strains subsisting in engines are usually characterised as tensile, crushing, twisting, breaking, and shearing strains; but they may be all resolved into strains of extension and strains of compression; and by the power of the materials to resist these two strains, will their practical strength be measurable.

64. *Q.* — What are the ultimate strengths of the malleable and cast iron, brass, and other materials employed in the construction of engines?

A. — The tensile and crushing strengths of any given material are by no means the same. The tensile strength, or strength when extended, of good bar iron is about 60,000 lbs., or nearly 27 tons per square inch of section; and the tensile strength of cast iron is about 15,000 lbs., or say $6\frac{3}{4}$ to 7 tons per square inch of section. These are the weights which are required to break them. The crushing strain of cast iron, however, is about 100,000 lbs., or $44\frac{1}{2}$ tons; whereas the crushing strength of malleable iron is not more than 27,000 lbs., or 12 tons, per square inch of section, and indeed it is generally less than this. The ultimate tensile strength, therefore, of malleable iron is

four times greater than that of cast iron, but the crushing strength of cast iron is between three and four times greater than that of wrought iron. It may be stated, in round numbers, that the tensile strength of malleable iron is twice greater than its crushing strength; or, in other words, that it will take twice the strain to break a bar of malleable iron by drawing it asunder endways, than will cripple it by forcing it together endways like a pillar; whereas a bar of cast iron will be drawn asunder with one sixth of the force that will be required to break or cripple it when forced together endways like a pillar.

65. Q.— What is the cohesive strength of steel?

A.— The ultimate tensile strength of good cast or blistered steel is about twice as great as that of wrought iron, being about 130,000 lbs. per square inch of section. The tensile strength of gun metal, such as is used in engines, is about 86,000 lbs. per square inch of section; of wrought copper about 33,000 lbs.; and of cast copper about 19,000 lbs. per square inch of section.

66. Q.— Is the crushing strength of steel greater or less than its tensile strength?

A.— It is about twice greater. A good steel punch will punch through a plate of wrought iron of a thickness equal to the diameter of the punch. A punch therefore of an inch diameter will pierce a plate an inch thick. Now it is well known, that the strain required to punch a piece of metal out of a plate, is just the same as that required to tear asunder a bar of iron of the same area of cross section as the area of the surface cut. The area of the surface cut in this

case will be the circumference of the punch, 3.1416 inches, multiplied by the thickness of the plate, 1 inch, which makes the area of the cut surface 3.1416 square inches. The area of the point of the punch subjected to the pressure is .7854 square inches, so that the area cut to the area crushed is as four to one. In other words, it will require four times the strain to crush steel that is required to tear asunder malleable iron, or it will take about twice the strain to crush steel that it will require to break it by extension.

67. Q. — What strain may be applied to malleable iron in practice ?

A. — A bar of wrought iron to which a tensile or compressing strain is applied, is elongated or contracted like a very stiff spiral spring, nearly in the proportion of the amount of strain applied up to the limit at which the strength begins to give way, and within this limit it will recover its original dimensions when the strain is removed. If, however, the strain be carried beyond this limit, the bar will not recover its original dimensions, but will be permanently pulled out or pushed in, just as would happen to a spring to which an undue strain had been applied. This limit is what is called the limit of elasticity; and whenever it is exceeded, the bar, though it may not break immediately, will undergo a progressive deterioration, and will break in the course of time. The limit of elasticity of malleable iron when extended, or, in other words, the tensile strain to which a bar of malleable iron an inch square may be subjected without permanently deranging its structure, is usually taken at 17,800 lbs., or from that to 10 tons, depend-

ing on the quality of the iron. It has also been found that malleable iron is extended about one ten thousandth part of its length for every ton of direct strain applied to it.

68. Q.—What is the limit of elasticity of cast iron?

A.—It is commonly taken at 15,300 lbs. per square inch of section; but this is certainly much too high, as it exceeds the tensile strength of irons of medium quality. A bar of cast iron if compressed by weights will be contracted in length twice as much as a bar of malleable iron under similar circumstances; but malleable iron when subjected to a greater strain than 12 tons per square inch of section, gradually crumples up by the mere continuance of the weight. A cast iron bar one inch square and ten feet long, is shortened about one tenth of an inch by a compressing force of 10,000 lbs., whereas a malleable iron bar of the same dimensions would require to shorten it equally a compressing force of 20,000 lbs. As the load, however, approaches 12 tons, the compressions become nearly equal, and above that point the rate of the compression of the malleable iron rapidly increases. A bar of cast iron, when at its breaking point by the application of a tensile strain, is stretched about one six hundredth part of its length; and an equal strain employed to compress it, would shorten it about one eight hundredth part of its length.

69. Q.—But to what strain may the iron used in the construction of engines be safely subjected?

A.—The most of the working parts of modern engines are made of malleable iron and the utmost

strain to which wrought iron should be subjected in machinery is 4000 lbs. per square inch of section. Cast iron should not be subjected to more than half of this. In locomotive boilers the strain of 4000 lbs. per square inch of section is sometimes exceeded by nearly one half; but such an excess of strain approaches the limits of danger.

70. Q.—Will you explain in what way the various strains subsisting in a steam engine may be resolved into tensile and crushing strains; also in what way the magnitude of those strains may be determined?

A.—To take the case of a beam subjected to a transverse strain, such as the great beam of an engine, it is clear, if we suppose the beam broken through the middle, that the amount of strain at the upper and lower edges of the beam, where the whole strain may be supposed to be collected, will, with any given pressure on the piston, depend upon the proportion of the length to the depth of the beam. One edge of the beam breaks by extension, and the other edge by compression; and the upper and lower edges may be regarded as pillars, one of which is extended by the strain, and the other is compressed. If, to make an extreme supposition, the depth of the beam is taken as equal to its length, then the pillars answering to the edges of the beam will be compressed, and extended by what is virtually a bell-crank lever with equal arms; the horizontal distance from the main centre to the end of the beam being one of the arms, and the vertical height from the main centre to the top edge of the beam being the other arm. Tha

distance, therefore, passed through by the fractured edge of the beam during a stroke of the engine, will be equal to the length of the stroke ; and the strain it will have to sustain will consequently be equal to the pressure on the piston. If its motion were only half that of the piston, as would be the case if its depth were made one half less, the strain the beam would have to bear would be twice as great ; and it may be set down as an axiom, that the strain upon any part of a steam engine or other machine is inversely equal to the strain produced by the prime mover, multiplied by the comparative velocity with which the part in question moves. If any part of an engine moves with a less velocity than the piston, it will have a greater strain on it, if resisted, than is thrown upon the piston. If it moves with a greater velocity than the piston, it will have a less strain upon it, and the difference of strain will in every case be in the inverse proportion of the difference of the velocity.

71. *Q.*— Then, in computing the amount of metal necessary to give due strength to a beam, the first point is to determine the velocity with which the edge of the beam moves at that point where the strain is greatest ?

A.— The web of a cast iron beam or girder serves merely to connect the upper and lower edges or flanges rigidly together, so as to enable the extending and compressing strains to be counteracted in an effectual manner by the metal of those flanges. It is only necessary, therefore, to make the flanges of sufficient strength to resist effectually the crushing and tensile strains to which they are exposed, and

to make the web of the beam of sufficient strength to prevent a distortion of its shape from taking place.

72. Q.—Is the strain greater from being moveable or intermittent than if it was stationary?

A. — Yes; it is nearly twice as great from being moveable. Engineers are in the habit of making girders intended to sustain a stationary load, about three times stronger than the breaking weight; but if the load be a moveable one, as is the case in the girders of railway bridges, they make the strength equal to six times the breaking weight.

73. Q.—Then the strain is increased by the suddenness with which it is applied?

A. — If a weight be placed on a long and slender beam propped up in the middle, and the prop be suddenly withdrawn, so as to allow deflection to take place, it is clear that the deflection must be greater than if the load had been gradually applied. The momentum of the weight and also of the beam itself falling through the space through which it has been deflected, has necessarily to be counteracted by the elasticity of the beam; and the beam will, therefore, be momentarily bent to a greater extent than what is due to the load, and after a few vibrations up and down it will finally settle at that point of deflection which the load properly occasions. It is obvious that such a beam must be strong enough, not merely to sustain the pressure due to the load, but also that accession of pressure due to the counteracted momentum of the weight and of the beam itself. Although in steam engines the beam is not loaded by a weight, but by the pressure of the steam yet the

momentum of the beam itself must in every case be counteracted, and the momentum will be considerable in every case in which a large and rapid deflection takes place. A rapid deflection increases the amount of the deflection as well as the amount of the strain, as is seen in the cylinder cover of a Cornish pumping engine, into which the steam is suddenly admitted, and in which the momentum of the particles of the metal put into motion increases the deflection to an extent such as the mere pressure of the steam could not produce.

74. *Q.*—What will be the amount of increased strain consequent upon deflection?

A.—The momentum of any moving body being proportional to the square of its velocity, it follows that the strain will be proportional to the square of the amount of deflection produced in a specified time.

75. *Q.*—But will not the inertia of a beam resist deflection, as well as the momentum increase deflection?

A.—No doubt that will be so; but whether in practical cases increase of mass without reference to strength or load will, upon the whole, increase or diminish deflection, will depend very much upon the magnitude of the mass relatively with the magnitude of the deflecting pressure, and the rapidity with which that pressure is applied and removed. Thus if a force or weight be very suddenly applied to the middle of a ponderous beam, and be as suddenly withdrawn, the inertia of the beam will, as in the case of the collision of bodies, tend to resist the force, and thus obviate deflection to a considerable extent; but

if the pressure be so long continued as to produce the amount of deflection due to the pressure, the effect of the inertia in that case will be to increase the deflection.

76. Q. — Will the pressure given to the beam of an engine in different directions facilitate its fracture?

A. — Iron beams bent alternately in opposite directions, or alternately deflected and released, will be broken in the course of time with a much less strain than is necessary to produce immediate fracture. It has been found, experimentally, that a cast iron bar, deflected by a revolving cam to only half the extent due to its breaking weight, will in no case withstand 900 successive deflections; but, if bent by the cam to only one third of its ultimate deflection, it will withstand 100,000 deflections without visible injury. Looking, however, to the jolts and vibrations to which engines are subject, and the sudden strains sometimes thrown upon them, either from water getting into the cylinder or otherwise, it does not appear that a strength answering to six times the breaking weight will give sufficient margin for safety in the case of cast iron beams.

77. Q. — Does the same law hold in the case of the deflection of malleable iron bars?

A. — In the case of malleable iron bars it has been found that no very perceptible damage was caused by 10,000 deflections, each deflection being such as was due to half the load that produced a large permanent deflection.

78. Q. — The power of a rod or pillar to resist

compression becomes very little when the diameter is small and the length great?

A. — The power of a rod or pillar to resist compression, varies nearly as the fourth power of the diameter divided by the square of the length. In the case of hollow cylindrical columns of cast iron, it has been found, experimentally, that the 3·55th power of the internal diameter, subtracted from the 3·55th power of the external diameter, and divided by the 1·7th power of the length, will represent the strength very nearly. In the case of hollow cylindrical columns of malleable iron, experiment shows that the 3·59th power of the internal diameter, subtracted from the 3·59th power of the external diameter, and divided by the square of the length, gives a proper expression for the strength; but this rule only holds where the strain does not exceed 8 or 9 tons on the square inch of section. Beyond 12 or 13 tons per square inch of section, the metal cannot be depended upon to withstand the strain, though hollow pillars will sometimes bear 15 or 16 tons per square inch of section.

79. *Q.* — Does not the thickness of the metal of the pillars or tubes affect the question?

A. — It manifestly does; for a tube of very thin metal, such as gold leaf or tin foil, would not stand on end at all, being crushed down by its own weight. It is found, experimentally, that in malleable iron tubes of the respective thicknesses of ·525, ·272, and ·124 inches, the resistances per square inch of section are 19·17, 14·47, and 7·47 tons respectively. The power of plates to resist compression varies nearly as

the cube, or more nearly as the 2·878th power of their thickness; but this law only holds so long as the pressure applied does not exceed from 9 to 12 tons per square inch of section. When the pressure is greater than this the metal is crushed, and a new law supervenes, according to which it is necessary to employ plates of twice or three times the thickness, to obtain twice the resisting power.

80. Q.—In a riveted tube, will the riveting be much damaged by heavy strains?

A.—It will be most affected by percussion. Long continued impact on the side of a tube, producing a deflection of only one fifth of that which would be required to injure it by pressure, is found to be destructive of the riveting; but in large riveted structures, such as a ship or a railway bridge, the inertia of the mass will, by resisting the effect of impact, prevent any injurious action from this cause from taking place.

81. Q.—Will the power of iron to resist shocks be in all cases proportional to its power to resist strains?

A.—By no means. Some cast iron is very hard and brittle; and although it will in this state resist compression very strongly, it will be easily broken by a blow. Iron which has been re-melted many times generally falls into this category, as it will also do if run into very small castings. It has been found, by experiment, that iron of which the crushing strength per square inch is about 42 tons, will, if re-melted twelve times, bear a crushing weight of 70 tons, and if re-melted eighteen times it will

bear a crushing weight of 83 tons ; but taking its power to resist impact in its first state at 706, this power will be raised at the twelfth re-melting to 1153, and will be sunk at the eighteenth re-melting to 149.

82. *Q.*—From all this it appears that a combination of cast iron and malleable iron is the best for the beams of engines?

A.—Yes, and for all beams. Engine beams should be made deeper at the middle than they are now made : the web should be lightened by holes pierced in it, and round the edge of the beam there should be a malleable iron hoop or strap securely attached to the flanges by riveting or otherwise. The flanges at the edges of engine beams are invariably made too small. It is in them that the strength of the beam chiefly resides.

CHAPTER I.

GENERAL DESCRIPTION OF THE STEAM
ENGINE.

THE BOILER.

83. Q. — What are the chief varieties of the steam engine in actual practical use?

A. — There is first the single acting engine, which is used for pumping water ; the rotative land engine, which is employed to drive mills and manufactories ; the rotative marine engine, which is used to propel steam vessels ; and the locomotive engine, which is employed on railways. The last is always a high pressure engine ; the others are, for the most part, condensing engines.

84. Q. — Will you explain the construction and action of the single acting engine, used for draining mines?

A. — Permit me then to begin with the boiler, which is common and necessary to all engines ; and I will take the example of a waggon boiler, such as was employed by Boulton and Watt universally in their early engines, and which is still in extensive use. This boiler is a long rectangular vessel, with a rounded top, like that of a carrier's waggon, from its resemblance to which it derives its name. A fire is set beneath it, and flues constructed of brickwork encircle

it, so as to keep the flame and smoke in contact with the boiler for a sufficient time to absorb the heat.

85. Q. — This species of boiler has not an internal furnace, but is set in brickwork, in which the furnace is formed?

A. — Precisely so. The general arrangement and configuration will be at once understood by a reference to the annexed figure (*fig. 3.*), which is a perspective

Fig. 3.

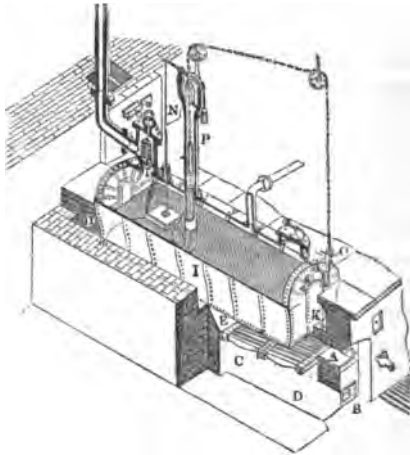

WAGGON BOILER.

view of a wagon boiler. The grate and a part of the flues are rendered visible in the figure by the removal of a portion of the surrounding masonry in which the boiler is set. The interior of the boiler is also shown by cutting off one half of the semicircular roof. The door by which the fuel is in-

troduced to the grate is represented at *A*. A door is also represented at *B*, leading to the ash pit ; but in land boilers doors are not commonly applied in this situation. The fire bars at *C* slope downwards from the front at an angle of about 25° , giving the fuel a tendency to move towards the back of the grate. The ash pit *D* is constructed of sufficient magnitude to enable a sufficient supply of air to ascend through the grate bars, and the flame passes over a low wall or bridge at *E*, and traverses the bottom of the boiler. The smoke rises up at the back of the boiler, and proceeds from *H* to *I*, through the flue shown in that situation, with its upper part removed. It proceeds on in this flue to *K*; passes along the other side of the boiler, and then ascends the chimney. The performance of this course by the smoke is what is termed a wheel draught, as the smoke wheels once round the boiler, and then ascends the chimney.

86. *Q.*—Is the performance of this course by the smoke universal in waggon boilers?

A.—No: such boilers sometimes have what is termed a split draught. The smoke and flame, when they reach the end of the boiler, pass in this case through an iron flue or tube, reaching from end to end of the boiler; and on arriving at the position of *K*, the smoke splits or separates — one half passing through a flue on the one side of the boiler, and the other half passing through a flue on the other side of the boiler—both of these flues having their debouch in the chimney.

87. *Q.*—There appear to be several pipes leading out of the boiler?

A.—On the top of the boiler, near the front, is a

short cylinder, with a lid secured by bolts. This is the man-hole door, the purpose of which is to enable a man to get into the inside of the boiler when necessary for inspection and repair. On the top of this door is a small valve opening downwards, called the atmospheric valve. The intention of this valve is to prevent a vacuum from being formed accidentally in the boiler, which might collapse it; for if the pressure in the boiler subsides to a point materially below the pressure of the atmosphere, the valve will open and allow air to get in. The bent pipe, which rises up from the top of the boiler, immediately behind the position of the man-hole, is the steam pipe for conducting the steam to the engine; and the bent pipe which ascends from the top of the boiler, at the back end, is the waste steam pipe for conducting away the steam, which escapes through the safety valve. This valve is set in a chest, standing on the top of the boiler, at the foot of the waste steam pipe, and it is loaded with iron or leaden weights to a point answerable to the intended pressure of the steam.

88. Q.—How is the proper level of the water in the boiler maintained?

A.—By means of a balanced buoy or float, which in this boiler is square, and which may be seen at the surface of the water. This float is attached to the rod *N*, which in its turn is attached to a lever, set on the top of the large upright pipe *P*. The upper part of the pipe *P* is widened out into a small cistern, through a short pipe in the middle of which a chain passes to the damper; but any water emptied into this small cistern cannot pass into *P*, except through a small valve fixed to the lever to which the rod *N* is

attached. The water for replenishing the boiler is pumped into the small cistern on the top of P; and it follows from these arrangements that when the buoy falls, the rod N opens the small valve and allows the feed water to enter P, which communicates with the water in the boiler; whereas, when the buoy rises, the feed cannot enter P, and it has, therefore, to run to waste through an overflow pipe provided for the purpose.

89. Q. — How is the strength of the fire regulated?

A. — The draught through the furnaces of land boilers is regulated by a plate of metal or a damper, as it is called, which slides like a sluice up and down in the flue, and this damper is closed more or less when the intensity of the fire has to be moderated. In waggon boilers this is generally accomplished by self-acting mechanism. In the pipe P, which is called a stand pipe, the water rises up to a height proportional to the pressure of the steam, and the surface of the water in this pipe will rise or fall with the fluctuations in the pressure of the steam. In this pipe a float is placed, which communicates by means of a chain with the damper at O. If the pressure of the steam rises, the float will be raised and the damper closed, whereas, if the pressure in the boiler falls, the reverse of this action will take place.

90. Q. — Are all land boilers of the same construction as that which you have just described?

A. — No; many land boilers are now made of a cylindrical form, with one or two internal flues in which the furnace is placed. A boiler of this kind is represented in *figs.* 4. and 5., and which is the species

Fig. 4.

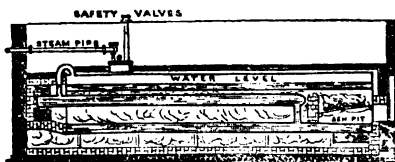

CORNISH BOILER.

Longitudinal Section.

Fig. 5.



Transverse Section.

of boiler principally used in Cornwall. In this boiler a large internal cylinder or flue runs from end to end. In the fore part of this cylinder the furnace is placed, and behind the furnace a large tube filled with water extends to the end of the boiler. This internal tube is connected to the bottom part of the boiler by a copper pipe standing vertically immediately behind the furnace bridge, and to the top part of the boiler by a bent copper pipe which stands in a vertical position near the end of the boiler. The smoke, after passing through the central flue, circulates round the sides and beneath the bottom of the boiler before its final escape into the chimney. The boiler is carefully covered over to prevent the dispersion of the heat.

91. Q. — Will you describe the construction of the boilers used in steam vessels?

A. — These are of two classes, flue boilers and tubular boilers, but the latter are now most used. In the flue boiler the furnaces are set within the boiler, and the flues proceeding from them wind backwards and forwards within the boiler until finally they meet and enter the chimney. *Figs. 6, 7, 8, and 9, are different views of a flue boiler. Fig. 6. is a front eleva-*

tion, showing the mouths of the furnaces and ash-pits. *Fig. 7.* is a horizontal section through *AB*, *fig. 9.* ; and

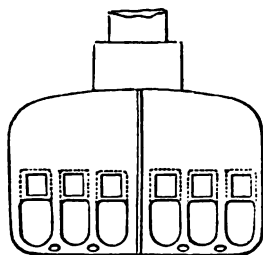
Fig. 6.

MARINE FLUE BOILER.
Elevation.

fig. 8. is a horizontal section through *CD*, *fig. 9.* *Fig. 9.* is a vertical section through *GH*, *fig. 8.* In *fig. 9.* the general configuration of the boiler is very clearly represented ; and the smoke, after winding first through the lower tier of flues and next through the upper tier of flues, finally debouches at the chimney.

92. Q.— Is this arrangement different from that obtaining in tubular boilers?

A.— In tubular boilers, the smoke after leaving

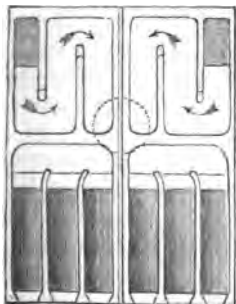
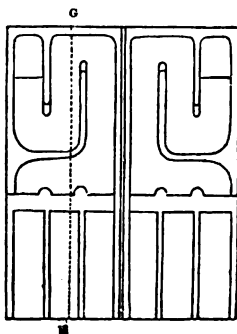
Fig. 7.*Fig. 8.*

MARINE FLUE BOILER.

Horizontal Section through Furnaces.

Horizontal Section through Flues.

Fig. 9.

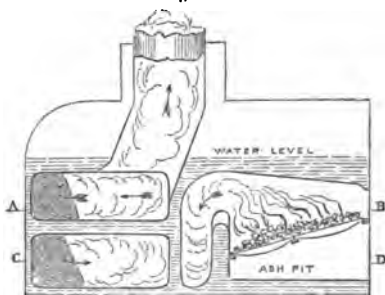

MARINE FLUE BOILER.
Longitudinal Section.

the furnace just passes once through a number of small tubes and then enters the chimney. These tubes are sometimes of brass, and they are usually about 3 inches in diameter and 6 or 7 feet long. *Figs. 10. and 11.* represent a marine tubular boiler: *fig. 10.* being a vertical longitudinal section, and *fig. 11.* being half a front elevation and half a transverse section. There is a projecting part on the top of the boiler called the "steam chest," of which the purpose is to retain for the use of the cylinder a certain supply of steam in a quiescent state, in order that it may have time to clear itself of foam or spray. A steam chest is a usual part of all marine boilers. In *fig. 10.* A is the furnace, B the steam chest, and C the smoke box which opens into the chimney. The front of the smoke box is usually closed by doors which may be opened when necessary to sweep the soot out of the tubes.

Fig. 10.

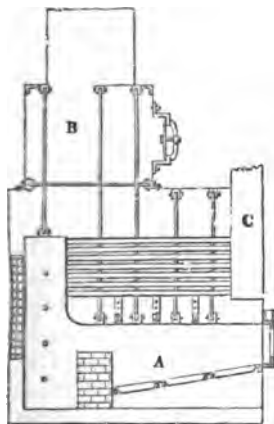
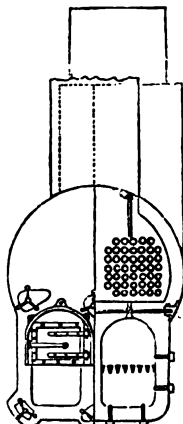

Fig. 11.



TUBULAR MARINE BOILER.

Longitudinal Section.

Half Elevation, Half Section.

THE ENGINE.

93. Q. — The steam passes from the boiler through the steam pipe into the cylinder of the engine?

A. — And presses up and down the piston alternately, being admitted alternately above and below the piston by suitable valves provided for that purpose.

94. Q. — This reciprocating motion is all that is required in a pumping engine?

A. — The prevailing form of the pumping engine consists of a great beam vibrating on a centre like the beam of a pair of scales, and the cylinder is in con-

nection with one end of the beam and the pump stands at the other end. The pump end of the beam is usually loaded, so as to cause it to preponderate when the engine is at rest; and the whole effort of the steam is employed in overcoming this preponderance until a stroke is performed, when, the steam being shut off, the heavy end of the beam again falls and the operation is repeated.

95. Q. — In the double acting engine the piston is pushed by the steam both ways, whereas in the single acting engine it is only pushed one way?

A. — The structure and action of a double acting land engine of the kind introduced by Mr. Watt, will be understood by a reference to the annexed figure (*fig. 12.*), where an engine of this kind is shown in section. *O* is the cylinder in which a movable piston, *P*, is forced alternately up and down by the alternate admission, to each side, of the steam from the boiler. The piston, by means of a rod called the piston rod, gives motion to the beam *Hf*, which by means of a heavy bar, *o*, called the connecting rod, moves the crank, *G*, and with it the fly wheel, *F*, from which the machinery to be driven derives its motion.

96. Q. — Where does the steam enter from the boiler?

A. — At the steam pipe, *s*. The throttle valve in that pipe is an elliptical plate of metal swivelling on a spindle passing through its edge from side to side, and by turning which more or less the opening through the pipe will be more or less closed. The extent to which this valve is opened or closed is determined by the governor, *Q*, the balls of which, as they collapse

Fig. 12.

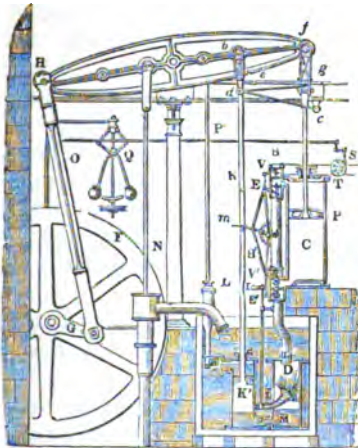

DOUBLE ACTING ROTATIVE STEAM ENGINE.

or expand, move up or down a collar on the governor spindle, which motion is communicated to the throttle valve by suitable rods and bell-cranks. The governor, it will be seen, consists substantially of two heavy balls attached to arms fixed upon an upright shaft, which is kept in revolution by means of a cord driven by a pulley on the fly wheel shaft. The velocity with which the balls of the governor revolve being proportional to that of the fly wheel, it will follow, that if by reason of too rapid a supply of steam, an undue speed be given to the fly wheel, and therefore to the balls, a divergence of the balls will take place to an extent corresponding to the excess of velocity, and

this movement being communicated to the throttle valve it will be partly closed, the supply of steam to the engine will be diminished, and the velocity of its motion will be reduced. If, on the other hand, the motion of the engine is slower than is requisite, owing to a deficient supply of steam through *s*, then the balls, not being sufficiently affected by centrifugal force, will fall towards the vertical spindle, and the throttle valve, *t*, will be more fully opened, whereby a more ample supply of steam will be admitted to the cylinder, and the speed of the engine will be increased to the requisite extent.

97. *Q.* — The piston must be made to fit the cylinder accurately so as to prevent the passage of steam?

A.—The piston is accurately fitted to the cylinder, and made to move in it steam tight by a packing of hemp driven tightly into a groove or recess round the edge of the piston, and which is squeezed down by an iron ring held by screws. The piston divides the cylinder into two compartments, between which there is no communication by which steam or any other elastic fluid can pass. A casing *B B'*, set beside the cylinder contains the valves, by means of which the steam which impels the piston is admitted and withdrawn, as the piston commences its motion in each direction. The upper steam box *B* is divided into three compartments by two valves. Above the upper steam valve *v* is a compartment communicating with the steam pipe *s*. Below the lower valve *e* is another compartment communicating with a pipe called the eduction pipe, which leads downwards from

the cylinder to the condenser, in which vessel the steam is condensed by a jet of cold water. By the valve *v*, a communication may be opened or closed between the boiler and the top of the cylinder, so as to permit or prevent a supply of steam from the one to pass to the other. By the valve *ε* a communication may be open or closed between the top of the cylinder and the condenser, so that the steam in the top compartment of the cylinder may either be permitted to escape into the condenser, or may be confined to the cylinder. The continuation of the steam pipe *s'* leads to the lower steam box *B'*, which, like the upper, is divided into three compartments by two valves *v'* and *ε'*, and the action of the lower valves is in all respects the same as that of the upper.

98. *Q.* — Are all these valves connected together so that they act simultaneously ?

A. — The four valves *v ε, v' ε'* are connected by rods to a single handle *m*, which handle is moved alternately up and down by means of pins or tappets, placed on the rod which works the air pump. When the handle *m* is pressed down, the levers in connexion with it open the upper exhausting valve *ε* and the lower steam valve *v'*, and close the upper steam valve *v* and the lower exhausting valve *ε'*. On the other hand, when the handle *m* is pressed up it opens the upper steam valve *v* and the lower exhausting valve *ε'*, and at the same time closes the upper exhausting valve *ε* and the lower steam valve *v'*.

99. *Q.* — Where is the condenser situated ?

A. — The condenser *D* is immersed in a cistern of cold water. At its side there is a tube *I*, for the admission of water to condense the steam, and which is governed by a cock, by opening which to any required extent, a jet of cold water may be made to play in the condenser. From the bottom of the condenser a short pipe leads to the air pump *K'*, and in this pipe there is a flap valve *M*, called the foot valve, opening towards the air pump. The air pump is a pump set in the same cistern of cold water that holds the condenser, and it is fitted with a piston or bucket worked by the rod *R*, attached to the great beam, and fitted with a valve opening upwards in the manner of a common sucking pump. The upper part of the air pump communicates with a small cistern *K*, called the hot well, through a valve opening outwards and called the delivery valve. A pump *L*, called the hot water pump, lifts hot water out of the hot well to feed the boiler, and another pump *N* lifts cold water from a well or other source of supply, to maintain the supply of water to the cold water cistern, in which the condenser and air pump are placed.

100. *Q.*—Will you explain now the manner in which the engine acts?

A. — The piston being supposed to be at the top of the cylinder, the handle *m* will be raised by the lower pin or tappet on the air pump rod, and the valves *v* and *E'* will be opened, and at the same time the other pair of valves *v'* and *E* will be closed. Steam will therefore be admitted above the piston, and the steam or air which had previously filled the cylinder below the piston will be drawn off to the condenser. It

will there encounter the jet of cold water, which is kept constantly playing there by keeping the cock *x* sufficiently open. It will thus be immediately condensed or reduced to water, and the cylinder below the piston will have a vacuum in it. The steam therefore admitted from the steam pipe through the open valve *v* to the top of the cylinder, not being resisted by pressure below, will press the piston to the bottom of the cylinder. As it approaches that position, the handle *m* will be struck down by the upper pin or tappet on the air pump rod, and the valves *v* and *x'*, previously open, will be closed, while the valves *v'* and *x*, previously closed, will be opened. The steam which has just pressed down the piston, and which now fills the cylinder above the piston, will then flow off, through the open valve *x*, to the condenser, where it will be immediately condensed by the jet of cold water; and steam from the boiler, admitted through the open valve *v'*, will fill the cylinder below the piston, and press the piston upwards. When the piston has reached the top of the cylinder, the lower pin on the air pump rod will have struck the handle upwards, and will thereby have closed the valves *v'* and *x*, and opened the valves *v* and *x'*. The piston will then be in the same situation as in the commencement, and will again descend, and so will continue to be driven up and down by the steam.

101. Q.—But what becomes of the cold water which is let into the condenser to condense the steam?

A.—It is pumped out by the air pump in the shape of hot water, its temperature having been raised con-

siderably by the admixture of the steam with it. When the air pump piston ascends it leaves behind it a vacuum ; and the foot valve *m*, being relieved from all pressure, the weight of the water in the condenser forces it open, and the warm water flows from the condenser into the lower part of the air pump, from which its return to the condenser is prevented by the intervening valve. When the air pump piston descends, its pressure on the liquid under it will force open the valve in it, through which the hot water will ascend ; and when the bucket descends to the bottom of the pump barrel, the warm water which was below it will all have passed above it, and cannot return. When the bucket next ascends, the water above it, not being able to return through the bucket valve, will be forced into the hot well through the delivery valve *k*. The hot water pump *L* pumps a small quantity of this hot water into the boiler, to compensate for the abstraction of the water that has passed off in the form of steam. The residue of the hot water runs to waste.

102. *Q.*—By what expedient is the piston rod enabled to pass through the cylinder cover without leaking steam out of the cylinder or air into it ?

A.—The hole in the cylinder lid, through which the piston rod passes, is furnished with a recess called a stuffing box, into which a stuffing or packing of plaited hemp is forced, which, pressing on the one side against the interior of the stuffing box, and on the other side against the piston rod, which is smooth and polished, prevents any leakage in this situation. The packing of this stuffing box is forced down by a

ring of metal tightened by screws. This ring, which accurately fits the piston rod, has a projecting flange, through which bolts pass for tightening the ring down upon the packing; and a similar expedient is employed in nearly every case in which packing is employed.

103. Q.—In what way is the piston rod connected to the great beam?

A.—The piston rod is connected to the great beam by means of two links, one at each side of the beam, shown at *fg*. These links are usually made of the same length as the crank, and their purpose is to enable the end of the great beam to move in the arc of a circle while the piston rod maintains the vertical position. The point of junction, therefore, of the links and the piston rod is of the form of a knuckle or bend at some parts of the stroke.

104. Q.—But what compels the top of the piston rod to maintain the vertical position?

A.—Some engines have guide rods set on each side of the piston rod, and eyes on the top of the piston rod engage these guide rods, and maintain the piston rod in a vertical position in every part of the stroke. More commonly, however, the desired end is attained by means of a contrivance called the parallel motion.

105. Q.—What is the parallel motion?

A.—The parallel motion is an arrangement of jointed rods, so connected together that the divergence from the vertical line at any point in the arc described by the beam is corrected by an equal and opposite divergence due to the arc performed by the jointed rods during the stroke; and as these opposite deviations

mutually correct one another, the result is that the piston rod moves in a vertical direction.

106. Q.— Will you explain the action more in detail?

A.— The pin which passes through the end of the beam at f has a link $f g$ hung on each side of the beam, and a short cross bar, called a cross head, extends from the bottom of one of these links to the bottom of the other, which cross head is perforated with a hole in the middle for the reception of the piston rod. There are similar links $b d$ at the point of the main beam, where the air pump rod is attached. There are two rods $d g$ connecting the links $b d$ with the links $f g$, and these rods, as they always continue parallel to the main beam throughout the stroke, are called *parallel bars*. Attached to the ends of these two rods at d are two other rods $c d$, of which the ends at c are attached to stationary pins, while the ends at d follow the motion of the lower ends of the links $b d$. These rods are called the *radius bars*. Now it is obvious that the arc described by the point d , with c as a centre, is opposite to the arc described by the point g , with d as a centre. The rod $d g$ is, therefore, drawn back horizontally by the arc described at d to an extent equal to the versed sine of the arc described at g , or, in other words, the line described by the point g becomes a straight line instead of a curve.

107. Q.— Does the air pump rod move vertically as well as the piston rod?

A.— It does. The air pump rod is suspended from a cross head, passing from the centre of one of the

links $b d$ to the centre of the other link, on the opposite side of the beam. Now, as the distance from the central axis of the great beam to the point b is equal to the length of the rod $c d$, it will follow that the upper end of the link will follow one arc, and the lower end an equal and opposite arc. A point in the centre of the link, therefore, where these opposite motions meet, will follow no arc at all, but will move up and down vertically in a straight line.

108. Q.—The use of the crank is to obtain a circular motion from a reciprocating motion ?

A.—That is the object of it, and it accomplishes its object in a very perfect manner, as it gradually arrests the velocity of the piston towards the end of the stroke, and thus obviates what would otherwise be an injurious shock upon the machine. When the crank approaches the lowest part of its throw, and at the same time the piston is approaching the top of the cylinder, the motion of the crank becomes nearly horizontal, or, in other words, the piston is only advanced, through a very short distance, for any given distance measured on the circle described by the crank pin. Since, then, the velocity of rotation of the crank is nearly uniform, it will follow that the piston will move very slowly as it approaches the end of the stroke ; and the piston is brought to a state of rest by this gradually retarded motion, both at the top and the bottom of the stroke.

109. Q.—What causes the crank to revolve at a uniform velocity ?

A.—The momentum of the machinery moved by the piston, but more especially of the fly wheel, which

by its operation redresses the unequal pressures communicated by the crank, and compels the crank shaft to revolve at a nearly uniform velocity. Everyone knows that a heavy wheel if put into rapid rotation cannot be immediately stopped. At the beginning and end of the stroke when the crank is vertical, no force of torsion can be exerted on the crank shaft by the crank, but this force is at its maximum when the crank is horizontal. From the vertical point, where this force is nothing, to the horizontal point, where it is at its maximum, the force of torsion exerted on the crank shaft is constantly varying; and the fly wheel by its momentum redresses these irregularities, and carries the crank through that "dead point," as it is termed, where the piston cannot impart any rotative force.

110. Q.—Are the configuration and structure of the steam engine, as it left the hand of Watt, materially different from those of modern engines?

A.—There is not much difference. In modern rotative land engines, the valves for admitting the steam to the cylinder or condenser, instead of being clack or pot-lid valves moved by tappets on the air pump rod, are usually sluice or sliding valves, moved by an eccentric wheel on the crank shaft. Sometimes the beam is discarded altogether, and malleable iron is more largely used in the construction of engines instead of the cast iron, which formerly so largely prevailed. But upon the whole the steam engine of the present day is substantially the engine of Watt; and he who perfectly understands the operation of Watt's engine, will have no difficulty in understanding

the operation of any of the numerous varieties of engines since introduced.

THE MARINE ENGINE.

111. *Q.*—Will you describe the principal features of the kind of steam engine employed for the propulsion of vessels?

A.—Marine engines are of two kinds,—paddle engines and screw engines. In the one case the propelling instrument is paddle wheels kept in rotation at each side of the ship: in the other case, the propelling instrument is a screw, consisting of two or more twisted vanes, revolving beneath the water at the stern. Of each class of engines there are many distinct varieties.

112. *Q.*—What are the principal varieties of the paddle engine?

A.—There is the side lever engine, and the oscillating engine, besides numerous other forms of engine which are less known or employed, such as the trunk, double cylinder, annular, Gorgon, steeple, and many others. The side lever engine however, and the oscillating engine, are the only kinds of paddle engines which have been received with wide or general favour.

113. *Q.*—Will you explain the main distinctive features of the side lever engine?

A.—In all paddle vessels, whatever be their subordinate characteristics, a great shaft of wrought iron, turned round by the engine, has to be carried from side to side of the vessel, on which shaft are fixed the

paddle wheels. The paddle wheels may either be formed with fixed float boards for engaging the water, like the boards of a common undershot water wheel, or they may be formed with *feathering* float boards as they are termed, which is float boards movable on a centre, and so governed by appropriate mechanism that they enter and leave the water in a nearly vertical position. The fixed floats are attached by bolts to the arms of two or more rings of malleable iron which are fixed by appropriate centres on the paddle shaft, and the feathering floats swing on horizontal spindles. It is usual in steam vessels to employ two engines, the cranks of which are set at right angles with one another. When the paddle wheels are turned by the engines, the float boards engaging the water cause a forward thrust to be imparted to the shaft, which propels forward the vessel on the same principle that a boat is propelled by the action of oars.

114. Q.—These remarks apply to all paddle vessels?

A.—They do. With respect to the side lever engine, it may be described to be such a modification of the land beam engine, already described, as will enable it to be got below the deck of a vessel. With this view, instead of a single beam being placed overhead, two beams are used, one of which is set on each side of the engine as low down as possible. The cross head which engages the piston rod is made somewhat longer than the diameter of the cylinder, and two great links or rods proceed one from each end of the cross head to one end of the side levers or

beams. A similar cross bar at the other end of the beams serves to connect them together and to the connecting rod, which, proceeding from thence upwards, engages the crank, and thereby turns round the paddle wheels.

115. Q.—Will you further illustrate this general description by an example?

A.—I will take as an example the engines constructed by Messrs. Boulton and Watt for the steamers Red Rover and City of Canterbury, and which were in successful and constant use for a great number of years. *Fig. 13.* is a longitudinal section of both engine and boiler; *xx* represent the beams or keelsons to which the engines are attached, and on which the boilers rest. The engines are tied down by strong bolts passing through the bottom of the vessel, but the boiler keeps its position by its weight alone; *s* is the steam pipe leading from the steam chest of the boiler to the slide or sluice valve *c*, by which the steam is admitted alternately to the top and bottom of the cylinder. *B* is the condenser and *E* the air pump, which is worked off the side levers by means of side rods and a cross head. A strong gudgeon, called the *main centre*, passes through the condenser at *K*, the projecting ends of which serve to support the side levers or beams. *F* is the hot well, out of which the feed pump draws water to replenish the boiler, which is forced through the pipe *IL*. *L* is the piston rod which, by means of the cross head and side rods, is connected to the side levers or beams, one of which is shown in dotted lines at *HH*, as being at the back of the engine, the other being supposed to be removed

Fig. 13

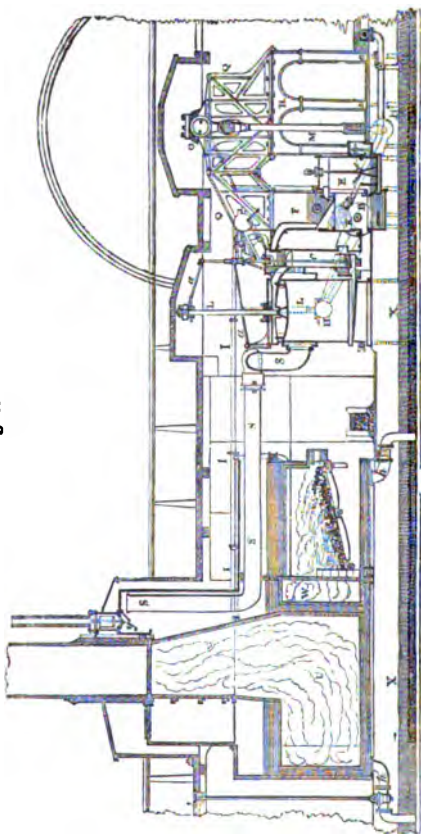

SIDE LEVER MARINE ENGINES AND FLOUR BOILERS. By Messrs. Boulton and Watt.
 Longitudinal Section through Vessel.

to enable the engine to be shown in section. **x** is the connecting rod, to which motion is imparted by the

beams, through the medium of the cross tail extending between the beams, and which by means of the crank turns the paddle shaft *o*. The framing upon which the paddle shaft rests is denoted by *q r*, and the rods of the parallel motion by *a a*. The eccentric which works the slide valve is placed upon the paddle shaft. It consists of a disc of metal encircled by a hoop, to which a rod is attached, and the disc is perforated with a hole for the shaft, not in the centre, but near one edge. When, therefore, the shaft revolves, carrying the eccentric with it, the rod attached to the encircling hoop receives a reciprocating motion, just as it would do if attached to a crank in the shaft. The section of the boiler flues is represented by *w u*, the safety valve by *y*; and *h h* are cocks, by which the water in the boiler is blown out into the sea by the pressure of the steam, when the boilers require to be emptied, and also through which a portion of the water in the boiler is blown out from time to time, while the engine is at work, in order to prevent the sea water from reaching an injurious amount of concentration?

116. Q. — Will you describe the mode of starting the engine?

A. — I may first mention that when the engine is at rest, the connection between the eccentric and the slide valve is broken, by lifting the end of the eccentric rod out of a notch, which engages a pin on the valve shaft; and the valve is at such times free to be moved by hand by a bar of iron, applied to a proper part of the valve gear for that purpose. This being

so, the engineer, when he wishes to start the engine, first opens a small valve called the *blow through valve*, which permits steam from the boiler to enter the engine both above and below the piston, and also to fill the condenser and air pump. This steam expels the air from the interior of the engine, and also any water which may have accumulated there; and when this has been done, the blow through valve is shut, and a vacuum very soon forms within the engine, by the condensation of the steam. If now the slide valve be moved by hand, the steam from the boiler will be admitted on one side of the piston, while there is a vacuum on the other side, and the piston will, therefore, be moved in the desired direction. When the piston reaches the end of the stroke, the valve has to be moved in the reverse direction, when the piston will return, and after being moved thus by hand, once or twice, the connection of the valve with the eccentric is to be restored by allowing the notch on the end of the eccentric rod to engage the pin on the valve lever, when the valve will be thereafter moved by the engine in the proper manner. It will, of course, be necessary, when the engine begins to move, to open the injection cock a little, to enable water to enter for the condensation of the steam. In the most recent marine engines, a somewhat different mechanism from this is used for giving motion to the valves, but that mechanism will be afterwards described.

117. Q.—Are all marine engines condensing engines?

A.—Nearly all of them are so; but special vessels have at times been constructed with high

pressure engines. In general, however, marine engines are low pressure or condensing engines.

118. Q.—Will you now describe the chief features of the oscillating paddle marine engine?

A. — In the oscillating paddle marine engine, the arrangement of the paddle shaft and paddle wheels is the same as in the case already described, but the whole of the side levers, side rods, cross head, cross tail, and connecting rod are discarded. The cylinder is set immediately under the crank: the top of the piston rod is connected immediately to the crank pin; and, to enable the piston rod to accommodate itself to the movement of the crank, the cylinder is so constructed as to be susceptible of vibrating or oscillating upon two external axes or trunnions. These trunnions are generally placed about half-way up on the sides of the cylinder; and through one of them steam is received from the boiler, while through the other the steam escapes to the condenser. The air pump is usually worked by means of a crank in the shaft, which crank moves the air pump bucket up and down as the shaft revolves.

119. Q.—Will you give an example of a paddle oscillating engine?

A.—I will take as an example the oscillating engines constructed by Messrs. Rennie for the steamer Peterhoff; and this vessel was also fitted with feathering wheels. *Fig. 14.* is a transverse section of this vessel, showing the engines and wheels; and *fig. 15.* is a side view of the engines, showing also one of the wheels. There are two cylinders in this vessel, and one air pump, which lies in an inclined

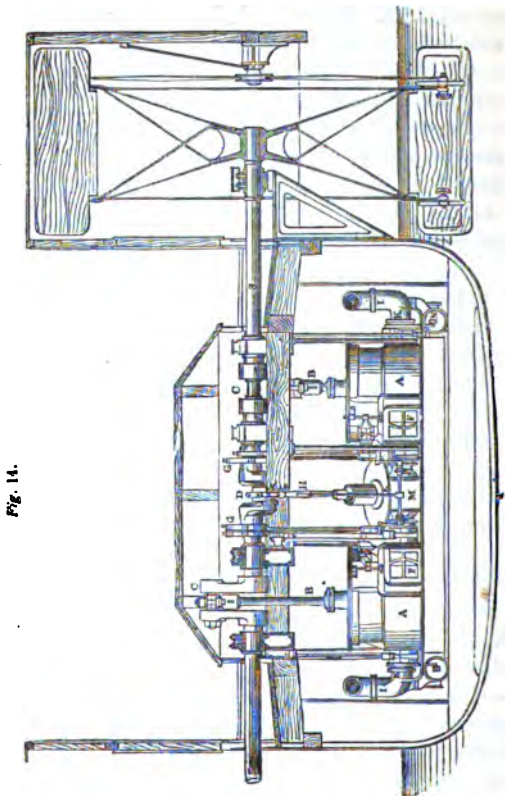

Fig. 14.

OSCILLATING MARINE ENGINES. By Messrs. Rennie.
Transverse Section through Vessel.

position, and is worked by a crank in the shaft which stretches between the cylinders, and which is called the *intermediate shaft*. A A, fig. 14., are the two

cylinders, B B the two piston rods, and C C the two cranks. D is the crank in the intermediate shaft, which works the air pump E; F F are the slide valves, by which the admission of the steam to the cylinders is regulated. G G are double eccentrics fixed on the shaft, whereby the movement of the slide valves is regulated. The purpose of the double eccentrics is to enable a particular arrangement of valve gear to be employed which is denominated the *link motion*, and which will be described hereafter. H is a handle whereby the engine may be instantly stopped, started, or reversed, without the necessity of detaching the eccentric rod from the valve motion, as is necessary where the link motion is not employed. I I are the steam pipes leading to the steam trunnions K K, on which, and on the eduction trunnions connected with the pipe M, the cylinders oscillate. In *fig. 15*. N N are pumps, the pistons of which are attached to the trunnions, and are worked by the oscillation of the cylinders; O, in the same figure, is the waste water pipe, through which is discharged overboard the whole of the water lifted out of the condenser by the air pump, except that small portion employed for feeding the boiler.

120. Q.—By what species of mechanism are the positions of the paddle floats of this vessel governed?

A.—The floats are supported by spurs projecting from the rim of the wheel, and they are moved upon the points of the spurs, to which they are attached by pins, by means of short levers proceeding from the backs of the floats, and connected to rods which proceed towards the centre of the wheel. The

Fig. 15.

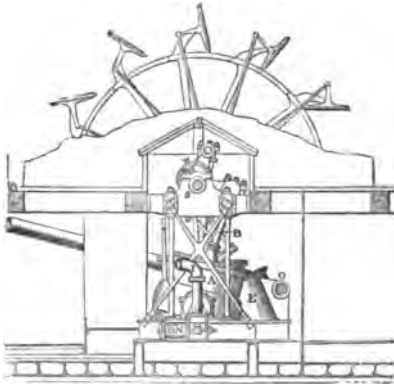

OSCILLATING MARINE ENGINES. By Messrs. Rennie.
Longitudinal Section through Vessel.

centre, however, to which these rods proceed is not concentric with the wheel, and the rods, therefore, are moved in and out as the wheel revolves, and impart a corresponding motion to the floats. In some feathering wheels the proper motion is given to the rods by means of an eccentric on the ship's side. The action of paddle wheels, whether radial or feathering, will be more fully described in the chapter on Steam Navigation.

SCREW ENGINES.

121. Q.—What are the principal varieties of screw engines?

A.—The engines employed for the propulsion of

screw vessels are divided into two great classes,—geared engines and direct acting engines ; and each of these classes again has many varieties. In screw vessels, the shaft on which the screw is set requires to revolve at a much greater velocity than is required in the case of the paddle shaft of a paddle vessel ; and in geared engines this necessary velocity of rotation is obtained by the intervention of toothed wheels,—the engines themselves moving with the usual velocity of paddle engines ; whereas in direct acting engines the required velocity of rotation is obtained by accelerating the speed of the engines, and which are connected immediately to the screw shaft.

122. Q. — Will you describe some of the principal varieties of geared engines ?

A. — A good many of the geared engines for screw vessels are made in the same manner as land engines, with a beam overhead, which by means of a connecting rod extending downwards, gives motion to the crank shaft, on which is set the cog wheels which give motion to pinions on the screw shaft,—the teeth of the wheels being generally of wood and the teeth of the pinions of iron. There are usually several wheels on the crank shaft and several pinions on the screw shaft ; but the teeth of each do not run in the same line, but are set a little in advance of one another, so as to divide the thickness of the tooth into as many parts as there are independent wheels or pinions. By this arrangement the wheels work more smoothly than they would otherwise do.

123. Q. — What other forms are there of geared screw engines ?

Fig. 10.

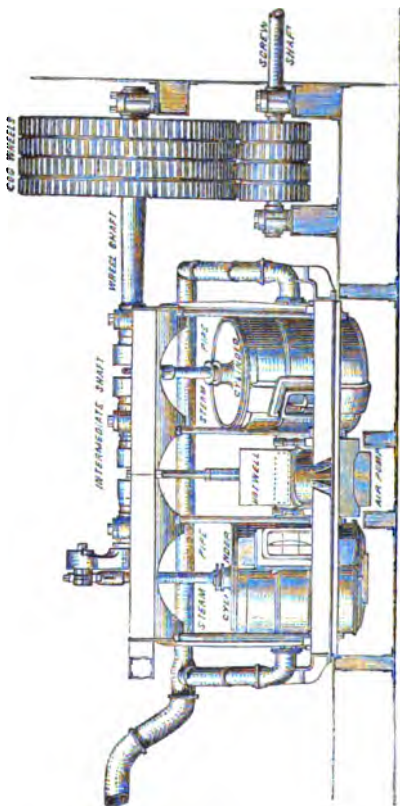

GEARED MARINE SCREW ENGINES OF THE GREAT BRITAIN STRAITS.

By Messrs. John Penn and Son.

A. — In some cases the cylinders lie on their sides in the manner of the cylinders of a locomotive engine.

In other cases vertical trunk engines are employed; and in other cases vertical oscillating engines.

124. Q. — Will you give an example of a geared vertical oscillating engine?

A. — I will give as an example of this species of engine, the geared oscillating engines of the steamship Great Britain, constructed by Messrs. John Penn and Son, and which are represented in *fig.* 16. These engines in all their main features, except in the use of gearing, are identical in construction with the oscillating paddle engines of the same makers. The names of the principal parts of the engine being written upon them, any detailed description of the engine is not required. The engines of the Great Britain are made off the same patterns as the paddle engines constructed by Messrs. John Penn and Son for H.M.S. Sphinx. The diameter of each cylinder is $82\frac{1}{2}$ inches, the length of travel or stroke of the piston is 6 feet, and the nominal power is 500 horses. The Great Britain is of 3500 tons burden, and her displacement at 16 feet draught of water is 2970 tons. The diameter of the screw is $15\frac{1}{2}$ feet, length of screw in the line of the shaft 3 feet 2 inches, and the pitch of the screw 19 feet.

125. Q. — What do you mean by the pitch of the screw?

A. — A screw propeller may be supposed to be a short piece cut off a screw of large diameter like a spiral stair, and the pitch of a spiral stair is the vertical height from any given step to the step immediately overhead.

126. Q. — What is the usual number of arms?

A. — Generally a screw has two arms, but sometimes it has three or more. The Great Britain had three arms or twisted blades resembling the vanes of a windmill. The multiple of the gearing in the Great Britain is 3 to 1, and there are $17\frac{1}{2}$ square feet of heating surface in the boiler for each nominal horse power. The crank shaft being put into motion by the engine, carries round with it the great cog wheel, or aggregation of cog wheels, affixed to its extremity; and these wheels acting on suitable pinions on the screw shaft, cause the screw to make three revolutions for every revolution made by the engine.

127. *Q.* — What are the principal varieties of direct acting screw engines?

A. — In some cases four engines have been employed instead of two, and the cylinders have been laid on their sides on each side of the screw shaft. This multiplication of engines however introduces needless complication, and is now but little used. In other cases two inverted cylinders are set above the screw shaft on appropriate framing; and connecting rods attached to the ends of the piston rods turn round cranks in the screw shaft.

128. *Q.* — What is the kind of direct acting screw engine employed by Messrs. Penn.

A. — It is a horizontal trunk engine, and is represented in section in *fig.* 17. In this engine a round pipe called a trunk penetrates the piston, to which it is fixed, being in fact cast in one piece with it; and the trunk also penetrates the top and bottom of the cylinder, through which it moves, and is made tight therein by means of stuffing boxes. The connecting

rod is attached at one end to a pin fixed in the middle of the trunk, while the other end engages the crank

Fig. 17.

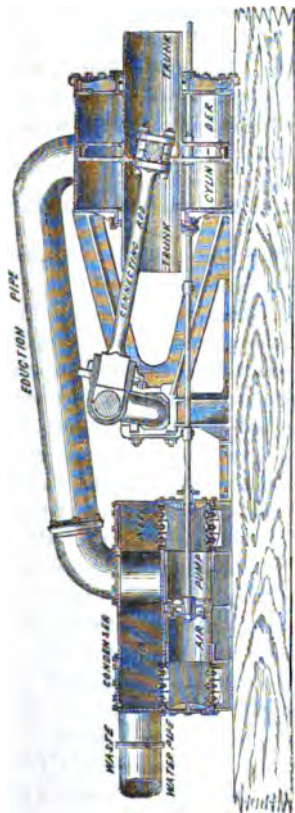

DIRECT ACTING MARINE SCREW ENGINES. By Messrs. John Penn and Son.
Longitudinal Section.

in the usual manner. The air pump is set within the condenser, and is wrought by a rod which is fixed to

the piston and derives its motion therefrom. The air pump is of that species which is called double-acting. The piston or bucket is formed without valves in it, but an inlet and outlet valve is fixed to each end of the pump, through the one of which the water is drawn into the pump barrel, and through the other of which it is expelled into the hot well.

THE LOCOMOTIVE ENGINE.

129. Q. — Will you describe the more important features of the locomotive engine?

A. — The locomotive employed to draw carriages upon railways, consists of a cylindrical boiler filled with brass tubes, through which the hot air passes on its progress from the furnace to the chimney; and attached to the boiler are two horizontal cylinders fitted with pistons, valves, connecting rods, and other necessary apparatus to enable the power exerted by the pistons to turn round the cranked axle to which the driving wheels are attached. There are, therefore, two independent engines entering into the composition of a locomotive, the cranks of which are set at right angles with one another, so that when one crank is at its dead point, the other crank is in a position to act with its maximum efficacy. The driving wheels which are fixed on the crank shaft and turn round with it, propel the locomotive forward on the rails by the mere adhesion of friction, and this is found sufficient not merely to move the locomotive, but to draw a long train of carriages behind it.

130. Q.—Are locomotive engines condensing or high pressure engines.

A.—They are invariably high pressure engines, as it would be impossible, or at least highly inconvenient, to carry the water necessary for the purpose of condensation. The steam, therefore, after it has urged the piston to the end of the stroke, escapes into the atmosphere. In locomotive engines the waste steam is always discharged into the chimney through a vertical pipe, and by its rapid passage it greatly increases the intensity of the draught in the chimney, whereby a smaller fire grate suffices for the combustion of the fuel, and the evaporative power of the boiler is much increased.

131. Q.—Can you give an example of a locomotive engine of the usual form.

A.—To do this I will take the example of one of Stephenson's locomotive engines with six wheels represented in *fig. 18.*;—not one of the most modern construction now in use, nor yet one of the most antiquated. *a* is the cylinder, *b* the connecting rod, *c* the crank, *d* the eccentric by which the slide valve is moved; *eee* is the steam pipe by which the steam is conducted from the steam dome of the boiler to the cylinder. Near the furnace end of this pipe is a valve or regulator moved by a handle at the front of the boiler, and of which the purpose is to regulate the admission of the steam to the cylinder; *ff* are safety valves kept closed by springs; *g* is the education pipe, or, as it is commonly termed in locomotives, the *blast pipe*, by which the steam, escaping from the cylinder after the stroke has been performed, is pro-

STEPHENSON'S LOCOMOTIVE ENGINE.

Fig. 18.

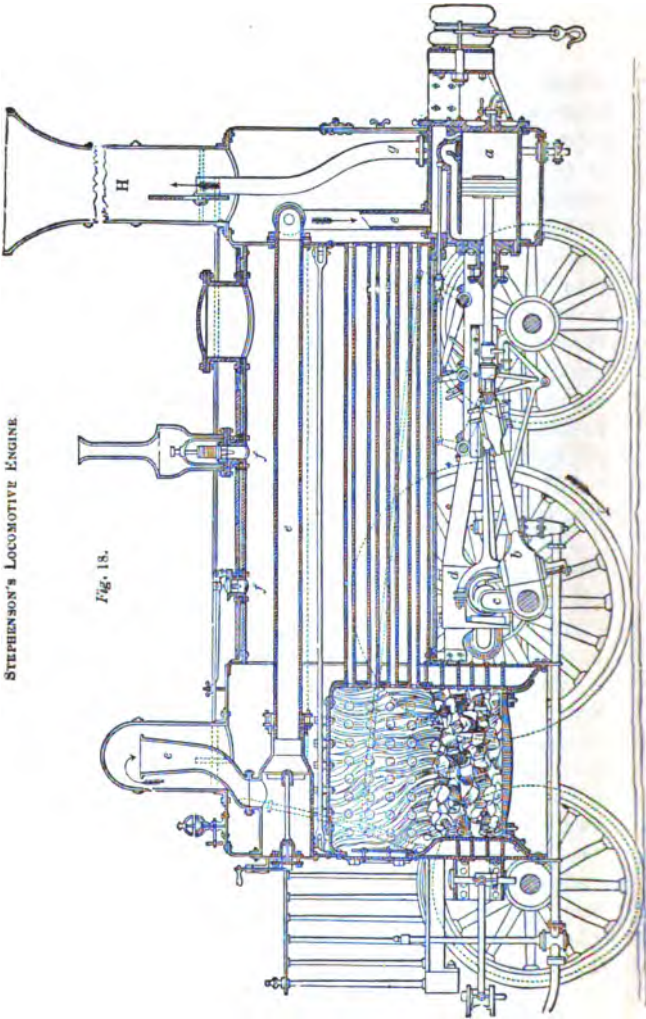

jected up the chimney H. The water in the boiler of course covers the tubes, and also the top of the furnace or fire box. The position of the water surface is shown by a dotted line. It will be understood that there are two engines in each locomotive, though, from the figure being given in section, only one engine can be shown. The cylinders of this engine are each 12 inches diameter; the length of the stroke of the piston is 18 inches, and the diameter of the driving wheel is 5 feet.

132. Q.—What is the tender of a locomotive?

A.—It is a carriage attached to the locomotive, of which the purpose is to contain coke for feeding the furnace, and water for replenishing the boiler.

133. Q.—Can you give examples of modern locomotives?

A.—The most recent locomotives resemble in their material features the locomotive represented in *fig. 18*. I can, however, give examples of some of the most powerful engines of common construction. *Fig. 19*.

Fig. 19.

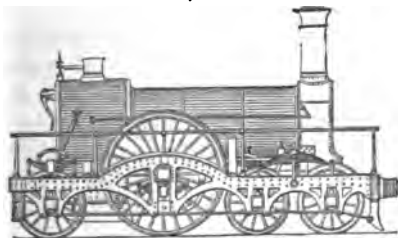

GOUGH'S LOCOMOTIVE ENGINE; for the Wide Gauge.

represents Gooch's express engine adapted for the wide gauge of the Great Western Railway; and *fig.* 20. represents Crampton's express engine adapted

Fig. 20.

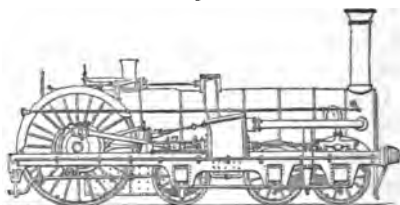

CRAMPTON'S LOCOMOTIVE ENGINE; for the Narrow Gauge.

for the ordinary or narrow gauge railways. The cylinders of Gooch's engine are each 18 inches diameter, and 24 inches stroke; the driving wheels are 8 feet in diameter; the fire grate contains 21 square feet of area; and the heating surface of the fire box is 153 square feet. There are in all 305 tubes in the boiler, each of 2 inches diameter, giving a heating surface in the tubes of 1799 square feet. The total heating surface, therefore, is 1952 square feet. Mr. Gooch states that an engine of this class will evaporate from 300 to 360 cubic feet of water in the hour, and will convey a load of 236 tons at a speed of 40 miles an hour, or a load of 181 tons at a speed of 60 miles an hour. The weight of this engine empty is 31 tons; of the tender $8\frac{1}{2}$ tons; and the total weight of the engine when loaded is 50 tons. In Crampton's locomotive, the Liverpool, the cylinders are of 24 inches diameter and 18 inches stroke; the driving wheels are 8 feet in diameter; the fire grate

contains $21\frac{1}{2}$ square feet of area; and the heating surface of the fire box is 154 square feet. There are in all 300 tubes in the boiler of $2\frac{3}{8}$ inches external diameter, giving a surface in the tubes of 2136 square feet, and a total heating surface of 2290 square feet. The weight of this engine is stated to be 35 tons when ready to proceed on a journey. Both engines were displayed at the Great Exhibition in 1851, as examples of the most powerful locomotive engines then made. The weight of such engines is very injurious to the railway; bending, crushing, and disturbing the rails, and trying very severely the whole of the railway works. No doubt the weight might be distributed upon a greater number of wheels, but if the weight resting on the driving wheels be much reduced, they will not have sufficient bite upon the rails to propel the train without slipping. This, however, is only one of the evils which the demand for high rates of speed has produced. The width of the railway or, as it is termed, the *gauge* of the rails, being in most of the railways in this kingdom limited to 4 feet $8\frac{1}{2}$ inches, a corresponding limitation is imposed on the diameter of the boiler; which in its turn restricts the number of the tubes which can be employed. As, however, the attainment of a high rate of speed requires much power, and consequently much heating surface in the boiler, and as the number of tubes cannot be increased without reducing their diameter, it has become necessary, in the case of powerful engines, to employ tubes of a small diameter, and of a great length, to obtain the necessary quantity of heating surface; and such tubes require a very

strong draught in the chimney to make them effective. With a draught of the usual intensity the whole of the heat will be absorbed in the portion of the tube nearest the fire box,—leaving that portion nearest the smoke box nothing to do but to transmit the smoke ; and with long tubes of small diameter, therefore, a very strong draught is indispensable. To obtain such a draught in locomotives, it is necessary to contract the mouth of the blast pipe, whereby the waste steam will be projected into the chimney with greater force ; but this contraction involves an increase of the pressure on the eduction side of the piston, and consequently causes a diminution in the power of the engine. Locomotives with small and long tubes, therefore, will require more coke to do the same work than locomotives in which larger and shorter tubes may be employed

CHAP. II.

HEAT, COMBUSTION, AND STEAM.

HEAT.

134. Q.—What is meant by latent heat?

A.—By latent heat is meant the heat existing in bodies which is not discoverable by the touch or by the thermometer, but which manifests its existence by producing a change of state. Heat is absorbed in the liquefaction of ice, and in the vaporisation of water, yet the temperature does not rise during either process, and the heat absorbed is therefore said to become latent. The term is somewhat objectionable, as the effect proper to the absorption of heat has in each case been made visible; and it would be as reasonable to call hot water latent steam. Latent heat, in the present acceptation of the term, means sensible liquefaction or vaporisation; but to produce these changes heat is as necessary as to produce the expansion of mercury in a thermometer tube, which is taken as the measure of temperature; and it is hard to see on what ground heat can be said to be latent when its presence is made manifest by changes which only heat can effect. It is the *temperature* only that is latent, and latent temperature means sensible vaporisation or liquefaction.

135. Q.—But when you talk of the latent heat of steam, what do you mean to express?

A.—I mean to express the heat consumed in accomplishing the vaporisation compared with that necessary for producing the temperature. The latent heat of steam is usually reckoned at about 1000 degrees, by which it is meant that there is as much heat in any given weight of steam as would raise its constituent water 1000 degrees if the expansion of the water could be prevented, or as would raise 1000 times that quantity of water one degree. The boiling point of water being 212 degrees, is 180 degrees above the freezing point of water—the freezing point being 32 degrees; so that it requires 1180 times as much heat to raise 1 lb. of water into steam, as to raise 1 lb. of water one degree; or it requires about as much heat to raise a pound of boiling water into steam as would raise $5\frac{1}{2}$ lbs. of water from the freezing to the boiling point; $5\frac{1}{2}$ multiplied by 180 being 990, or 1000 nearly.

136. Q.—When it is stated that the latent heat of steam is 1000 degrees, it is only meant that this is a rough approximation to the truth?

A.—Precisely so. The latent heat, in point of fact, is not uniform at all temperatures, neither is the total amount of heat the same at all temperatures. M. Regnault has shown, by a very elaborate series of experiments on steam, which he has lately concluded, that the total heat in steam increases somewhat with the pressure, and that the latent heat diminishes somewhat with the pressure. This will be made obvious by the following numbers:—

EXPLANATION OF THE NATURE OF SPECIFIC HEAT. 89

Pressure.	Temperature.	Total Heat.	Latent Heat.
15 lbs.	213·1°	1178·9°	965·8°
50	281·0	1199·6	918·6
100	327·8	1213·9	886·1

If, then, steam of 100 lbs. be expanded down to steam of 15 lbs., it will have 35 degrees of heat over that which is required for the maintenance of the vaporous state, or, in other words, it will be surcharged with heat.

137. Q.—What do you understand by specific heat?

A.—By specific heat, I understand the relative quantities of heat in bodies at the same temperature, just as by specific gravity I understand the relative quantities of matter in bodies of the same bulk. Equal weights of quicksilver and water at the same temperature do not contain the same quantities of heat, any more than equal bulks of those liquids contain the same quantity of matter. The absolute quantity of heat in any body is not known; but the relative heat of bodies at the same temperature, or in other words their specific heats, have been ascertained and arranged in tables, — the specific heat of water being taken as unity.

138. Q.—In what way does the specific heat of a body enable the quantity of heat in it to be determined?

A.—If any body has only half the specific heat of water, then a pound of that body will, at any given temperature, have only half the heat in it that is in a pound of water at the same temperature. The specific heat of air is ·2377, that of water being 1; or it is 4·207 times less than that of water. An amount of

heat, therefore, which would raise a pound of water 1 degree would raise a pound of air 4·207 degrees.

COMBUSTION.

139. *Q.*—What is the nature of combustion?

A.—Combustion is nothing more than an energetic chemical combination, or, in other words, it is the mutual neutralisation of opposing electricities. When coal is brought to a high temperature it acquires a strong affinity for oxygen, and combination with oxygen will produce more than sufficient heat to maintain the original temperature; so that part of the heat is rendered applicable to other purposes.

140. *Q.*—Does air consist of oxygen?

A.—Air consists of oxygen and nitrogen mixed together in the proportion of 3·29 lbs. of nitrogen to 1 lb. of oxygen. Every pound of coal requires about 2·66 lbs. of oxygen for its saturation, and therefore for every pound of coal burned 8·75 pounds of nitrogen must pass through the fire, supposing all the oxygen to enter into combination. In practice, however, this perfection of combination does not exist: from one-third to one-half of the oxygen will pass through the fire without entering into combination at all; so that from 16 to 18 lbs. of air are required for every pound of coal burned. 18 lbs. of air are about 240 cubic feet, which may be taken as the quantity of air required for the combustion of a pound of coal in practice.

141. *Q.*—What are the constituents of coal?

A.—The chief constituent of coal is carbon or pure charcoal, which is associated in various proportions

with volatile and earthy matters. English coal contains 80 to 90 per cent. of carbon, and from 8 to 18 per cent. of volatile and earthy matters, but sometimes more than this. The volatile matters are hydrogen, nitrogen, oxygen, and sulphur.

142. Q.—What is the difference between anthracite and bituminous coal?

A.—Anthracite consists almost entirely of carbon, having 91 per cent. of carbon, with about 7 per cent. of volatile matter and 2 per cent. of ashes. Newcastle coal contains about 83 per cent. of carbon, 14 per cent. of volatile matter, and 3 per cent. of ashes.

143. Q.—Will you recapitulate the steps by which you determine the quantity of air required for the combustion of coal?

A.—Looking to the quantity of oxygen required to unite chemically with the various constituents of the coal, we find for example that in 100 lbs. of anthracite coal, consisting of 91.44 lbs. of carbon, and 3.46 lbs. of hydrogen, we shall for the 91.44 lbs. of carbon require 243.84 lbs. of oxygen—since to saturate a pound of carbon by the formation of carbonic acid, requires $2\frac{2}{3}$ lbs. of oxygen. To saturate a pound of hydrogen in the formation of water, requires 8 lbs. of oxygen; hence 3.46 lbs. of hydrogen will take 27.68 lbs. of oxygen for its saturation. If then we add 243.84 lbs. to 27.68 lbs. we have 271.52 lbs. of oxygen required for the combustion of 100 lbs. of coal. A given weight of air contains nearly 23.32 per cent. of oxygen; hence to obtain 271.52 lbs. of oxygen, we must have about four times that quantity of atmospheric air, or more accurately, 1164 lbs. of air for the combustion of 100 lbs.

of coal. A cubic foot of air at ordinary temperatures weighs about .075 lbs; so that 100 lbs. of coal require 15,524 cubic feet of air, or 1 lb. of coal requires about 155 cubic feet of air, supposing every atom of the oxygen to enter into combination. If then, from one-third to one-half of the air passes unconsumed through the fire, an allowance of 240 cubic feet of air for each pound of coal will be a small enough allowance to answer the requirements of practice, and in some cases as much as 320 cubic feet will be required,—the difference depending mainly on the peculiar configuration of the furnace.

144. Q.—Can you state the evaporative efficacy of a pound of coal?

A.—The evaporative efficacy of a pound of carbon has been found experimentally to be equivalent to that necessary to raise 14,000 lbs. of water through 1 degree, or 14 lbs. of water through 1000 degrees, supposing the whole heat generated to be absorbed by the water. Now, if the water be raised into steam from a temperature of 60°, then 1118.9° of heat will have to be imparted to it to convert it into steam of 15 lbs. pressure per square inch. $14,000 \div 1118.9 = 12.512$ lbs. will be the number of pounds of water, therefore, which a pound of carbon can raise into steam of 15 lbs. pressure from a temperature of 60°. This, however, is a considerably larger result than can be expected in practice.

145. Q.—Then what is the result that may be expected in practice?

A.—The evaporative powers of different coals appear to be nearly proportional to the quantity of

carbon in them ; and bituminous coal is, therefore, less efficacious than coal consisting chiefly of pure carbon. A pound of the best Welsh or anthracite coal is capable of raising from $9\frac{1}{2}$ to 10 lbs. of water from 212° into steam, whereas a pound of the best Newcastle is not capable of raising more than about $8\frac{1}{2}$ lbs. of water from 212° into steam ; and inferior coals will not raise more than $6\frac{1}{2}$ lbs. of water into steam. In America it has been found that 1 lb. of the best coal is equal to $2\frac{1}{2}$ lbs. of pine wood, or, in some cases, to 3 lbs. ; and a pound of pine wood will not usually evaporate more than about $2\frac{1}{2}$ lbs. of water, though, by careful management, it may be made to evaporate $4\frac{1}{2}$ lbs. Turf will generate rather more steam than wood. Coke is equal or somewhat superior to the best coal in evaporative effect.

146. Q.—How much water will a pound of coal raise into steam in ordinary boilers ?

A.—From 6 to 8 lbs. of water in the generality of land boilers of medium quality, the difference depending on the kind of boiler, the kind of coal, and other circumstances. Mr. Watt reckoned his boilers as capable of evaporating 10·08 cubic feet of water with a bushel, or 84 lbs. of Newcastle coal, which is equivalent to $7\frac{1}{2}$ lbs. of water evaporated by 1 lb. of coal, and this may be taken as the performance of common land boilers at the present time. In some of the Cornish boilers, however, a pound of coal raises 11·8 lbs. of boiling water into steam, or a cwt. of coal evaporates about 21 cubic feet of water from 212° .

147. Q.—What method of firing ordinary furnaces is the best ?

A.—The coals should be broken up into small pieces, and sprinkled thinly and evenly over the fire a little at a time. The thickness of the stratum of coal upon the grate should depend upon the intensity of the draught: in ordinary land or marine boilers it should be thin, whereas in locomotive boilers it requires to be much thicker. If the stratum of coal be thick while the draught is sluggish, the carbonic acid resulting from combustion combines with an additional atom of carbon in passing through the fire, and is converted into carbonic oxide, which may be defined to be invisible smoke as it carries off a portion of the fuel: if, on the contrary the stratum of coal be thin while the draught is very rapid, an injurious refrigeration is occasioned by the excess of air passing through the furnace. The fire should always be spread of uniform thickness over the bars of the grate, and should be without any holes or uncovered places, which greatly diminish the effect of the fuel by the refrigeratory action of the stream of cold air which enters thereby. A wood fire requires to be about 6 inches thicker than a coal one, and a turf fire requires to be 3 or 4 inches thicker than a wood one, so that the furnace bars must be placed lower where wood or turf is burned, to enable the surface of the fire to be at the same distance from the bottom of the boiler.

148. *Q.*—Is a slow or a rapid combustion the most beneficial?

A.—A slow combustion is found by experiment to give the best results as regards economy of fuel, and theory tells us that the largest advantage will necessarily be obtained where adequate time has been afforded for a complete combination of the constituent

atoms of the combustible, and the supporter of combustion. In many of the cases, however, which occur in practice, a slow combustion is not attainable; but the tendencies of slow combustion are both to save the fuel, and to burn the smoke.

149. *Q.*—Is not the combustion in the furnaces of the Cornish boilers very slow?

A.—Yes, very slow; and there is in consequence very little smoke evolved. The coal used in Cornwall is Welsh coal, which evolves but little smoke, and is therefore more favourable for the success of a smokeless furnace; but in the manufacturing districts, where the coal is more bituminous, it is found that smoke may be almost wholly prevented by careful firing and by the use of a large capacity of furnace.

150. *Q.*—Do you consider slow combustion to be an advisable thing to practise in steam vessels?

A.—No, I do not. When the combustion is slow, the heat in the furnaces and flues is less intense, and a larger amount of heating surface consequently becomes necessary to absorb the heat. In locomotives where the heat of the furnace is very intense, there will be the same economy of fuel with an allowance of 5 or 6 square feet of surface to evaporate a cubic foot of water as in common marine boilers with 10 or 12.

151. *Q.*—What is the method of consuming smoke pursued in the manufacturing districts?

A.—In Manchester, where some stringent regulations for the prevention of smoke have for some time been in force, it is found that the readiest way of burning the smoke is to have a very large proportion of furnace room, whereby slow combustion may be

carried on. In some cases, too, a favourable result is arrived at by raising a ridge of coal across the furnace lying against the bridge, and of the same height: this ridge speedily becomes a mass of incandescent coke, which promotes the combustion of the smoke passing over it.

152. Q.—Is the method of admitting a stream of air into the flues to burn the smoke regarded favourably?

A.—No; it is found to be productive of injury to the boiler by the violent alternations of temperature it occasions, as at some times cold air impinges on the iron of the boiler, and at other times flame,—just as there happens to be smoke or no smoke emitted by the furnace. Boilers, therefore, operating upon this principle, speedily become leaky, and are much worn by oxidation, so that, if the pressure is considerable, they are liable to explode. It is very difficult to apportion the quantity of air admitted, to the varying wants of the fire; and as air may at some times be rushing in when there is no smoke to consume, a loss of heat, and an increased consumption of fuel may be the result of the arrangement; and, indeed, such is the result in practice, though a carefully performed experiment usually demonstrates a saving in fuel of 10 or 12 per cent.

153. Q.—What other plans have been contrived for obviating the nuisance of smoke?

A.—They are too various for enumeration, but most of them either operate upon the principle of admitting air into the flues to accomplish the combustion of the unflammable parts of the smoke, or seek to attain the same object by passing the smoke over or

through the fire or other incandescent material. Some of the plans, indeed, profess to burn the inflammable gases as they are evolved from the coal, without permitting the admixture of any of the unflammable products of combustion which enter into the composition of smoke; but this object has been very imperfectly fulfilled in any of the contrivances yet brought under the notice of the public, and in some cases these contrivances have been found to create weightier evils than they professed to relieve.

154. Q.—You refer, I suppose, to Mr. Charles Wye Williams' Argand furnace?

A.—I chiefly refer to it, though I also comprehend all other schemes in which there is a continuous admission of air into the flues, with an intermittent generation of smoke.

155. Q.—This is not so in Prideaux's furnace?

A.—No; in that furnace the air is admitted only during a certain interval, or for so long, in fact, as there is smoke to be consumed.

156. Q.—Will you explain the chief peculiarities of that furnace?

A.—The whole peculiarity is in the furnace door, which is represented shut in *fig. 21.* and open in *fig. 22.* The front of the door consists of metal venetians, which are opened when the top lever is lifted up, and shut when that lever descends to its lowest position. When the furnace door is opened to replenish the fire with coals, the top lever is raised up, and with it the piston of the small cylinder attached to the side of the furnace. The venetians are thereby opened, and a stream of air enters the furnace, which, being heated

Fig. 21.

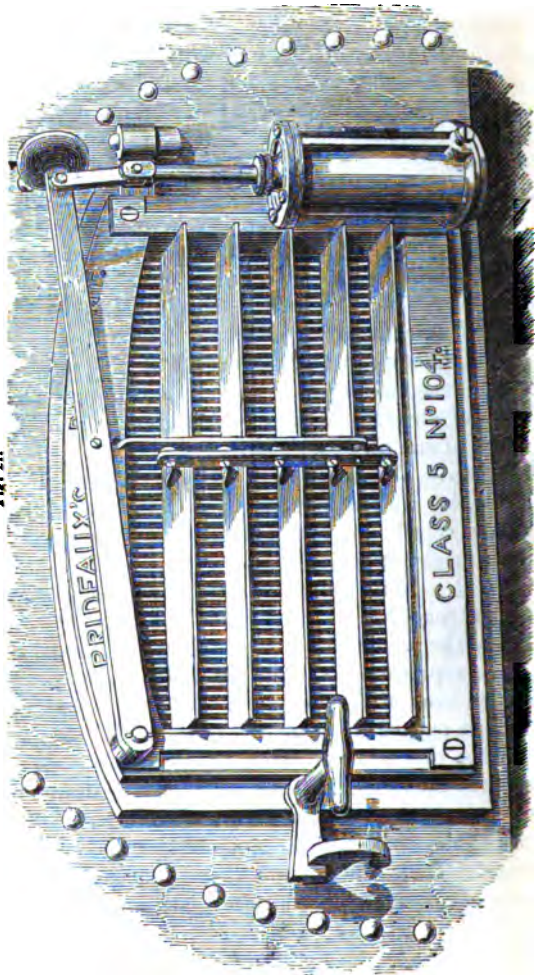

PRIDEAUX'S SELF-CLOSING VALVE FURNACE. Front View, showing furnace door shut.

Fig. 28

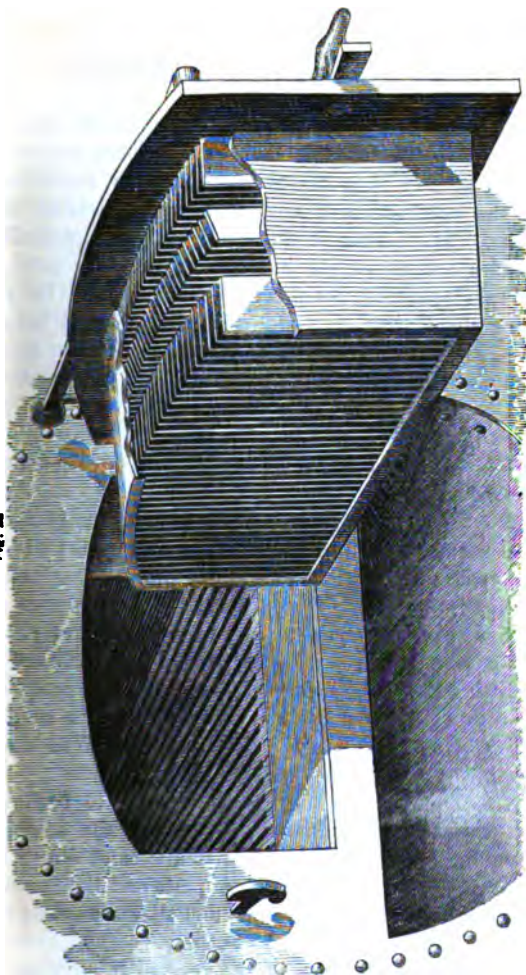

PAIDREUX'S SELF-CLOSING VALVE FURNACE. Front View, showing furnace door open.

in its passage among the numerous heated plates attached to the back of the furnace door, as shown in *fig. 22.*, is in a favourable condition for effecting the combustion of the inflammable parts of the smoke. The piston in the small cylinder gradually subsides and closes the venetians; and the rate of the subsidence of the piston may obviously be regulated by a cock, or, as in this case, a small screw valve, so that the venetians shall just close when there is no more smoke to be consumed;—the air or other fluid within the cylinder being forced out by the piston in its descent.

157. Q.—Had Mr. Watt any method of consuming smoke?

A.—He tried various methods, but eventually fixed upon the method of coking the coal on a dead plate at the furnace door, before pushing it into the fire. That method is perfectly effectual where the combustion is so slow that the requisite time for coking is allowed, and it is much preferable to any of the methods of admitting air at the bridge or elsewhere, to accomplish the combustion of the inflammable parts of the smoke.

158. Q.—What are the details of Mr. Watt's arrangement as now employed?

A.—The fire bars and the dead plate are both set at a considerable inclination, to facilitate the advance of the fuel into the furnace. In Boulton and Watt's 30 horse power land boiler, the dead plate and the furnace bars are both about 4 feet long, and they are set at the angle of 30 degrees with the horizon.

159. Q.—Is the use of the dead plate universally adopted in Boulton and Watt's land boilers?

A.—It is generally adopted, but in some cases Boulton and Watt have substituted the plan of a revolving grate for consuming the smoke, and the dead plate then becomes both superfluous and inapplicable. In this contrivance the fire is replenished with coals by a self-acting mechanism.

160. *Q.*—Will you explain the arrangement of the revolving grate?

A.—The fire grate is made like a round table capable of turning horizontally upon a centre; a shower of coal is precipitated upon the grate through a slit in the boiler near the furnace mouth, and the smoke evolved from the coal dropped at the front part of the fire is consumed by passing over the incandescent fuel at the back part; from which all the smoke must have been expelled in the revolution of the grate before it can have reached that position.

161. *Q.*—Is a furnace with a revolving grate applicable to a steam vessel?

A.—I see nothing to prevent its application. But the arrangement of the boiler would perhaps require to be changed, and it might be preferable to combine its use with the employment of vertical tubes, for the generation of the steam. The introduction of any effectual automatic contrivance for feeding the fire in steam vessels would bring about an important economy, at the same time that it would give the assurance of the work being better done. It is very difficult to fire furnaces by hand effectually at sea, especially in rough weather and in tropical climates; whereas machinery would be unaffected by any such disturbing causes,

and would perform with little expense the work of many men.

162. Q.—The introduction of some mechanical method of feeding the fire with coals would enable a double tier of furnaces to be adopted in steam vessels without inconvenience?

A.—Yes, it would have at least that tendency; and as the space available for area of grate is limited in a steam vessel by the width of the vessel, it would be a great convenience if a double tier of furnaces could be employed without a diminished effect. It appears to me, however, that the objection would still remain of the steam raised by the lower furnace being cooled and deadened by the air entering the ash-pit of the upper fire, for it would strike upon the metal of the ash-pit bottom.

163. Q.—Have any other plans been devised for feeding the fire by self-acting means besides that of a revolving grate?

A.—Yes, many plans, but none of them, perhaps, are free from an objectionable complication. In some arrangements the bars are made like screws, which being turned round slowly, gradually carry forward the coal; while in other arrangements the same object is sought to be attained, by alternately lifting and depressing every second bar at the end nearest the mouth of the furnace. In Juckes' furnace, represented in *fig. 23.*, the fire bars are arranged in the manner of rows of endless chains working over a roller at the mouth of the furnace, and another roller at the further end of the furnace. These rollers are put into slow revolution, and the coal which is deposited at the

mouth of the furnace is gradually carried forward by the motion of the chains which act like an

Fig. 28.

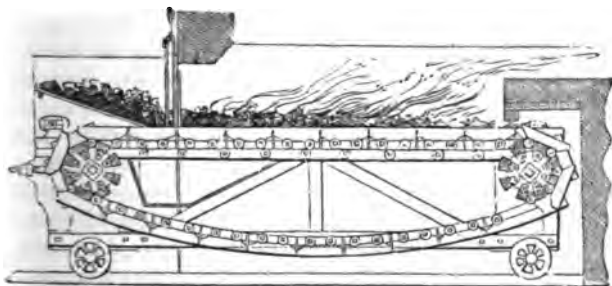

JUCKES' PATENT FURNACE.

endless web. The clinkers and ashes left after the combustion of the coal, are precipitated into the ash-pit, where the chain turns down over the roller at the extremity of the furnace. In Messrs. Maudslays' plan of a self-feeding furnace the fire bars are formed of round tubes, and are placed transversely across the furnace. The ends of the bars gear into endless screws running the whole length of the furnace, whereby motion is given to the bars, and the coal is thus carried gradually forward. It is very doubtful whether any of these contrivances satisfy all the conditions required in a plan for feeding furnaces of the ordinary form by self-acting means, but the problem of providing a suitable contrivance, does not seem difficult of accomplish-

ment, and will no doubt be effected under adequate temptation.

164. *Q.* — Have not many plans been already contrived which consume the smoke of furnaces very effectually?

A. — Yes, many plans; and besides those already mentioned there are Hall's, Coupland's, Godson's, Robinson's, Stevens's, Hazeldine's, Inche's, Bristow and Attwood's, and a great number of others. One plan, which promises well, consists in making the flame descend through the fire bars, and the fire bars are formed of tubes set on an incline and filled with water, which water will circulate with a rapidity proportionate to the intensity of the heat. After all, however, the best remedy for smoke appears to consist in removing from it those portions which form the smoke before the coal is brought into use. Many valuable products may be got from the coal by subjecting it to this treatment; and the residuum will be more valuable than before for the production of steam.

STEAM.

165. *Q.* — Have experiments been made to determine the elasticity of steam at different temperatures?

A. — Yes; very careful experiments. The following rule expresses the results obtained by Mr. Southern: — To the given temperature in degrees of Fahrenheit add 51·3 degrees: from the logarithm of the sum, subtract the logarithm of 135·767, which is 2·1327940; multiply the remainder by 5·13, and to the

natural number answering to the sum, add the constant fraction $\cdot 1$, which will give the elastic force in inches of mercury. If the elastic force be known, and it is wanted to determine the corresponding temperature, the rule must be modified thus:—From the elastic force, in inches of mercury, subtract the decimal $\cdot 1$, divide the logarithm of the remainder by $5\cdot 13$, and to the quotient add the logarithm $2\cdot 1327940$; find the natural number answering to the sum, and subtract therefrom the constant $51\cdot 3$; the remainder will be the temperature sought. The French Academy, and the Franklin Institute, have repeated Mr. Southern's experiments on a larger scale: the results obtained by them are not widely different, and are perhaps nearer the truth, but Mr. Southern's results are generally adopted by engineers, as sufficiently accurate for practical purposes.

166. Q.—Have not some superior experiments upon this subject been made in France by M. Regnault?

A.—Yes, the experiments of M. Regnault upon this subject have been very elaborate and very carefully conducted, and the results are probably more accurate than have been heretofore obtained. Nevertheless, it is questionable how far it is advisable to disturb the rules of Watt and Southern, with which the practice of engineers is very much identified, for the sake of emendations which are not of such magnitude as to influence materially the practical result. M. Regnault has shown that the total amount of heat, existing in a given weight of steam, increases slightly with the pressure, so that the sum of the latent and sensible heats do not form a constant quantity. Thus, in steam

of the atmospheric pressure, or with 14·7 lbs. upon the square inch, the sensible heat of the steam is 212 degrees, the latent heat 966·6 degrees, and the sum of the latent and sensible heats 1178·6 degrees; whereas in steam of 90 pounds upon the square inch the sensible heat is 320·2 degrees, the latent heat 891·4 degrees, and the sum of the latent and sensible heats 1211·0 degrees. There is, therefore, 33 degrees less of heat in any given weight of water, raised into steam of the atmospheric pressure, than if raised into steam of 90 lbs.* pressure.

167. Q.—What expansion does water undergo in its conversion into steam?

A. — A cubic inch of water makes about a cubic foot of steam of the atmospheric pressure.

168. Q.—And how much at a higher pressure?

A. — That depends upon what the pressure is. But the proportion is easily ascertained, for the pressure and the bulk of a given quantity of steam, as of air or any other elastic fluid, are always inversely proportional to one another. Thus if a cubic inch of water makes a cubic foot of steam, with the pressure of one atmosphere, it will make half a cubic foot with the pressure of two atmospheres, a third of a cubic foot with the pressure of three atmospheres, and so on in all other proportions. High pressure steam indeed is just low pressure steam forced into a less space, and the pressure will always be great in the proportion in which the space is contracted.

* A Table containing the results arrived at by M. Regnault is given in the Key.

169. Q.—If this be so, the quantity of heat in a given weight of steam must be nearly the same, whether the steam is high or low pressure?

A.—Yes; the heat in steam is nearly a constant quantity, at all pressures, but not so precisely. Steam to which an additional quantity of heat has been imparted after leaving the boiler, or as it is called “superheated steam,” comes under a different law, for the elasticity of such steam may be increased without any addition being made to its weight; but with the amount of superheating at present employed for working engines, it may be considered in practice that a pound of steam contains very nearly the same quantity of heat at all pressures.

170. Q.—Does not the quantity of heat in any body vary with the temperature?

A.—Other circumstances remaining the same the quantity of heat in a body increases with the temperatures.

171. Q.—And is not high pressure steam hotter than low pressure steam?

A.—Yes, the temperature of steam rises with the pressure.

172. Q.—How then comes it, that there is the same quantity of heat in the same weight of high and low pressure steam, when the high pressure steam has the highest temperature?

A.—Because although the temperature or sensible heat rises with the pressure, the latent heat becomes less in about the same proportion. And as has been already explained, the latent and sensible heats taken together make up nearly the same amount at all tem-

peratures; but the amount is somewhat greater at the higher temperatures. As a damp sponge becomes wet when subjected to pressure, so warm vapour becomes hot when forced into less bulk, but in neither case does the quantity of moisture or the quantity of heat sustain any alteration. Common air becomes so hot by compression that tinder may be inflamed by it, as is seen in the instrument for producing instantaneous light by suddenly forcing air into a syringe.

173. Q.—What law is followed by surcharged steam on the application of heat?

A.—The same as that followed by air, in which the increments in volume are very nearly in the same proportion as the increments in temperature; and the increment in volume for each degree of increased temperature is $\frac{1}{459}$ th part of the volume at 32° . A volume of air which, at the temperature of 32° , occupies 100 cubic feet, will at 212° fill a space of 136.73 cubic feet. The volume which air or steam—out of contact with water—of a given temperature acquires by being heated to a higher temperature, the pressure remaining the same, may be found by the following rule:—To each of the temperatures before and after expansion, add the constant number 459: divide the greater sum by the less, and multiply the quotient by the volume at the lower temperature: the product will give the expanded volume.

174. Q.—If the relative volumes of steam and water are known, is it possible to tell the quantity of water which should be supplied to a boiler, when the quantity of steam expended is specified?

A.—Yes; at the atmospheric pressure, about a cubic inch of water has to be supplied to the boiler for every cubic foot of steam abstracted; at other pressures, the relative bulk of water and steam may be determined as follows:—To the temperature of steam in degrees of Fahrenheit, add the constant number 459, multiply the sum by 37·3, and divide the product by the elastic force of the steam in pounds per square inch; the quotient will give the volume required.

175. *Q.*—Will this rule give the proper dimensions of the pump for feeding the boiler with water?

A.—No; it is necessary in practice that the feed pump should be able to supply the boiler with a much larger quantity of water than what is indicated by these proportions, from the risk of leaks, priming, or other disarrangements, and the feed pump is usually made capable of raising $3\frac{1}{2}$ times the water evaporated by the boiler. About $\frac{1}{240}$ th of the capacity of the cylinder answers very well for the capacity of the feed pump in the case of low pressure engines, supposing the cylinder to be double acting, and the pump single acting; but it is better to exceed this size.

176. *Q.*—Is this rule for the size of the feed pump applicable to the case of high pressure engines?

A.—Clearly not; for since a cylinder full of high pressure steam, contains more water than the same cylinder full of low pressure steam, the size of the pump must vary in the same proportion as the density of the steam. In all pumps a good deal of the effect is lost from the imperfect action of the valves; and in engines travelling at a high rate of speed, in parti-

cular, a large part of the water is apt to return through the suction valve of the pump, especially if much lift be permitted to that valve. In steam vessels moreover, where the boiler is fed with salt water, and where a certain quantity of supersalted water has to be blown out of the boiler from time to time, to prevent the water from reaching too high a degree of concentration, the feed pump requires to be of additional size to supply the extra quantity of water thus rendered necessary. When the feed water is boiling or very hot, as in some engines is the case, the feed pump will not draw from a depth, and will altogether act less efficiently, so that an extra size of pump has to be provided in consequence. These and other considerations which might be mentioned show the propriety of making the feed pump very much larger than theory requires. The proper proportions of pumps, however, forms part of a subsequent chapter.

CHAP. III.

EXPANSION OF STEAM AND ACTION OF THE
VALVES.

177. Q.—What is meant by working engines expansively?

A.—Adjusting the valves, so that the steam is shut off from the cylinder before the end of the stroke, whereby the residue of the stroke is left to be completed by the expanding steam.

178. Q.—And what is the benefit of that practice?

A.—It accomplishes an important saving of steam, or, what is the same thing, of fuel; but it diminishes the power of the engine, while increasing the power of the steam. A larger engine will be required to do the same work, but the work will be done with a smaller consumption of fuel. If, for example, the steam be shut off when only half the stroke is completed, there will only be half the quantity of steam used. But there will be more than half the power exerted; for although the pressure of the steam decreases after the supply entering from the boiler is shut off, yet it imparts, during its expansion, *some* power, and that power, it is clear, is obtained without any expenditure of steam or fuel whatever.

179. *Q.* — What will be the pressure of the steam, under such circumstances, at the end of the stroke?

A. — If the steam be shut off at half stroke, the pressure of the steam, reckoning the total pressure both below and above the atmosphere, will just be one-half of what it was at the beginning of the stroke. It is a well known law of pneumatics, that the pressure of elastic fluids varies inversely as the spaces into which they are expanded or compressed. For example, if a cubic foot of air of the atmospheric density be compressed into the compass of half a cubic foot, its elasticity will be increased from 15 lbs. on the square inch to 30 lbs. on the square inch; whereas, if its volume be enlarged to two cubic feet, its elasticity will be reduced to $7\frac{1}{2}$ lbs. on the square inch, being just half its original pressure. The same law holds in all other proportions, and with all other gases and vapours, provided their temperature remains unchanged; and if the steam valve of an engine be closed, when the piston has descended through one-fourth of the stroke, the steam within the cylinder will, at the end of the stroke, just exert one-fourth of its initial pressure.

180. *Q.* — Then by computing the varying pressure at a number of stages, the average or mean pressure throughout the stroke may be approximately determined?

A. — Precisely so. Thus, in the accompanying figure, *fig. 24.*, let *E* be a cylinder, *J* the piston, *a* the steam pipe, *c* the upper port, *f* the lower port, *d* the steam pipe, prolonged to *e* the equilibrium valve, *g* the eduction valve, *M* the steam jacket, *N* the cylinder

Fig. 24.

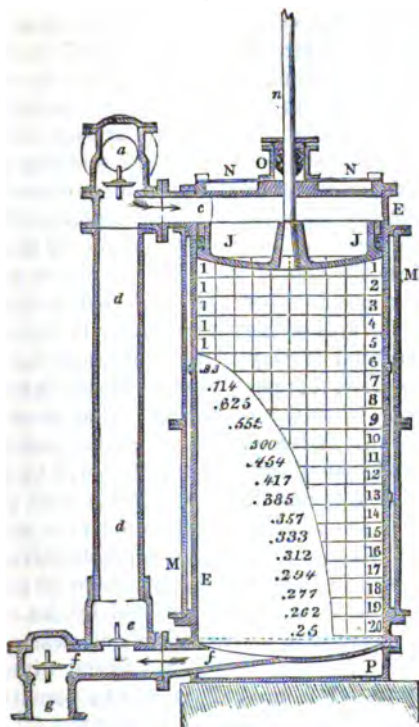

Diagram showing law of expansion of steam in a cylinder.

cover, O stuffing box, *n* piston rod, P cylinder bottom ; let the cylinder be supposed to be divided in the direction of its length into any number of equal parts, any twenty, and let the diameter of the cylinder re-

present the pressure of the steam, which, for the sake of simplicity, we may take at 10 lbs., so that we may divide the cylinder, in the direction of its diameter, into ten equal parts. If now the piston be supposed to descend through five of the divisions, and the steam valve then be shut, the pressure at each subsequent position of the piston will be represented by a series, computed according to the laws of pneumatics, and which, if the initial pressure be represented by 1, will give a pressure of $\cdot 5$ at the middle of the stroke, and $\cdot 25$ at the end of it. If this series be set off on the horizontal lines, it will mark out a hyperbolic curve—the area of the part exterior to which represents the total efficacy of the stroke, and the interior area, therefore, represents the diminution in the power of a stroke, when the steam is cut off at one-fourth of the descent. If the squares above the point, where the steam is cut off, be counted, they will be found to amount to 50; and if those beneath that point be counted or estimated, they will be found to amount to about 69. These squares are representative of the power exerted; so that while an amount of power represented by 50 has been obtained by the expenditure of a quarter of a cylinder full of steam, we get an amount of power represented by 69, without any expenditure of steam at all, merely by permitting the steam first used to expand into four times its original volume.

181. *Q.*—Then by working an engine expansively, the power of the steam is increased, but the power of the engine is diminished?

A.—Yes. The efficacy of a given quantity of

steam is more than doubled by expanding the steam four times, while the efficacy of each stroke is made nearly one-half less. And, therefore, to carry out the expansive principle in practice, the cylinder requires to be larger than usual, or the piston faster than usual, in the proportion in which the expansion is carried out. Every one who is acquainted with simple arithmetic, can compute the terminal pressure of steam in a cylinder, when he knows the initial pressure and the point at which the steam is cut off; and he can also find, by the same process, any pressure intermediate between the first and last. By setting down these pressures in a table, and taking their mean, he can determine the effect, with tolerable accuracy, of any particular measure of expansion. It is necessary to remark, that it is the total pressure of the steam that he must take; not the pressure above the atmosphere, but the pressure above a perfect vacuum.

182. Q.—Can you give any rule for ascertaining at one operation the amount of benefit derivable from expansion?

A.—Divide the length of stroke through which the steam expands, by the length of stroke performed with full pressure, which last call 1; the hyperbolic logarithm of the quotient is the increase of efficiency due to expansion. According to this rule it will be found, that if a given quantity of steam, the power of which working at full pressure is represented by 1, be admitted into a cylinder of such a size that its ingress is concluded when one-half the stroke has been performed, its efficacy will be raised by expansion to 1.69; if the admission of the steam be stopped at one-

third of the stroke, the efficacy will be 2·10; at one-fourth 2·89; at one-fifth 2·61; at one-sixth, 2·79; at one-seventh 2·95; at one-eighth 3·08. The expansion, however, cannot be carried beneficially so far as one-eighth, unless the pressure of the steam in the boiler be very considerable, on account of the inconvenient size of cylinder or speed of piston which would require to be adopted, the friction of the engine, and the resistance of vapour in the condenser, which all become relatively greater with a smaller urging force.

183. Q.—Is this amount of benefit actually realised in practice?

A.—Only in some cases. It appears to be indispensable to the realisation of any large amount of benefit by expansion, that the cylinder should be enclosed in a steam jacket, or should in some other way be effectually protected from refrigeration. In some engines not so protected, it has been found experimentally that less benefit was obtained from the fuel by working expansively than by working without expansion—the whole benefit due to expansion being more than counteracted by the increased refrigeration due to the larger surface of the cylinder required to develop the power. In locomotive engines, with outside cylinders, this condition of the advantageous use of expansion has been made very conspicuous, as has also been the case in screw steamers with four cylinders, and in which the refrigerating surface of the cylinders was consequently large.

184. Q.—The steam is admitted to and from the cylinder by means of a slide or sluice valve?

A.—Yes; and of the slide valve there are many

varieties; but the kinds most in use are the D valve, shown in *fig. 25.*, — and so called from its resemblance to a half cylinder or D in its cross section — and the three ported valve, shown in *fig. 26.*, which consists

Fig. 25.



LONG D VALVE.

Fig. 26.

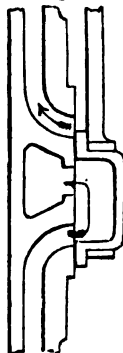

THREE PORTED VALVE.

of a brass or iron box set over the two ports or openings into the cylinder, and a central port which conducts away the steam to the atmosphere or condenser; but the length of the box is so adjusted that it can only cover one of the cylinder ports and the central or eduction port at the same time. The effect, therefore, of moving the valve up and down, as is done by the eccentric, is to establish a connection alternately between each cylinder port and the central passage whereby the steam escapes; and while the steam is escaping from beneath the piston, the position of the

valve is such, that a free communication exists between the space above the piston and the steam in the boiler. The piston is thus urged alternately up and down — the valve so changing its position before the piston arrives at the end of the stroke, that the pressure is by that time thrown on the reverse side of the piston, so as to urge it into motion in the opposite direction.

185. *Q.* — Is the motion of the valve, then, the reverse of that of the piston ?

A. — No. The valve does not move down when the piston moves down, nor does it move down when the piston moves up ; but it moves from its mid position to the extremity of its throw and back again to its mid position, while the piston makes an upward or downward movement, so that the motion is as it were at right angles to the motion of the piston ; or it is the same motion that the piston of another engine, the crank of which is set at right angles with that of the first engine, would acquire.

186. *Q.* — Then in a steam vessel the valve of one engine may be worked from the piston of the other ?

A. — Yes, it may ; or it may be worked from its own connecting rod ; and in the case of locomotive engines, this has sometimes been done.

187. *Q.* — What is meant by the lead of the valve ?

A. — The amount of opening which the valve presents for the admission of the steam, when the piston is just beginning its stroke. It is found expedient that the valve should have opened a little to admit steam on the reverse side of the piston before the stroke terminates ; and the amount of this opening,

which is given by turning the eccentric more or less round upon the shaft, is what is termed the lead.

188. *Q.* — And what is meant by the lap of the valve?

A. — It is an elongation of the valve face to a certain extent over the port, whereby the port is closed sooner than would otherwise be the case. This extension is chiefly effected at that part of the valve where the steam is admitted, or upon the *steam side* of the valve, as the technical phrase is; and the intent of the extension is to close the steam passage before the end of the stroke, whereby the engine is made to operate to a certain extent expansively. In some cases, however, there is also a certain amount of lap given to the escape or eduction side, to prevent the eduction from being performed too soon when the lead is great; but in all cases there is far less lap on the eduction than on the steam side, very often there is none, and sometimes less than none, so that the valve is incapable of covering both the ports at once.

189. *Q.* — What is the usual proportional length of stroke of the valve?

A. — The common stroke of the valve in rotative engines is twice the breadth or depth of the port, and the length of the valve face will then be just the breadth of the port when there is lap on neither the steam nor eduction side. Whatever lap is given, therefore, makes the valve face just so much longer. In some engines, however, the stroke of the valve is a good deal more than twice the breadth of the port; and it is to the stroke of the valve that the amount of lap should properly be referred.

190. Q.— Can you tell what amount of lap will accomplish any given amount of expansion?

A.— Yes, when the stroke of the valve is known. From the length of the stroke of the piston subtract that part of the stroke which is intended to be accomplished before the steam is cut off; divide the remainder by the length of the stroke of the piston, and extract the square root of the quotient, which multiply by half the stroke of the valve, and from the product take half the lead; the remainder will be the lap required.

191. Q.— Can you state how we may discover at what point of the stroke the eduction passage will be closed?

A.— To find how much before the end of the stroke the eduction passage will be closed:— to the lap on the steam side add the lead, and divide the sum by half the stroke of the valve; find the arc whose sine is equal to the quotient, and add 90° to it; divide the lap on the eduction side by half the stroke of the valve, and find the arc whose cosine is equal to the quotient; subtract this arc from the one last obtained, and find the cosine of the remainder; subtract this cosine from 2, and multiply the remainder by half the stroke of the piston; the product is the distance of the piston from the end of the stroke when the eduction passage is closed.

192. Q.— Can you explain how we may determine the distance of the piston from the end of the stroke, before the steam urging it onward is allowed to escape?

A.— To find how far the piston is from the end of its stroke when the steam that is propelling it by

expansion is allowed to escape to the atmosphere or condenser:—to the lap on the steam side add the lead; divide the sum by half the stroke of the valve, and find the arc whose sine is equal to the quotient; find the arc whose sine is equal to the lap on the eduction side, divided by half the stroke of the valve; add these two arcs together and subtract 90° ; find the cosine of the residue, subtract it from 1, and multiply the remainder by half the stroke of the piston; the product is the distance of the piston from the end of its stroke when the steam that is propelling it is allowed to escape into the atmosphere or condenser. In using these rules, all the dimensions are to be taken in inches, and the answers will be found in inches also.

193. *Q.*—Is it a benefit or a detriment to open the eduction passage before the end of the stroke?

A.—In engines working at a high rate of speed, such as locomotive engines, it is very important to open the exhaust passage for the escape of the steam before the end of the stroke, as an injurious amount of back pressure is thus prevented. In the earlier locomotives a great loss of effect was produced from inattention to this condition; and when lap was applied to the valves to enable the steam to be worked expansively, it was found that a still greater benefit was collaterally obtained by the earlier escape of the steam from the eduction passages, and which was incidental to the application of lap to the valves. The average consumption of coke per mile was reduced by Mr. Woods from 40 lbs. per mile to 15 lbs per mile, chiefly by giving a free outlet to the escaping steam.

194. Q.—To what extent can expansion be carried beneficially by means of lap upon the valve?

A.—To about one-third of the stroke; that is, the valve may be made with so much lap, that the steam will be cut off when two-thirds of the stroke have been performed, leaving the residue to be accomplished by the agency of the expanding steam; but if a much further amount of expansion than this is wanted, it may be accomplished by wire drawing the steam, or by so contracting the steam passage that the pressure within the cylinder must decline when the speed of the piston is accelerated, as it is about the middle of the stroke.

195. Q.—Will you explain how this result ensues?

A.—If the valve be so made as to shut off the steam by the time two thirds of the stroke have been performed, and the steam be at the same time throttled in the steam pipe, the full pressure of the steam within the cylinder cannot be maintained except near the beginning of the stroke, where the piston travels slowly; for, as the speed of the piston increases, the pressure necessarily subsides, until the piston approaches the other end of the cylinder, where the pressure would rise again but that the operation of the lap on the valve by this time has had the effect of closing the communication between the cylinder and steam pipe, so as to prevent more steam from entering. By throttling the steam, therefore, in the manner here indicated, the amount of expansion due to the lap may be doubled, so that an engine with lap enough upon the valve to cut off the steam at two-thirds of the stroke, may, by the aid of wire drawing,

be virtually rendered capable of cutting off the steam at one-third of the stroke.

196. Q.—Is this the usual way of cutting off the steam?

A.—No; the usual manner of cutting off the steam is by means of a separate valve, termed an expansion valve; but such a device appears to be hardly necessary in ordinary engines, especially if fitted with the link motion, by which a very efficient expansive action of the steam is obtainable by shortening the throw of the valve, which virtually increases the lap. In the Cornish engines, where the steam is cut off in some cases at one-twelfth of the stroke, a separate valve for the admission of steam, other than that which permits its escape, is nearly indispensable; but in common rotative engines a separate expansion valve does not appear to be required.

197. Q.—That is, where much expansion is required an expansion valve is a proper appendage, but where not much is required a separate expansion valve may be dispensed with.

A.—Precisely so. The wire drawing of the steam causes a loss of part of its power, and the result will not be quite so advantageous by throttling as by cutting off. But for moderate amounts of expansion it will suffice, provided there be lap upon the slide valve.

198. Q.—Will you explain the structure or configuration of expansion apparatus of the usual construction?

A.—The structure of expansion apparatus is very various; but all the kinds operate either on the

principle of giving such a motion to the slide valve as will enable it to cut off the steam at the desired point, or on the principle of shutting off the steam by a separate valve in the steam pipe or valve casing. The first class of apparatus has not been found so manageable, and is not in extensive use, except in that form known as the link motion. Of the second class, the most simple probably is the application of a cam, giving motion to the throttle valve, or to a valve of the same construction, which either accurately fits the steam pipe, or which comes round to a face, which, however, it is restrained from touching by a suitable construction of the cam. A kind of expansion valve, often employed in marine engines of low speed, is the kind used in the Cornish engines, and known as the

equilibrium valve. This valve is represented in *fig. 27*. It consists substantially of an annulus or bulging cylinder of brass, with a steam-tight face both at its upper and lower edges, at which points it fits accurately upon a stationary seat. This annulus may be raised or lowered without being resisted by the pressure of the steam, and

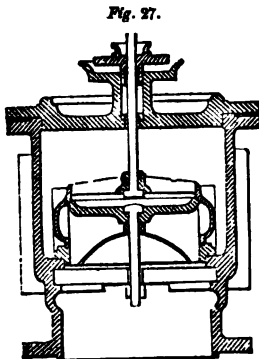

CORNISH EQUILIBRIUM VALVE.

in rotative engines it is usually worked by a cam on the shaft. The expansion cam is put on the shaft

in two pieces, which are fastened to each other by means of four bolts passing through lugs, and is fixed to the shaft by keys. A roller at one end of a bell-crank lever, which is connected with the expansion valve, presses against the cam, so that the motion of the lever will work the valve. The roller is kept against the cam by a weight on a lever attached to the same shaft, but a spring is necessary for high speeds. If the cam were concentric with the shaft, the lever which presses upon it would remain stationary, and also the expansion valve; but by the projection of the cam, the end of the lever receives a reciprocating motion, which is communicated to the valve.

199. Q.—The cam then works the valve?

A.—Yes. The position of the projection of the cam determines the point in relation to the stroke at which the valve is opened, and its circumferential length determines the length of the time during which the valve continues open. The time at which the valve should begin to open is the same under all circumstances, but the duration of its opening varies with the amount of expansion desired. In order to obtain this variable extent of expansion, there are several projections made upon the cam, each of which gives a different degree, or *grade* as it is usually called, of expansion. These grades all begin at the same point on the cam, but are of different lengths, so that they begin to move the lever at the same time, but differ in the time of returning it to its original position.

200. Q.—How is the degree of expansion changed?

A.—The change of expansion is effected by moving the roller on to the desired grade; which is done by

slipping the lever carrying the roller endways on the shaft or pin sustaining it.

201. Q.—Are such cams applicable in all cases?

A.—In engines moving at a high rate of speed the roller will be thrown back from the cam by its momentum, unless it be kept against it by means of springs. In some cases I have employed a spring formed of a great number of discs of India rubber to keep the roller against the cam, but on the whole a small vacuum cylinder appears to be the kind of spring least liable to derangement.

202. Q.—May not the percussion incident to the action of a cam at a high speed, when the roller is not kept up to the face by springs, be obviated by giving a suitable configuration to the cam itself?

A.—It may at all events be reduced. The outline of the cam should be a parabola, so that the valve may be set in motion precisely as a falling body would be; but it will, nevertheless, be necessary that the roller on which the cam presses should be forced upward by a spring rather than by a counterweight, as there will thus be less inertia or momentum in the mass that has to be moved.

203. Q.—An additional slide valve is sometimes used for cutting off the steam?

A.—Yes, very frequently; and the slide valve is sometimes on the side or back of the valve casing, and sometimes on the back of the main or distributing valve, and moving with it.

204. Q.—Are cams used in locomotive engines?

A.—In locomotive engines the use of cams is inadmissible, and other expedients are employed. of

which those contrived by Stephenson and by Cabrey operate on the principle of accomplishing the requisite variations of expansion by altering the throw of the slide valve.

205. Q.—What is Stephenson's arrangement?

A.—Stephenson connects the ends of the forward and backward eccentric rods by a link with a curved slot in which a pin upon the end of the valve rod works. By moving this link so as to bring the forward eccentric rod in the same line with the valve rod, the valve receives the motion due to that eccentric; whereas if the backward eccentric rod is brought in a line with the valve rod, the valve gets the motion proper for reversing, and if the link be so placed that the valve rod is midway between the two eccentric rods, the valve will remain nearly stationary. This arrangement, which is now employed extensively, is what is termed "the link motion." It is represented in the annexed figure, *fig.* 28., where *e* is the valve rod, which is attached by a pin to an open curved link susceptible of being moved up and down by the ball-crank lever *f'' f''*, supported on the centre *g*, and acting on the links *f*, while the valve rod *e* remains in the same horizontal plane; *d d'* are the eccentric rods, and the link is represented in its lowest position. The dotted lines *h' h''* show the position of the eccentric rods when the link is in its highest position, and *ll'* when in mid position.

206. Q.—What is Cabrey's arrangement?

A.—Mr. Cabrey makes his eccentric rod terminate in a pin which works into a straight slotted lever, furnished with jaws similar to the jaws on the eccen-

tric rods of locomotives. By raising the pin of the eccentric rod in this slot, the travel of the valve will be varied, and expansive action will be the result.

Fig. 23.

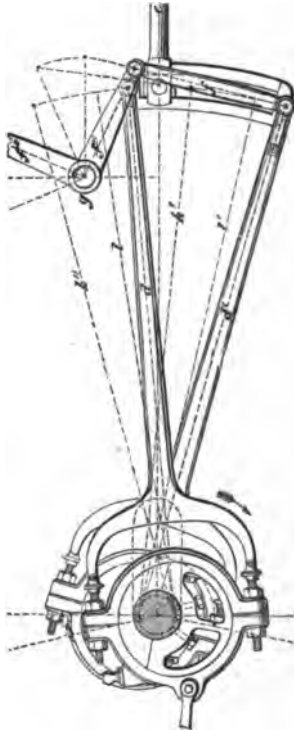

STEPHENSON'S LINK MOTION.

207. Q.—What other forms of apparatus are there for working steam expansively?

A. — They are too numerous for description here, but a few of them may be enumerated. Fenton seeks to accomplish the desired object by introducing a spiral feather on the crank axle, by moving the eccentric laterally against which the eccentric is partially turned round so as to cut off the steam at a different part of the stroke. Dodds seeks to attain the same end by corresponding mechanical arrangements. Farcot, Edwards, and Lavagrian cut off the steam by the application of a supplementary valve at the back of the ordinary valve, which supplementary valve is moved by tappets fixed to the valve casing. Bodmer in 1841, and Meyer in 1842, employed two slides or blocks fitted over apertures in the ordinary slide valve, and which blocks were approximated or set apart by a right and left handed screw passing through both.* Hawthorn, in 1843, employed as an

* In 1838 I patented an arrangement of expansion valve, consisting of two movable plates set upon the ordinary slide valve, and which might be drawn together or asunder by means of a right and left handed screw passing through both plates. The valve spindle was hollow, and a prolongation of the screw passed up through it, and was armed on the top with a small wheel, by means of which the plates might be adjusted while the engine was at work. In 1839 I fitted an expansion valve in a steam vessel, consisting of two plates, connected by a rod, and moved by tappets up against the steam edges of the valve. In another steam vessel I fitted the same species of valve, but the motion was not derived from tappets, but from a moving part of the engine, though at the moderate speed at which these engines worked I found tappets to operate well and make little noise. In 1837 I employed, as an expansion valve, a rectangular throttle valve, accurately fitting a bored out seat, in which it might be made to revolve, though it did not revolve in working. This valve was moved by a pin in a pinion, making two revolutions for every revolution of the engine, and the configuration of the seat determined the amount of the expansion. In 1855 I

expansion valve a species of frame lying on the ordinary cylinder face upon the outside of the valve, and working up against the steam side of the valve at each end so as to cut off the steam. In the same year Gonzenbach patented an arrangement which consists of an additional slide valve and valve casing placed on the back of the ordinary slide valve casing, and through this supplementary valve the steam must first pass. This supplementary valve is worked by a double ended lever, slotted at one end for the reception of a pin on the valve link, the position of which in the slot determines the throw of the supplementary valve, and the consequent degree of expansion.

208. Q.—What is the arrangement of expansion valve used in the most approved modern engines?

A.—In modern engines, either marine or locomotive, it is found that if they are fitted with the link motion, as they nearly all are, a very good expansive action can be obtained by giving a suitable adjustment to it, without employing an expansion valve at all. Diagrams taken from engines worked in this manner show a very excellent result, and most of the modern engines trust for their expansive working to the link motion and the throttle valve.

have again used expansion valves of this construction in engines making 100 revolutions per minute, and with perfectly satisfactory results.—J. B.

CHAP. IV.

MODES OF ESTIMATING THE POWER AND PERFORMANCE OF ENGINES AND BOILERS.

HORSES POWER.

209. *Q.*—What do you understand by a horse power?

A.—An amount of mechanical force that will raise 33,000 lbs. one foot high in a minute. This standard was adopted by Mr. Watt, as the average force exerted by the strongest London horses; the object of his investigation being to enable him to determine the relation between the power of a certain size of engine and the power of a horse, so that when it was desired to supersede the use of horses by the erection of an engine, he might, from the number of horses employed, determine the size of engine that would be suitable for the work.

210. *Q.*—Then, when we talk of an engine of 200 horse power, it is meant that the impelling efficacy is equal to that of 200 horses, each lifting 33,000 lbs. one foot high in a minute?

A.—No, not now; such was the case in Watt's engines, but the capacity of cylinder answerable to a

horse power has been increased by most engineers since his time, and the pressure on the piston has been increased also, so that what is now called a 200 horse power engine exerts, almost in every case, a greater power than was exerted in Watt's time, and a horse power, in the popular sense of the term, has become a mere conventional unit for expressing a certain size of engine, without reference to the power exerted.

211. Q. — Then each nominal horse power of a modern engine may raise much more than 33,000 lbs. one foot high in a minute?

A. — Yes; some raise 52,000 lbs., others 60,000 lbs., and others 66,000 lbs., one foot high in the minute by each nominal horse power. Some engines indeed work as high as eight times above the nominal power, and therefore no comparison can be made between the performances of different engines, unless the power actually exerted be first discovered.

212. Q. — How is the power actually exerted by engines ascertained?

A. — By means of an instrument called the indicator, which is a miniature cylinder and piston attached to the cylinder cover of the main engine, and which indicates, by the pressure exerted on a spring, the amount of pressure or vacuum existing within the cylinder. From this pressure, expressed in pounds per square inch, deduct a pound and a half of pressure for friction, the loss of power in working the air pump, &c.; multiply the area of the piston in square inches by this residual pressure, and by the motion of the piston, in feet per minute, and divide by 33,000;

the quotient is the actual number of horses power of the engine. The same result is attained by squaring the diameter of the cylinder, multiplying by the pressure per square inch, as shown by the indicator, less a pound and a half, and by the motion of the piston, in feet per minute, and dividing by 42,017.

213. Q. — How is the nominal power of an engine ascertained?

A. — Since the nominal power is a mere conventional expression, it is clear that it must be determined by a merely conventional process. The nominal power of ordinary condensing engines may be ascertained by the following rule: multiply the square of the diameter of the cylinder in inches, by the velocity of the piston in feet per minute, and divide the product by 6000; the quotient is the number of nominal horses power. In using this rule, however, it is necessary to adopt the speed of piston prescribed by Mr. Watt, which varies with the length of the stroke. The speed of piston with a 2 feet stroke is, according to his system, 160 per minute; with a 2 ft. 6 in. stroke, 170; 3 ft., 180; 3 ft. 6 in., 189; 4 ft., 200; 5 ft., 215; 6 ft., 228; 7 ft., 245; 8 ft., 256 ft.

214. Q. — Does not the speed of the piston increase with the length of the stroke?

A. — It does: the speed of the piston varies nearly as the cube root of the length of the stroke.

215. Q. — And may not therefore some multiple of the cube root of the length of the stroke be substituted for the velocity of the piston in determining the nominal power?

A. — The substitution is quite practicable, and will

accomplish some simplification, as the speed of piston proper for the different lengths of stroke cannot always be remembered. The rule for the nominal power of condensing engines when thus arranged will be as follows : multiply the square of the diameter of the cylinder in inches by the cube root of the stroke in feet, and divide the product by 47 ; the quotient is the number of nominal horses power of the engine, supposing it to be of the ordinary condensing description. This rule assumes the existence of a uniform effective pressure upon the piston of 7 lbs. per square inch ; Mr. Watt estimated the effective pressure upon the piston of his 4 horse power engines at 6·8 lbs. per square inch, and the pressure increased slightly with the power, and became 6·94 lbs. per square inch in engines of 100 horse power ; but it appears to be more convenient to take a uniform pressure of 7 lbs. for all powers. Small engines, indeed, are somewhat less effective in proportion than large ones, but the difference can be made up by slightly increasing the pressure in the boiler ; and small boilers will bear such an increase without inconvenience.

216. Q.—How do you ascertain the power of high pressure engines ?

A.—The actual power is readily ascertained by the indicator, by the same process by which the actual power of low pressure engines is ascertained. The friction of a locomotive engine when unloaded is found by experiment to be about 1 lb. per square inch on the surface of the pistons, and the additional friction caused by any additional resistance is estimated at about ·14 of that resistance ; but it will be

a sufficiently near approximation to the power consumed by friction in high pressure engines, if we make a deduction of a pound and a half from the pressure on that account, as in the case of low pressure engines. High pressure engines, it is true, have no air pump to work ; but the deduction of a pound and a half of pressure is relatively a much smaller one where the pressure is high, than where it does not much exceed the pressure of the atmosphere. The rule, therefore, for the actual horse power of a high pressure engine will stand thus: square the diameter of the cylinder in inches, multiply by the pressure of the steam in the cylinder per square inch less $1\frac{1}{2}$ lb., and by the speed of the piston in feet per minute, and divide by 42,017 ; the quotient is the actual horse power.

217. Q. — But how do you ascertain the nominal horse power of high pressure engines ?

A. — The nominal horse power of a high pressure engine has never been defined ; but it should obviously hold the same relation to the actual power as that which obtains in the case of condensing engines, so that an engine of a given nominal power may be capable of performing the same work, whether high pressure or condensing. This relation is maintained in the following rule, which expresses the nominal horse power of high pressure engines : multiply the square of the diameter of the cylinder in inches by the cube root of the length of stroke in feet, and divide the product by 15.6. This rule gives the nominal power of a high pressure engine three times greater than that of a low pressure engine of the

same dimensions; the average effective pressure being taken at 21 lbs. per square inch instead of 7 lbs., and the speed of the piston in feet per minute being in both rules 128 times the cube root of the length of stroke.*

218. Q. — Is 128 times the cube root of the stroke in feet per minute the ordinary speed of all engines?

A. — Locomotive engines travel at a quicker speed, — an innovation brought about not by any process of scientific deduction, but by the accidents and exigencies of railway transit. Most other engines, however, travel at about the speed of 128 times the cube root of the stroke in feet; but some marine condensing engines of recent construction travel at as high a rate as 700 feet per minute. To mitigate the shock of the air pump valves in cases in which a high speed has been desirable, as in the case of marine engines employed to drive the screw propeller without intermediate gearing, India rubber discs, resting on a perforated metal plate, are now generally adopted; but the India rubber should be very thick, and the guards employed to keep the discs down should be of the same diameter as the discs themselves.

219. Q. — Can you suggest any eligible method of enabling condensing engines to work satisfactorily at a high rate of speed?

A. — The most feasible way of enabling condensing engines to work satisfactorily at a high speed, appears to lie in the application of balance weights to the

* Tables of the horse power of both high and low pressure engines are given in the Key.

engine, so as to balance the momentum of its moving parts, and the engine must also be made very strong and rigid. It appears to be advisable to perform the condensation partly in the air pump, instead of altogether in the condenser, as a better vacuum and a superior action of the air pump valves will thus be obtained. Engines constructed upon this plan may be driven at four times the speed of common engines, whereby an engine of large power may be purchased for a very moderate price, and be capable of being put into a very small compass; while the motion, from being more equable, will be better adapted for most purposes for which a rotary motion is required. Even for pumping mines and blowing iron furnaces, engines of this kind appear likely to come into use, for they are more suitable than other engines for driving the centrifugal pump, which in many cases appears likely to supersede other kinds of pumps for lifting water; and they are also conveniently applicable to the driving of fans, which, when so arranged that the air condensed by one fan is employed to feed another, and so on through a series of 3 or 4, have succeeded in forcing air into a furnace with a pressure of $2\frac{1}{2}$ lbs. on the square inch, and with a far steadier flow than can be obtained by a blast engine with any conceivable kind of compensating apparatus. They are equally applicable if blast cylinders be employed.

220. Q. — Then, if by this modification of the engine you enable it to work at four times the speed, you also enable it to exert four times the power?

A. — Yes; always supposing it to be fully supplied

with steam. The nominal power of this new species of engine can readily be ascertained by taking into account the speed of the piston, and this is taken into account by the Admiralty rule for power.

221. Q. — What is the Admiralty rule for determining the power of an engine ?

A. — Square the diameter of the cylinder in inches, which multiply by the speed of the piston in feet per minute, and divide by 6000 ; the quotient is the power of the engine by Admiralty rule.*

222. Q. — The high speed engine does not require so heavy a fly wheel as common engines ?

A. — No : the fly wheel will be lighter, both by virtue of its greater velocity of rotation, and because the impulse communicated by the piston is less in amount and more frequently repeated, so as to approach more nearly to the condition of a uniform pressure.

223. Q. — Can nominal be transformed into actual horse power ?

A. — No ; that is not possible in the case of common condensing engines. The actual power exerted by an engine cannot be deduced from its nominal power, neither can the nominal power be deduced from the power actually exerted, or from anything else than the dimensions of the cylinder. The actual horse power being a dynamical unit, and the nominal horse

* *Example.*—What is the power of an engine of 42 inches diameter, $3\frac{1}{2}$ feet stroke, and making 85 strokes per minute ? The speed of the piston will be 7 (the length of a double stroke) \times 85 = 595 feet per minute. Now $42 \times 42 = 1764 \times 595 = 1,049,580 \div 6000 = 175$ horses power.

power a measure of capacity of the cylinder, are obviously incomparable things.

224. Q.—That is, the *nominal* power is a commercial unit by which engines are bought and sold, and the *actual* power a scientific unit by which the quality of their performance is determined?

A. — Yes ; the nominal power is as much a commercial measure as a yard or a bushel, and is not a thing to be ascertained by any process of science, but to be fixed by authority in the same manner as other measures. The actual power, on the contrary, is a mechanical force or dynamical effort capable of raising a given weight through a given distance in a given time, and of which the amount is ascertainable by scientific investigation.

225. Q.—Is there any other measure of an actual horse power than 33,000 lbs. raised one foot high in the minute?

A. — There cannot be any *different* measure, but there are several equivalent measures. Thus the evaporation of a cubic foot of water in the hour, or the expenditure of 33 cubic feet of low pressure steam per minute, is reckoned equivalent to an actual horse power, or 528 cubic feet of water raised one foot high in the minute involves the same result.

DUTY OF ENGINES AND BOILERS.

226. Q.—What is meant by the duty of an engine?

A.—The work done in relation to the fuel consumed.

227. Q.—And how is the duty ascertained?

A.—In ordinary mill or marine engines it can only be ascertained by the indicator, as the load upon such engines is variable, and cannot readily be determined; but in the case of engines for pumping water, where the load is constant, the number of strokes performed by the engine will represent the work done, and the amount of work done by a given quantity of coal represents the duty. In Cornwall the duty of an engine is expressed by the number of millions of pounds raised one foot high by a bushel, or 94 lbs. of Welsh coal. A bushel of Newcastle coal will only weigh 84 lbs.; and in comparing the duty of a Cornish engine with the performance of an engine in some locality where a different kind of coal is used, it is necessary to pay regard to such variations.

228. *Q.*—Can you tell the duty of an engine when you know its consumption of coal per horse power per hour?

A.—Yes, if the power given be the actual, and not the nominal, power. Divide 166.32 by the number of pounds of coal consumed per actual horse power per hour; the quotient is the duty in millions of pounds. If you already have the duty in millions of pounds, and wish to know the equivalent consumption in pounds per actual horse power per hour, divide 166.32 by the duty in millions of pounds; the quotient is the consumption per actual horse power per hour. The duty of a locomotive engine is expressed by the weight of coke it consumes in transporting a ton through the distance of one mile upon a railway; but this is a very imperfect method of representing the duty, as the tractive efficacy of a pound of coke becomes less as the

speed of the locomotive becomes greater ; and the law of variation is not accurately known.

229. *Q.* — What amount of power is generated in good engines of the ordinary kind by a given weight of coal ?

A. — The duty of different kinds of engines varies very much, and there are also great differences in the performance of different engines of the same class. In ordinary rotative condensing engines of good construction, 10 lbs. of coal per nominal horse power per hour is a common consumption ; but such engines exert nearly twice their nominal power, so that the consumption per actual horse power per hour may be taken at from 5 to 6 lbs. Engines working very expansively, however, attain an economy much superior to this. The average duty of the pumping engines in Cornwall is about 60,000,000 lbs. raised 1 ft. high by a bushel of Welsh coals, which weighs 94 lbs. This is equivalent to a consumption of 3.1 lbs. of coal per actual horse power per hour ; but some engines reach a duty of above 100,000,000, or 1.74 lbs. of coal per actual horse power per hour. Locomotives consume from 8 to 10 lbs. of coke in evaporating a cubic foot of water, and the evaporation of a cubic foot of water per hour may be set down as representing an actual horse power in locomotives as well as in condensing engines, if expansion be not employed. When the locomotive is worked expansively, however, there is of course a less consumption of water and fuel per horse power, or per ton per mile, than when the full pressure is used throughout the stroke ; and most loco-

tives now operate with as much expansion as can be conveniently given by the slide valves.

230. *Q.*—But is not the evaporative power of locomotives affected materially by the proportions of the boiler?

A.—Yes, but this may be said of all boilers; but in locomotive boilers, perhaps, the effect of any misproportion becomes more speedily manifest. A high temperature of the fire box is found to be conducive to economy of fuel; and this condition, in its turn, involves a small area of grate bars. The heating surface of locomotive boilers should be about 80 square feet for each square foot of grate bars, and upon each foot of grate bars about 1 cwt. of coke should be burnt in the hour.

231. *Q.*—Probably the heat is more rapidly absorbed when the temperature of the furnace is high?

A.—That seems to be the explanation. The rapidity with which a hot body imparts heat to a colder, varies as the square of the difference of temperature; so that if the temperature of the furnace be very high, the larger part of the heat passes into the water at the furnace, thereby leaving little to be transmitted by the tubes. If, on the contrary, the temperature of the furnace be low, a large part of the heat will pass into the tubes, and more tube surface will be required to absorb it. About 16 cubic feet of water should be evaporated by a locomotive boiler for each square foot of fire grate, which, with the proportion of heating surface already mentioned, leaves 5 square feet of heating surface to evaporate a cubic foot of water in the hour. This is only about half the amount of sur-

face usual in land and marine boilers per cubic foot evaporated, and its small amount is due altogether to the high temperature of the furnace, which, by the rapidity of transmission it causes, is tantamount to an additional amount of heating surface.

232. *Q.*— You have stated that the steam and vacuum gauges are generally glass tubes, up which mercury is forced by the steam or sucked by the vacuum?

A.— Vacuum gauges are very often of this construction, but steam gauges more frequently consist of a small iron tube, bent like the letter U, and into which mercury is poured. The one end of this tube communicates with the boiler, and the other end with the atmosphere; and when the pressure of the steam rises in the boiler, the mercury is forced down in the leg communicating with the boiler, and rises in the other leg, and the difference of level in the legs denotes the pressure of the steam. In this gauge a rise of the mercury one inch in the one leg involves a difference of level between the two legs of two inches, and an inch of rise is, therefore, equivalent to two inches of mercury, or a pound of pressure. A small float of wood is placed in the open leg to show the rise or fall of the mercury, and this leg is surmounted by a brass scale, graduated in inches, to the marks of which the float points.

233. *Q.*— What other kinds of steam and vacuum gauges are there?

A.— There are many other kinds; but probably Bourdon's gauges are now in more extended use than any other, and their operation has been found to be

satisfactory in practice. The principle of their action may be explained to be, that a thin elliptical metal tube, if bent into a ring, will seek to coil or uncoil itself if subjected to external or internal pressure, and to an extent proportional to the pressure applied. The end of the tube is sharpened into an index, and moves to an extent corresponding to the pressure applied to the tube; but in the more recent forms of this apparatus, a dial and hand, like those of a clock, are employed, and the hand is moved round by a toothed sector connected to the tube, and which sector acts on a pinion attached to the hand. Mr. Shank, of Paisley, has lately introduced a form of steam gauge like a thermometer, with a flattened bulb; and the pressure of the steam, by compressing the bulb, causes the mercury to rise to a point proportional to the pressure applied.

THE INDICATOR.

234. Q.—You have already stated that the actual power of an engine is ascertained by an instrument called the indicator, which consists of a small cylinder with a piston moving against a spring, and compressing it to an extent answerable to the pressure of the steam. Will you explain further the structure and mode of using that instrument?

A.—The structure of the common form of indicator will be most readily apprehended by a reference to *fig. 29.*, which is a section of M'Naught's indicator. Upon a movable barrel *A*, a piece of paper is wound, the ends of which are secured by the slight brass

clamps shown in the drawing. The barrel is supported by the bracket *b*, proceeding from the body of

Fig. 29.

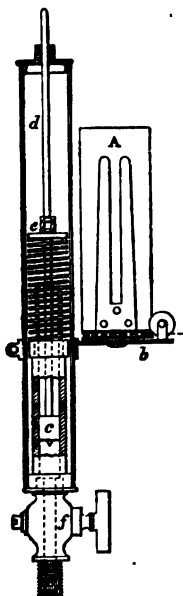

M'NAUGHT'S INDICATOR.

e a spiral spring of steel, which the piston, when forced upwards by the steam or sucked downwards by the vacuum, either compresses or extends; *f* is a cock attached to the cylinder of the indicator, and which is screwed into the cylinder cover. It is obvious that, so soon as this cock is opened, the

of the barrel a watch spring is coiled with one end attached to the barrel and the other end to the bracket, so that when the barrel is drawn round by a string wound upon its lower end like a roller blind, the spring returns the barrel to its original position when the string is relaxed. The string is attached to some suitable part of the engine, and at every stroke the string is drawn out, turning round the barrel, and the barrel is returned again by the spring on the return stroke.

235. Q.—But in what way can these reciprocations of the barrel determine the power of the engine?

A.—They do not determine it of themselves, but are only part of the operation. *c* is a small piston moving steam tight in a cylinder, *d* is the piston rod, and

piston *c* will be forced up when the space above the piston of the engine is opened to the boiler, and sucked down when that space is opened to the condenser—in each case to an extent proportionate to the pressure of the steam or the perfection of the vacuum, the top of the piston *c* being open to the atmosphere. A pencil, with a knife hinge, is inserted into the piston rod at *e*, and the point of the pencil bears upon the surface of the paper wound upon the drum *A*. If the drum *A* did not revolve, this pencil would merely trace on the paper a vertical line; but as the drum *A* moves round and back again every stroke of the engine, and as the pencil moves up and down again every stroke of the engine, the combined movements trace upon the paper a species of rectangle, which is called an indicator diagram; and the nature of this diagram determines the nature of the engine's performance.

236. *Q.*—How does it do this?

A.—It is clear that if the pencil was moved up instantaneously to the top of its stroke, and was also moved down instantaneously to the bottom of its stroke, and if it remained without fluctuation while at the top and bottom, the figure described by the pencil would be a perfect rectangle, of which the vertical height would represent the total pressure of the steam and vacuum, and therefore the total pressure urging the piston of the engine. But in practice the pencil will neither rise nor fall instantaneously, nor will it remain at a uniform height throughout the stroke. If the steam be worked expansively the pressure will begin to fall so soon as the steam is cut

off; and at the end of the stroke, when the steam comes to be discharged, the subsidence of pressure will not be instantaneous, but will occupy an appreciable time. It is clear, therefore, that in no engine can the diagram described by an indicator be a complete rectangle; but the more nearly it approaches to a rectangle the larger will be the power produced at every stroke with any given pressure, and the area of the space included within the diagram will in every case accurately represent the power exerted by the engine during that stroke.

237. Q.—And how is this area ascertained?

A.—It may be ascertained in various ways; but the usual mode is to take the vertical height of the diagram at a number of equidistant points on a base line, and then to take the mean of these several heights as representative of the mean pressure actually urging the piston. Now if you have the pressure on the piston per square inch, and if you know the number of square inches in its area, and the velocity with which it moves in feet per minute, you have obviously the dynamical effort of the engine, or, in other words, its actual power.

238. Q.—How is the base line you have referred to obtained?

A.—In proceeding to take an indicator diagram the first thing to be done is to allow the barrel to make two or three reciprocations with the pencil resting against it, before opening the cock attached to the cylinder. There will thus be traced a horizontal line, which is called the *atmospheric line*, and in condensing engines, a part of the diagram will be above

and a part of it below this line; whereas, in high pressure engines the whole of the diagram will be above this line. Upon this line the vertical ordinates may be set off at equal distances, or upon any base line parallel to it; but the usual course is to erect the ordinates on the atmospheric line.

239. Q.—Will you give an example of an indicator diagram?

A.—*Fig. 30.* is an indicator diagram taken from a

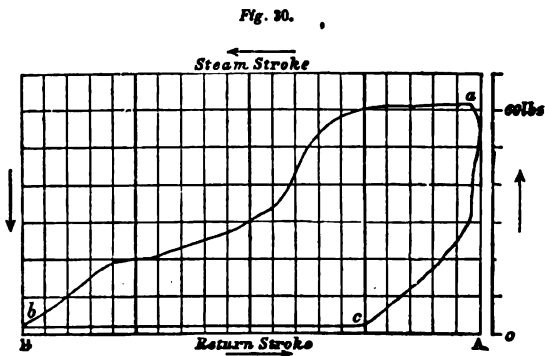

INDICATOR DIAGRAM.

high pressure engine, and the waving line *a, b, c*, forming a sort of irregular parallelogram, is that which is described by the pencil. As there is no vacuum in this engine the atmospheric line will be below the diagram, and it is represented by the line *A B*. The scale at the side shows the pressure of the steam, which in this engine rose to a little over 60 lbs. per square inch. The steam begins to be cut off

when about one-fourth of the stroke has been performed, and the pressure consequently falls. The rounding away of the right hand corner of the diagram, shows that the steam has been compressed on the reverse side of the piston by shutting the valve before the end of the stroke.

240. Q.—Is this species of indicator which you have just described applicable to locomotive engines?

A.—It is no doubt applicable under suitable conditions; but another species of indicator has been applied by Mr. Gooch to locomotive engines, which presents several features of superiority for such a purpose.

This indicator, which is represented in *fig. 31.*, has

Fig. 31.

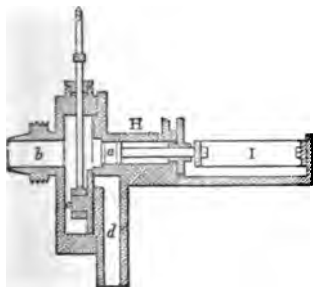

GOOCH'S INDICATOR FOR HIGH SPEEDS.

its cylinder H, placed horizontally; and its piston *a* compresses two elliptical springs I: *b* is the coupling which connects the indicator with the engine; *c* a slide valve, which is here substituted for a cock, to open or close the communication with the engine; and *d* is a passage to enable any condensed steam which may accumulate to be blown out. The top of the piston rod of this indicator is connected to the short arm of a smaller lever, to the longer arm of which the pencil is attached, and the pencil has thus a consider-

ably larger amount of motion than the piston ; but it moves in the arc of a circle instead of in a straight line. The pencil marks on a web of paper, which is unwound from one drum and wound on to another, so that a succession of diagrams are taken without the necessity of any intermediate manipulation.

241. Q.— These diagrams being taken with a pencil moving in an arc, will be of a distorted form ?

Fig. 32.

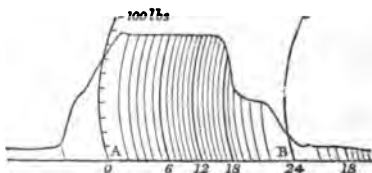

GOOCH'S DIAGRAM, as taken.

A.— They will not be of the usual form, but they may easily be translated into the usual form. Fig.

Fig. 33.

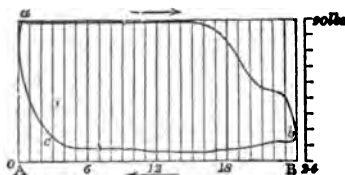

GOOCH'S DIAGRAM, as translated to the common form.

32. is one of Gooch's diagrams, as taken ; and *fig. 33.* is one of Gooch's diagrams, as translated by Mr

Clarke, and in which allowance is made for the various disturbing influences existing. To save the trouble of such reductions, however, it is undoubtedly preferable that the indicator should act immediately in the production of the final form of diagram.

DYNAMOMETER, GAUGES, AND CATARACT.

242. *Q.* — What other gauges or instruments are there for telling the state, or regulating the power of an engine?

A. — There is the counter for telling the number of strokes the engine makes, and the dynamometer for ascertaining the tractive power of steam vessels or locomotives; then there are the gauge cocks, and glass tubes, or floats, for telling the height of water in the boiler; and in pumping engines there is the cataract for regulating the speed of the engine.

243. *Q.* — Will you describe the mechanism of the counter?

A. — The counter consists of a train of wheel work, so contrived that by every stroke of the engine an index hand is moved forward a certain space, whereby the number of strokes made by the engine in any given time is accurately recorded. In most cases the motion is communicated by means of a detent, — attached to some reciprocating part of the engine, — to a ratchet wheel which gives motion to the other wheels in its slow revolution: but it is preferable to derive the motion from some revolving part of the engine by means of an endless screw, as where the ratchet is used the detent will sometimes fail to

carry it round the proper distance. In the counter contrived by Mr. Adie, an endless screw works into the rim of two small wheels situated on the same axis, but one wheel having a tooth more than the other, whereby a differential motion is obtained; and the difference in the velocity of the two wheels, or their motion upon one another, expresses the number of strokes performed. The endless screw is attached to some revolving part of the engine, whereby a rotatory motion is imparted to it; and the wheels into which the screws work hang down from it like a pendulum, and are kept stationary by the action of gravity.

244. Q.—What is the nature of the dynamometer?

A. — The dynamometer employed for ascertaining the traction upon railways consists of two flat springs joined together at the ends by links, and the amount of separation of the springs at the centre indicates, by means of a suitable hand and dial, the force of traction. A cylinder of oil, with a small hole through its piston, is sometimes added to this instrument to prevent sudden fluctuations. In screw vessels the forward thrust of the screw is measured by a dynamometer constructed on the principle of a weighing machine, in which a small spring pressure at the index will balance a very great pressure where the thrust is applied; and in each case the variations of pressure are recorded by a pencil on a sheet of paper, carried forward by suitable mechanism, whereby the mean thrust is easily ascertained. The tractive force of paddle wheel steamers is ascertained by a dynamometer fixed on shore, to which the floating vessel is attached by a rope. Sometimes the power of an

engine is ascertained by a friction break dynamometer applied to the shaft.

245. Q.— What will determine the amount of thrust shown by the dynamometer?

A.— In locomotives and in paddle steamers it will be determined by the force turning the wheels, and by the smallness of the diameter of the wheels; for with small wheels the thrust will be greater than with large wheels. In screw vessels the thrust will be determined by the force turning round the screw, and by the smallness of the screw's pitch; for with any given force of torsion a fine pitch of screw will give a greater thrust than a coarse pitch of screw, just as is the case when a screw works in a solid nut.

246. Q.— Will you explain the use of the glass gauges affixed to the boiler?

A.—The glass gauges are tubes affixed to the fronts of boilers, by the aid of which the height of the water within the boilers is readily ascertainable, for the water will stand at the same height in the tube as in the boiler, with which there is a communication maintained both at the top and bottom of the tube by suitable stopcocks. The cocks connecting the glass tube with the boiler should always be so constructed that the tube may be blown through with the steam, to clear it of any internal concretion that may impair its transparency; and the construction of the sockets in which the tube is inserted should be such, that, even when there is steam in the boiler, a broken tube may be replaced with facility.

247. Q.— What then are the gauge cocks?

A.— The gauge cocks are cocks penetrating the

boiler at different heights, and which, when opened, tell whether it is water or steam that exists at the level at which they are respectively inserted. It is unsafe to trust to the glass gauges altogether as a means of ascertaining the water level, as sometimes they become choked, and it is necessary, therefore, to have gauge cocks in addition; but if the boiler be short of steam, and a partial vacuum be produced within it, the glass gauges become of essential service, as the gauge cocks will not operate in such a case, for though opened, instead of steam and water escaping from them, the air will rush into the boiler. It is expedient to carry a pipe from the lower end of the glass tube downward into the water of the boiler, and a pipe from the upper end upward into the steam in the boiler, so as to prevent the water from boiling down through the tube, as it might otherwise do, and prevent the level of the water from being ascertainable. The average level of water in the boiler should be above the centre of the tube; and the lowest of the gauge cocks should always run water, and the highest should always blow steam.

248. Q. — Is not a float sometimes employed to indicate the level of the water in the boiler?

A. — A float for telling the height of water in the boiler is employed only in the case of land boilers, and its action is like that of a buoy floating on the surface, which, by means of a light rod passing vertically through the boiler, shows at what height the water stands. The float is usually formed of stone or iron, and is so counterbalanced as to make its operation the same as if it were a buoy of timber; and it

is generally put in connection with the feed valve, so that in proportion as the float rises, the supply of feed water is diminished. The feed water in land boilers is admitted from a small open cistern, situated at the top of an upright or stand pipe set upon the boiler, and in which there is a column of water sufficiently high to balance the pressure of the steam.

249. Q. — What is the cataract which is employed to regulate the speed of pumping engines?

A. — The cataract consists of a small pump-plunger and barrel, set in a cistern of water, the barrel being furnished on the one side with a valve opening inwards, through which the water obtains admission to the pump chamber from the cistern, and on the other by a cock, through which, if the plunger be forced down, the water must pass out of the pump chamber. The engine in the upward stroke of the piston, which is accomplished by the preponderance of weight at the pump end of the beam, raises up the plunger of the cataract by means of a small rod, — the water entering readily through the valve already referred to; and when the engine reaches the top of the stroke, it liberates the rod by which the plunger has been drawn up, and the plunger then descends by gravity, forcing out the water through the cock, the orifice of which has previously been adjusted, and the plunger in its descent opens the injection valve, which causes the engine to make a stroke.

250. Q. — Suppose the cock of the cataract be shut?

A. — If the cock of the cataract be shut, it is clear that the plunger cannot descend at all, and as in that case the injection valve cannot be opened, the engine

must stand still; but if the cock be slightly opened the plunger will descend slowly, the injection valve will slowly open, and the engine will make a gradual stroke as it obtains the water necessary for condensation. The extent to which the cock is open, therefore, will regulate the speed with which the engine works; so that, by the use of the cataract, the speed of the engine may be varied to suit the variations in the quantity of water requiring to be lifted from the mine. In some cases an air cylinder, and in other cases an oil cylinder, is employed instead of the apparatus just described; but the principle on which the whole of these contrivances operate is identical, and the only difference is in the detail.

251. Q. — You have now shown that the performance of an engine is determinable by the indicator; but how do you determine the power of the boiler?

A.—By the quantity of water it evaporates. There are now various forms of water-meter which accurately determine the quantity of water flowing through them; so that the volume of the feed water, and also of the condensing water, may now be readily ascertained.

CHAP. V.

PROPORTIONS OF BOILERS.

HEATING AND FIRE GRATE SURFACE.

252. Q.—What are the considerations which must chiefly be attended to in settling the proportions of boilers?

A.—In the first place there must be sufficient grate surface to enable the quantity of coal requisite for the production of the steam to be conveniently burnt, taking into account the intensity of the draught; and in the next place there must be a sufficient flue surface readily to absorb the heat thus produced, so that there may be no needless waste of heat by the chimney. The flues, moreover, must have such an area, and the chimney must be of such dimensions, as will enable a suitable draught through the fire to be maintained; and finally the boiler must be made capable of containing such supplies of water and steam as will obviate inconvenient fluctuations in the water level, and abate the risk of water being carried over into the engine with the steam. With all these conditions the boiler must be as light and compact as possible, and must be so contrived as to be capable of being cleaned and repaired with facility. Finally it must be strong.

253. Q. — Supposing, then, that you had to proportion a boiler, which should be capable of supplying steam sufficient to propel a steam vessel or railway train at a given speed, or to perform any other given work, how would you proceed?

A. — I would first ascertain the resistance which had to be overcome, and the velocity with which it was necessary to overcome it. I should then be in a position to know what pressure and volume of steam were required to overcome the resistance at the prescribed rate of motion; and, finally, I should allow a sufficient heating and fire grate surface in the boiler according to the kind of boiler it was, to furnish the requisite quantity of steam, or, in other words, to evaporate the requisite quantity of water.

254. Q. — Will you state the amount of heating surface and grate surface necessary to evaporate a given quantity of water?

A. — The number of square feet of heating or flue surface, required to evaporate a cubic foot of water per hour, is about 70 square feet in Cornish boilers, 8 to 11 square feet in land and marine boilers, and 5 or 6 square feet in locomotive boilers. The number of square feet of heating surface per square foot of fire grate, is from 13 to 15 square feet in waggon boilers; about 40 square feet in Cornish boilers; and from 50 to 90 square feet in locomotive boilers. About 80 square feet in locomotives is a very good proportion.

255. Q. — What is the heating surface of boilers per horse power?

A. — About 9 square feet of flue and furnace surface per horse power is the usual proportion in waggon

boilers, reckoning the total surface as effective surface, if the boilers be of a considerable size; but in the case of small boilers the proportion is larger. The total heating surface of a two horse power waggon boiler is, according to Boulton and Watt's proportions, 30 square feet, or 15 ft. per horse power; whereas, in the case of a 45 horse power boiler the total heating surface is 438 square feet, or 9.6 ft. per horse power. In marine boilers nearly the same proportions obtain. The original boilers of the Great Western steamer, by Messrs. Maudslay, were proportioned with about 10 square feet of flue and furnace surface per horse power, reckoning the total amount as effective; but in the boilers of the Retribution, by the same makers, but of larger size, a somewhat smaller proportion of heating surface was adopted. Boulton and Watt have found that in their marine flue boilers, 9 square feet of flue and furnace surface are requisite to boil off a cubic foot of water per hour, which is the proportion of heating surface that is allowed in their land boilers per horse power; but inasmuch as in most modern engines, and especially in marine engines, the nominal very much exceeds the actual power, they allow very much more heating surface than this per nominal horse power in their marine boilers, and they reckon as effective heating surface the tops of the flues, and the whole of the sides of the flues, but not the bottoms. For their land engines they still retain Mr. Watt's standard of power, which makes the actual and the nominal power identical; and an actual horse power is the equivalent of a cubic foot of water raised into steam every hour.

256. Q.—What is the proper proportion of fire grate per horse power?

A.—Boulton and Watt allow 0.64 of a square foot area of grate bars per nominal horse power in their marine boilers, and a good effect arises from this proportion; but sometimes so large an area of fire grate cannot be conveniently got, and the proportion of half a square foot per horse power, which is the proportion adopted in the original boiler of the Great Western, seems to answer very well in engines working with a moderate pressure, and with some expansion; and this proportion is now very widely adopted.* With this allowance, there will be 22 to 24 square feet of heating surface per square foot of fire grate; and if the consumption of fuel be taken at 6 lbs. per nominal horse power per hour, there will be about 12 lbs. of coal consumed per hour on each square foot of grate. The furnaces should not be more than 6 ft. long, as, if much longer than this, it will be impossible to work them properly for any considerable length of time, as they will become choked with clinker at the back ends.

257. Q.—What quantity of fuel is usually consumed per hour, on each square foot of fire grate?

A.—The quantity of fuel burned on each square foot of fire grate per hour, varies very much in different boilers: in waggon boilers it is from 10 to 13 lbs.; in Cornish boilers from $3\frac{1}{2}$ to 4 lbs.; and in locomotive boilers from 80 to 150 lbs.; but about 1 cwt. per hour is a good proportion in locomotives, as has been already explained.

* These proportions of marine boilers are now antiquated. The modern proportions will be found in the Introduction.

CALORIMETER AND VENT.

258. Q.—In what manner are the proper sectional area and the proper capacity of the flue of a boiler determined?

A.—The proper collective area for the escape of the smoke and flame over the furnace bridges in marine boilers is 19 square inches per nominal horse power, according to Boulton and Watt's practice, and for the sectional area of the flue they allow 18 square inches per horse power. The sectional area of the flue in square inches is what is termed the *calorimeter* of the boiler, and the calorimeter divided by the length of the flue in feet is what is termed the *vent*. In marine flue boilers of good construction the vent varies between the limits of 20 and 25, according to the size of the boiler and other circumstances—the largest boilers having generally the largest vents; and the calorimeter divided by the vent will give the length of the flue in feet. The flues of all flue boilers diminish in their calorimeter as they approach the chimney, as the smoke contracts in its volume in proportion as it parts with its heat.

259. Q.—Is the method of determining the dimensions of a boiler flue, by a reference to its vent and calorimeter, the method generally pursued?

A.—It is Boulton and Watt's method; but some very satisfactory boilers have been made by allowing a proportion of 0.6 of a square foot of fire grate per nominal horse power, and making the sectional area of the flue at the largest part $\frac{1}{4}$ th of the area of fire

grate, and at the smallest part, where it enters the chimney, $\frac{1}{11}$ th of the area of the fire grate. These proportions are retained whether the boiler is flue or tubular, and from 14 to 16 square feet of tube surface is allowed per nominal horse power.

260. Q.— Are the proportions of vent and calorimeter, taken by Boulton and Watt for marine flue boilers, applicable also to waggon and tubular boilers?

A.— No. In waggon and tubular boilers very different proportions prevail, yet the proportions of every kind of boiler are determinable on the same general principle. In waggon boilers the proportion of the perimeter of the flue which is effective as heating surface, is to the total perimeter as 1 to 3, or, in some cases as 1 to 2.5; and with any given area of flue, therefore, the length of the flue must be from 3 to 2.5 times greater than would be necessary if the total surface were effective, else the requisite quantity of heating surface will not be obtained. If then the vent be the calorimeter divided by the length, and the length be made 3 or 2.5 times greater, the vent must become 3 or 2.5 times less; and in waggon boilers accordingly the vent varies from 8 to 11 instead of from 21 to 25, as in the case of marine flue boilers. In tubular marine boilers the calorimeter is usually made only about half the amount allowed by Boulton and Watt for marine flue boilers, or, in other words, the collective sectional area of the tubes, for the transmission of the smoke, is from 8 to 9 square inches per nominal horse power. It is better, however, to make the sectional area larger than this, and to work the boiler with the damper sufficiently closed to prevent

the smoke and flame from rushing exclusively through a few of the tubes.

261. Q. — What are the ordinary dimensions of the flue in waggon boilers ?

A. — In Boulton and Watt's 45 horse waggon boiler the area of flue is 18 square inches per horse power, but the area per horse power increases very rapidly as the size of the boiler becomes less, and amounts to about 80 square inches per horse power in a boiler of 2 horse power. Some such increase is obviously inevitable, if a similar form of flue be retained in the larger and smaller powers, and at the same time the elongation of the flue in the same proportion as the increase of any other dimension is prevented; but in the smaller class of waggon boilers the consideration of facility of cleaning the flues is also operative in inducing a large proportion of sectional area. Boulton and Watt's 2 horse power waggon boiler has 30 square feet of surface, and the flue is 18 inches high above the level of the boiler bottom, by 9 inches wide; while their 12 horse waggon boiler has 118 square feet of heating surface, and the dimensions of the flue similarly measured are 36 inches by 13 inches. The width of the smaller flue, if similarly proportioned to the larger one, would be $6\frac{1}{2}$ inches, instead of 9 inches, and, by assuming this dimension, we should have the same proportion of sectional area per square foot of heating surface in both boilers. The length of flue in the 2 horse boiler is 19.5 ft., and in the 12 horse boiler 39 ft., so that the length and height of the flue are increased in the same proportion.

262. Q. — Will you give an example of the proportions of a flue, in the case of a marine boiler?

A. — The Nile steamer, with engines of 110 horse power by Boulton and Watt, is supplied with steam by two boilers, which are, therefore, of 55 horse power each. The height of the flue winding within the boiler is 60 inches, and its mean width $16\frac{1}{2}$ inches, making a sectional area or calorimeter of 990 square inches, or 18 square inches per horse power of the boiler. The length of the flue is 39 ft., making the vent 25, which is the vent proper for large boilers. In the Dee and Solway steamers, by Scott and Sinclair, the calorimeter is only 9.72 square inches per horse power; in the Eagle, by Caird, 11.9; in the Thames and Medway, by Maudslay, 11.34, and in a great number of other cases it does not rise above 12 square inches per horse power; but the engines of most of these vessels are intended to operate to a certain extent expansively, and the boilers are less powerful in evaporating efficacy on that account.

263. Q. — Then the chief difference in the proportions established by Boulton and Watt, and those followed by the other manufacturers you have mentioned is, that Boulton and Watt set a more powerful boiler to do the same work?

A. — That is the main difference. The proportion which one part of the boiler bears to another part is very similar in the cases cited, but the proportion of boiler relatively to the size of the engine varies very materially. Thus the calorimeter of *each boiler* of the Dee and Solway is 1296 square inches; of the Eagle, 1548 square inches; and of the Thames and Medway.

1134 square inches; and the length of flue is 57, 60, and 52 ft. in the boilers respectively, which makes the respective vents $22\frac{1}{2}$, 25, and 21. Taking then the boiler of the Eagle for comparison with the boiler of the Nile, as it has the same vent, it will be seen that the proportions of the two are almost identical, for 990 is to 1548 as 39 is to 60, nearly; but Messrs. Boulton and Watt would not have set a boiler like that of the Eagle to do so much work.

264. Q.—Then the evaporating power of the boiler varies as the sectional area of the flue?

A.—The evaporating power varies as the square root of the area of the flue, if the length of the flue remain the same; but it varies as the area simply, if the length of the flue be increased in the same proportion as its other dimensions. The evaporating power of a boiler is referable to the amount of its heating surface, and the amount of heating surface in any flue or tube is proportional to the product of the length of the tube and the square root of its sectional area, multiplied by a certain quantity that is constant for each particular form. But in similar tubes the length is proportional to the square root of the sectional area; therefore, in similar tubes, the amount of heating surface is proportional to the sectional area. On this area also depends the quantity of hot air passing through the flue, supposing the intensity of the draught to remain unaffected, and the quantity of hot air or smoke passing through the flue should vary in the same ratio as the quantity of surface.

265. Q.—A boiler therefore, to exert four times the power, should have four times the extent of heating

surface, and four times the sectional area of flue for the transmission of the smoke ?

A. — Yes ; and if the same form of flue is to be retained it should be of twice the diameter and twice the length ; or twice the height and width if rectangular, and twice the length. As then the diameter or square root of the area increases in the same ratio as the length, the square root of the area divided by the length ought to be a constant quantity in each type of boiler, in order that the same proportions of flue may be retained ; and in waggon boilers without an internal flue the height in inches of the flue encircling the boiler divided by the length of the flue in feet will be 1 very nearly. Instead of the square root of the area the effective perimeter, or outline of that part of the cross section of the flue which is effective in generating steam, may be taken ; and the effective perimeter divided by the length ought to be a constant quantity in similar forms of flue and with the same velocity of draught, whatever the size of the flue may be.

266. *Q.* — Will this proportion alter if the form of the flue be changed ?

A. — It is clear, that with any given area of flue, to increase the perimeter by adopting a different shape is tantamount to a diminution of the length of the flue ; and, if the perimeter be diminished the length of the flue must at the same time be increased, else it will be impossible to obtain the necessary amount of heating surface. In Boulton and Watt's waggon boilers the sectional area of the flue in square inches per square foot of heating surface is 5·4 in the two

horse boiler; in the three horse it is 4.74; in the four horse, 4.35; six horse, 3.75; eight horse, 4.33; ten horse, 3.96; twelve horse, 3.63; eighteen horse, 3.17; thirty horse, 2.52; and in the forty-five horse boiler, 2.05 square inches. Taking the amount of heating surface in the 45 horse boiler at 9 square feet per horse power, we obtain 18 square inches of sectional area of flue per horse power, which is also Boulton and Watt's proportion of sectional area for marine boilers with internal flues.

267. Q. — If to increase the perimeter of a flue is virtually to diminish the length, then a tubular boiler where the perimeter is in effect greatly extended ought to have but a short length of tube?

A. — The flue of the Nile steamer if reduced to the cylindrical form would be $35\frac{1}{2}$ inches in diameter to have the same area; but it would then require to be made $47\frac{3}{4}$ feet long, to have the same amount of heating surface excluding the bottom as non-effective. Supposing that with these proportions the heat is sufficiently extracted from the smoke, then every tube of a tubular boiler in which the same draught existed ought to have very nearly the same proportions.

268. Q. — But what are the best proportions of the parts of tubular boilers relatively with one another?

A. — The proper relative proportions of the parts of tubular boilers may easily be ascertained by a reference to the settled proportions of flue boilers; for the same general principles are operative in both cases. In the Nile steamer each boiler of 55 horse power has about 497 square feet of flue surface or 9 square feet per horse power reckoning the total surface

as effective. The area of the flue which is rectangular is 990 square inches, therefore the area is equal to that of a tube $35\frac{1}{2}$ inches in diameter; and such a tube to have a heating surface of 497 square feet must be 53.4 feet or 640.8 inches in length. The length, therefore, of the tube will be about 18 times its diameter, and with the same velocity of draught these proportions must obtain, whatever the absolute dimensions of the tube may be. With a calorimeter therefore of 18 square inches per horse power the length of a tube 3 inches diameter must not exceed 4 feet 6 inches, since the heat will be sufficiently extracted from the smoke in this length, if the smoke only travels at the velocity due to a calorimeter of 18 square inches per horse power.

269. Q.— Is this then the maximum length of flue which can be used in tubular boilers with advantage ?

A.— By no means. The tubes of tubular boilers are almost always more than 4 feet 6 inches long, but then the calorimeter is almost always less than 18 square inches per horse power — generally about two-thirds of this. Indeed, tubular boilers with a large calorimeter are not found to be so satisfactory as where the calorimeter is small, partly from the propensity of the smoke in such cases to pass through a few of the tubes instead of the whole of them, and partly from the deposit of soot which takes place when the draught is sluggish. It is a very confusing practice, however, to speak of nominal horse power in connection with boilers, since that is a quantity quite indeterminate.

EVAPORATIVE POWER OF BOILERS.

270. *Q.*—The main thing after all in boilers is their evaporative powers?

A.—The proportions of tubular boilers as of all boilers should obviously have reference to the evaporation required, whereas the demand upon the boiler for steam is very often reckoned contingent upon the nominal horse power of the engine; and as the nominal power of an engine is a conventional quantity by no means in uniform proportion to the actual quantity of steam consumed, perplexing complications as to the proper proportions of boilers have in consequence sprung up, to which most of the failures in that department of engineering may be imputed. It is highly expedient therefore in planning boilers for any particular engine to consider exclusively the actual power required to be produced, and to apportion the capabilities of the boiler accordingly.

271. *Q.*—In other words, you would recommend the inquiry to be restricted to the mode of evaporating a given number of cubic feet of water in the hour, instead of embracing the problem how an engine of a given nominal power was to be supplied with steam?

A.—I would first, as I have already stated, consider the actual power required to be produced, and then fix the amount of expansion to be adopted. If the engine had to work up to three times its nominal power, as is now common in marine engines, I should either increase correspondingly the quantity of evaporating surface in the boiler, or adopt such an amount

of expansion as would increase threefold the efficacy of the steam, or combine in a modified manner both of these arrangements. Reckoning the evaporation of a cubic foot of water in the hour as equivalent to an actual horse power, and allowing a square yard or 9 square feet as the proper proportion of flue surface to evaporate a cubic foot of water in the hour, it is clear that I must either give 27 square feet of heating surface in the boiler to have a trebled power without expansion, or I must cut off the steam at one-seventh of the stroke to obtain a threefold power without increasing the quantity of heating surface. By cutting off the steam however at one-third of the stroke, a heating surface of $13\frac{1}{2}$ square feet will give a threefold power, and it will usually be the most judicious course to carry the expansion as far as possible, and then to add the proportion of heating surface necessary to make good the deficiency still found to exist.

272. Q. — But is it certain that a cubic foot of water evaporated in the hour is equivalent to an actual horse power?

A. — An actual horse power as fixed by Watt is 33,000 lbs. raised one foot high in the minute; and in Watt's 40 horse power engine with a $31\frac{1}{2}$ inch cylinder 7 feet stroke, and making $17\frac{1}{2}$ strokes a minute, the effective pressure is 6.92 lbs. on the square inch clear of all deductions. Now, as a horse power is 33,000 lbs. raised one foot high, and as there are 6.92 lbs. on the square inch, it is clear that 33,000 divided by 6.92, or 4768 square inches with 6.92 lbs. on each if lifted 1 foot or 12 inches high, will also be equal to a horse power. But 4768 square inches multiplied by 12

inches in height is 57224·4 cubic inches, or 33·1 cubic feet, and this is the quantity of steam which must be expended per minute to produce an actual horse power.

273. Q. — But are 33 cubic feet of steam expended per minute equivalent to a cubic foot of water expended in the hour?

A. — Not precisely, but nearly so. A cubic foot of water produces 1669 cubic feet of steam of the atmospheric density of 15 lbs. per square inch, whereas a consumption of 33 cubic feet of steam in the minute is 1980 cubic feet in the hour. In Watt's engines about one-tenth was reckoned as loss in filling the waste spaces at the top and bottom of the cylinder, making 1872 cubic feet as the quantity consumed per hour without this waste; and in modern engines the waste at the ends of the cylinder is inconsiderable.

274. Q. — What power was generated by a cubic foot of water in the case of the Albion Mill engines when working without expansion?

A. — In the Albion Mill engines when working without expansion, it was found that 1 lb. of water in the shape of steam raised 28,489 lbs. 1 foot high. A cubic foot of water, therefore, or 62½ lbs., if consumed in the hour, would raise 1780562·5 lbs. one foot high in the hour, or would raise 29,676 lbs. one foot high in a minute; and if to this we add one-tenth for waste at the ends of the cylinder, a waste which hardly exists in modern engines, we have 32,643 lbs. raised one foot high in the minute, or a horse power very nearly. In some cases the approximation appears still nearer. Thus, in a 40 horse engine working

without expansion, Watt found that $\cdot 674$ feet of water were evaporated from the boiler per minute, which is just a cubic foot per horse power per hour ; but it is not certain in this case that the nominal and actual power were precisely identical. It will be quite safe, however, to reckon an actual horse power as producible by the evaporation of a cubic foot of water in the hour in the case of engines working without expansion ; and for boiling off this quantity in flue or waggon boilers, about 8 lbs. of coal will be required and 9 square feet of flue surface.

MODERN MARINE AND LOCOMOTIVE BOILERS.

275. Q.—These proportions appear chiefly to refer to old boilers. I wish you to state what are the proportions of modern flue and tubular marine boilers.

A.—In modern marine boilers the area of fire grate is less than in Mr. Watt's original boilers, where it was one square foot to nine square feet of heating surface. The heat in the furnace is consequently more intense, and a somewhat less amount of surface suffices to evaporate a cubic foot of water. In Boulton and Watt's modern flue boilers they allow for the evaporation of a cubic foot of water 8 square feet of heating surface, 70 square inches of fire grate, 13 square inches sectional area of flues, 6 square inches sectional area of chimney, 14 square inches area over furnace bridges, ratio of area of flue to area of fire grate 1 to 5·4. To evaporate a cubic foot of water per hour in tubular boilers, the proportions are— heating surface 9 square feet, fire grate 70 square

inches, sectional area of tubes 10 square inches, sectional area of back uptake 12 square inches, sectional area of front uptake 10 square inches, sectional area of chimney 7 square inches, ratio of diameter of tube to length of tube $\frac{1}{8}$ th to $\frac{1}{10}$ th, cubical content of boiler exclusive of steam chest 6.5 cubic feet, cubical content of steam chest 1.5 cubic feet.

276. Q. — These proportions do not apply to locomotive boilers?

A. — Not at all. In locomotive boilers the draught

	Name of Engine.			
	Great Britain.	Pallas.	Seabe.	Sphinx.
Diameter of cylinder -	18 in.	15 in.	14½ in.	18 in.
Length of stroke -	24 in.	20 in.	21 in.	24 in.
Diameter of driving wheel -	8 ft.	6 ft.	6½ ft.	5 ft.
Inside length of fire box -	53 in.	55 in.	41½ in.	44 in.
Inside width of fire box -	63 in.	42 in.	42½ in.	39½ in.
Height of fire box above bars -	63 in.	52 in.	48½ in.	55½ in.
Number of fire bars -	29	-	32	16
Thickness of fire bars -	¾ in.	1½ in.	¾ in.	1 in.
Number of tubes -	306	134	181	142
Outside diameter of tubes -	2 in.	2 in.	1½ in.	2½ in.
Length of tubes -	11 ft. 3 in.	10 ft. 6 in.	10 ft. 2½ in.	14 ft. 3½ in.
Space between tubes -	½ in.	¾ in.	½ in.	-
Inside diameter of ferules -	1½ in.	1½ in.	1½ in.	1½ in.
Diameter of chimney -	17 in.	15 in.	13 in.	15½ in.
Diameter of blast orifice -	5½ in.	4½ in.	4½ in.	4½ in.
Area of fire grate -	21 sq. ft.	16.04 sq. ft.	12.4 sq. ft.	10.56 sq. ft.
Area of air space of grate -	11.4 sq. ft.	4.08 sq. ft.	5.54 sq. ft.	5 sq. ft.
Area of tubes -	5.46 sq. ft.	2.40 sq. ft.	2.8 sq. ft.	2.92 sq. ft.
Area through ferules -	4 sq. ft.	1.64 sq. ft.	2 sq. ft.	2.04 sq. ft.
Area of chimney -	1.77 sq. ft.	1.23 sq. ft.	.921 sq. ft.	1.31 sq. ft.
Area of blast orifice -	23.76 sq. in.	16.8 sq. in.	14.18 sq. in.	17.7 sq. in.
Heating surface of tubes -	1627 sq. ft.	668.7 sq. ft.	823 sq. ft.	864.8 sq. ft.

is maintained by the projection of the waste steam which escapes from the cylinders up the chimney, and the draught is much more powerful and the combustion much more rapid than in cases in which the combustion is maintained by the natural draught of a chimney, except indeed the chimney be of very unusual temperature and height. The proportions proper for locomotive boilers will be seen by the dimensions of a few locomotives of approved construction, which have been found to give satisfactory results in practice, and which are recorded in the Table on the preceding page.

THE BLAST IN LOCOMOTIVES.

277. *Q.*— What is the amount of draught produced in locomotive boilers in comparison with that existing in other boilers?

A.— A good chimney of a land engine will produce a degree of exhaustion equal to from $1\frac{1}{2}$ to $2\frac{1}{2}$ inches of water. In locomotive boilers the exhaustion is in some cases equal to 12 or 13 inches of water, but from 3 to 6 inches is a more common proportion.

278. *Q.*— And what force of blast is necessary to produce this exhaustion?

A.— The amount varies in different engines, depending on the sectional area of the tubes and other circumstances. But on the average, it may be asserted that such a pressure of blast as will support an inch of mercury, will maintain sufficient exhaustion in the smoke box to support an inch of water; and this ratio holds whether the exhaustion is little or great. To produce an exhaustion in the smoke box, therefore, of

6 inches of water, the waste steam would require to be of sufficient pressure to support a column of 6 inches of mercury, which is equivalent to a pressure of 8 lbs. on the square inch.

279. Q. — How is the force of the blast determined?

A. — By the amount of contraction given to the mouth of the blast pipe, which is a pipe which conducts the waste steam from the cylinders and debouches at the foot of the chimney. If a strong blast be required, the mouth of this pipe requires to be correspondingly contracted, but such contraction throws a back pressure on the piston, and it is desirable to obtain the necessary draught with as little contraction of the blast pipe as possible. The blast pipe is generally a breeches pipe of which the legs join just before reaching the chimney; but it is better to join the two cylinders below, and to let a single pipe ascend to within 12 or 18 inches of the foot of the chimney. If made with too short a piece of pipe above the joining, the steam will be projected against each side of the chimney alternately, and the draught will be damaged and the chimney worn. The blast pipe should not be regularly tapered, but should be large in the body and gathered in at the mouth.

280. Q. — Is a large and high chimney conducive to strength of draught in locomotives?

A. — It has not been found to be so. A chimney of three or four times its own diameter in height appears to answer fully as well as a longer one; and it was found that when in an engine with 17 inch cylinders a chimney of $15\frac{1}{2}$ inches was substituted for a

chimney of $17\frac{1}{2}$ inches, a superior performance was the result. The chimney of a locomotive should have half the area of the tubes at the ferules which is the most contracted part, and the blast orifice should have $\frac{1}{10}$ th of the area of the chimney. The sectional area of the tubes through the ferules should be as large as possible. Tubes without ferules it is found pass one-fourth more air and tubes with ferules only at the smoke box end pass one-tenth more air than when there are ferules at both ends.

281. Q. — Is the exhaustion produced by the blast as great in the fire box as in the smoke box ?

A. — Experiments have been made to determine this, and in few cases has it been found to be more than about half as great at ordinary speeds ; but much depends on the amount of contraction in the tubes. In an experiment made with an engine having 147 tubes of $1\frac{3}{4}$ inches external diameter and 13 feet 10 inches long, and with a fire grate having an area of $9\frac{1}{2}$ square feet, the exhaustion at all speeds was found to be three times greater in the smoke box than in the fire box. The exhaustion in the smoke box was generally equivalent to 12 inches of water, while in the fire box it was equivalent to only 4 inches of water ; showing that 4 inches were required to draw the air through the grate and 8 inches through the tubes.

282. Q. — What will be the increase of evaporation in a locomotive from a given increase of exhausticn ?

A. — The rate of evaporation in a locomotive or any other boiler will vary as the quantity of air passing through the fire, and the quantity of air passing

through the fire will vary nearly as the square root of the exhaustion. With four times the exhaustion therefore there will be about twice the evaporation, and experiment shows that this theoretical law holds with tolerable accuracy in practice.

283. *Q.* — But the same exhaustion will not be produced by a given strength of blast in all engines?

A. — No; engines with contracted fire grates and an inadequate sectional area of tubes, will require a stronger blast than engines of better proportions; but in any given engine the relations between the blast exhaustion and evaporation hold which have been already defined.

284. *Q.* — Is the intensity of the draught under easy regulation?

A. — The intensity of the draught may easily be diminished by partially closing the damper in the chimney, and it may be increased by contracting the orifice of the blast. A variable blast pipe, the orifice of which may be enlarged or contracted at pleasure, has been much used. There are various devices for this purpose, but the best appears to be that adopted in Stephenson's engine, where a conical nozzle is moved up or down within the blast pipe, which is made somewhat larger in diameter than the base of the cone, but with a ring projecting internally, against which the base of the cone abuts when the nozzle is pushed up. When the nozzle stands at the top of the pipe the whole of the steam has to pass through it, and the intensity of the blast is increased by the increased velocity thus given to the steam; whereas when the nozzle is moved downward the steam escapes

through the annular opening left between the nozzle and the pipe, as well as through the nozzle itself, and the intensity of the blast is diminished by the enlargement of the opening for the escape of the steam thus made available.

285. *Q.* — What is the best diameter for the tubes of locomotive boilers ?

A.—Bury's locomotive with 14 inch cylinders contains 92 tubes of $2\frac{1}{8}$ th inches external diameter, and 10 feet 6 inches long ; whereas Stephenson's locomotive with 15 inch cylinders contains 150 tubes of $1\frac{5}{8}$ ths external diameter, 13 feet 6 inches long. In Stephenson's boiler, in order that the part of the tubes next the chimney may be of any avail for the generation of steam, the draught has to be very intense, which in its turn involves a considerable expenditure of power ; and it is questionable whether the increased expenditure of power upon the blast, in Stephenson's long tubed locomotives, is compensated by the increased generation of steam consequent upon the extension of the heating surface. When the tubes are small in diameter they are apt to become partially choked with pieces of coke ; but an internal diameter of $1\frac{5}{8}$ ths may be employed without inconvenience if the draught be of medium intensity.

286. *Q.* — Will you illustrate the relation between the length and diameter of locomotive tubes by a comparison with the proportion of flues in flue boilers ?

A.—In most locomotives the velocity of the draught is such that it would require very long tubes to extract the heat from the products of combustion, if the heat

were transmitted through the metal of the tubes with only the same facility as through the iron of ordinary flue boilers. The Nile steamer, with engines of 110 nominal horses power each, and with two boilers having two independent flues in each, of such dimensions as to make each flue equivalent to 55 nominal horses power, works at 62 per cent. above the nominal power, so that the actual evaporative efficacy of each flue would be equivalent to 89 actual horses power, supposing the engines to operate without expansion; but as the mean pressure in the cylinder is somewhat less than the initial pressure, the evaporative efficacy of each flue may be reckoned equivalent to 80 actual horses power. With this evaporative power there is a calorimeter of 990 square inches, or 12·8 square inches per actual horse power; whereas in Stephenson's locomotive with 150 tubes, if the evaporative power be taken at 200 cubic feet of water in the hour, which is a large supposition, the engine will be equal to 200 actual horses power. If the internal diameter of the tubes be taken at thirteen-eighths of an inch, the calorimeter per actual horse power will only be 1·1136 square inches, or in other words the calorimeter in the locomotive boiler will be 11·11 times less than in the flue boiler for the same power, so that the draught in the locomotive must be 11·11 times stronger, and the ratio of the length of the tube to its diameter 11·11 times greater than in the flue boiler, supposing the heat to be transmitted with only the same facility. The flue of the Nile would require to be $35\frac{1}{2}$ inches in diameter if made of the cylindrical form, and $47\frac{3}{4}$ feet long: the tubes of a locomotive if $1\frac{3}{8}$ ths inch diameter

would only require to be 22·19 inches long with the same velocity of draught; but as the draught is 11·11 times faster than in a flue boiler, the tubes ought to be 246·558 inches, or about 20½ feet long according to this proportion. In practice, however, they are one-third less than this, which reduces the heating surface from 9 to 6 square feet per actual horse power, and this length even is found to be inconvenient. It is greatly preferable therefore to increase the calorimeter, and diminish the intensity of the draught.

BOILER CHIMNIES.

287. *Q.* — By what process do you ascertain the dimensions of the chimney of a land boiler?

A.—By a reference to the volume of air it is necessary in a given time to supply to the burning fuel, and to the velocity of motion produced by the rarefaction in the chimney; for the area of the chimney requires to be such, that with the velocity due to that rarefaction, the quantity of air requisite for the combustion of the fuel shall pass through the furnace in the specified time. Thus if 200 cubic feet of air of the atmospheric density are required for the combustion of a pound of coal,—though 250 lbs. is nearer the quantity generally required,—and 10 lbs. of coal per horse power per hour are consumed by an engine, then 2000 cubic feet of air must be supplied to the furnace per horse power per hour, and the area of the chimney must be such as to deliver this quantity at the increased bulk due to the high temperature of the chimney when moving with the velocity the rarefaction

within the chimney occasions, and which, in small chimneys, is usually such as to support a column of half an inch of water. The velocity with which a denser fluid flows into a rarer one is equal to the velocity a heavy body acquires in falling through a height equal to the difference of altitude of two columns of the heavier fluid of such heights as will produce the respective pressures; and, therefore, when the difference of pressure or amount of rarefaction in the chimney is known, it is easy to tell the velocity of motion which ought to be produced by it. In practice, however, these theoretical results are not to be trusted, until they have received such modifications as will make them representative of the practice of the most experienced constructors.

288. Q.—What then is the rule followed by the most experienced constructors?

A.—Boulton and Watt's rule for the dimensions of the chimney of a land engine is as follows:—multiply the number of pounds of coal consumed under the boiler per hour by 12, and divide the product by the square root of the height of the chimney in feet; the quotient is the area of the chimney in square inches in the smallest part. A factory chimney suitable for a 20 horse boiler is commonly made about 20 in. square inside, and 80 ft. high; and these dimensions are those which answer to a consumption of 15 lbs. of coal per horse power per hour, which is a very common consumption in factory engines. If 15 lbs. of coal be consumed per horse power per hour, the total consumption per hour in a 20 horse boiler will be 300 lbs., and 300 multiplied by 12=3600, and divided by 9

(the square root of the height) = 400, which is the area of the chimney in square inches. It will not answer well to increase the height of a chimney of this area to more than 40 or 50 yards, without also increasing the area, nor will it be of utility to increase the area much without also increasing the height. The quantity of coal consumed per hour in pounds, multiplied by 5, and divided by the square root of the height of the chimney, is the proper collective area of the openings between the bars of the grate for the admission of air to the fire.

259. Q.—Is this rule applicable to the chimnies of steam vessels?

A.—In steam vessels Boulton and Watt have heretofore been in the habit of allowing $8\frac{1}{2}$ square inches of area of chimney per horse power, but they now allow 6 square inches to 7 square inches. In some steam vessels a steam blast like that of a locomotive, but of a smaller volume, is used in the chimney, and many of the evils of a boiler deficient in draught may be remedied by this expedient, but a steam blast in a low pressure engine occasions an obvious waste of steam; it also makes an unpleasant noise, and in steam vessels it frequently produces the inconvenience of carrying the smaller parts of the coal up the chimney, and scattering it over the deck among the passengers. It is advisable, therefore, to give a sufficient calorimeter in all low pressure boilers, and a sufficient height of chimney to enable the chimney to operate without a steam jet; but it is useful to know that a steam jet is a resource in the case of a defective boiler, or where the boiler has to be urged beyond its power.

STEAM ROOM AND PRIMING.

290. *Q.*—What is the capacity of steam room allowed in boilers per horse power?

A.—The capacity of steam room allowed by Boulton and Watt in their land waggon boilers is $8\frac{3}{4}$ cubic feet per horse power in the two horse power boiler, and $5\frac{3}{4}$ cubic feet in the 20 horse power boiler; and in the larger class of boilers, such as those suitable for 30 and 45 horse power engines, the capacity of the steam room does not fall below this amount, and indeed is nearer 6 than $5\frac{3}{4}$ cubic feet per horse power. The content of water is $18\frac{1}{2}$ cubic feet per horse power in the two horse power boiler, and 15 cubic feet per horse power in the 20 horse power boiler.

291. *Q.*—Is this the proportion Boulton and Watt allow in their marine boilers?

A.—Boulton and Watt in their early steam vessels were in the habit of allowing for the capacity of the steam space in marine boilers 16 times the content of the cylinder; but as there were two cylinders, this was equivalent to 8 times the content of both cylinders, which is the proportion commonly followed in land engines, and which agrees very nearly with the proportion of between 5 and 6 cubic feet of steam room per horse power already referred to. Taking for example an engine with 23 inches diameter of cylinder and 4 feet stroke, which will be 18·4 horse power—the area of the cylinder will be 415·476 square inches, which multiplied by 48, the number of

inches in the stroke, will give 19942·848 for the capacity of the cylinder in cubic inches; 8 times this is 159542·784 cubic inches, or 92·3 cubic feet; 92·3 divided by 18·4 is rather more than 5 cubic feet per horse power.

292. Q.—Is the production of the steam in the boiler uniform throughout the stroke of the engine?

A.—It varies with the slight variations in the pressure within the boiler throughout the stroke. Usually the larger part of the steam is produced during the first part of the stroke of the engine, for there is then the largest demand for steam as the steam being commonly cut off somewhat before the end of the stroke, the pressure rises somewhat in the boiler during that period, and little steam is then produced. There is less necessity that the steam space should be large when the flow of steam from the boiler is very uniform, as it will be where there are two engines attached to the boiler at right angles with one another, or where the engines work at a great speed, as in the case of locomotive engines. A high steam chest too, by rendering boiling over into the steam pipes, or priming as it is called, more difficult, obviates the necessity for so large a steam space; as does also a perforated steam pipe stretching through the length of the boiler, so as not to take the steam from one place. The use of steam of a high pressure, worked expansively, has the same operation; so that in modern marine boilers, of the tubular construction, where the whole or most of these modifying circumstances exist, there is no necessity for so large

a proportion of steam room as 5 or 6 cubic feet per nominal horse power, and about one $1\frac{1}{2}$ or 2 cubic feet of steam room per cubic foot of water evaporated, more nearly represents the general practice.

293. Q.—Is this the proportion of steam room adopted in locomotive boilers?

A.—No; in locomotive boilers the proportion of steam room per cubic foot of water evaporated is considerably less even than this. It does not usually exceed $\frac{1}{2}$ of a cubic foot per cubic foot of water evaporated; and with clean water, with a steam dome a few feet high set on the barrel of the boiler, or with a perforated pipe stretching from end to end of the barrel, and with the steam room divided about equally between the barrel and the fire box, very little priming is found to occur even with this small proportion of total steam room. About $\frac{3}{4}$ the depth of the barrel is usually filled with water, and $\frac{1}{4}$ with steam.

294. Q.—What is priming?

A.—Priming is a violent agitation of the water within the boiler, in consequence of which a large quantity of water passes off with the steam in the shape of froth or spray. Such a result is injurious, both as regards the efficacy of the engine, and the safety of the engine and boiler; for the large volume of hot water carried by the steam into the condenser impairs the vacuum, and throws a great load upon the air pump, which diminishes the speed and available power of the engine; and the existence of water within the cylinder, unless there be safety valves upon the cylinder to permit its escape, will very probably cause

some part of the machinery to break, by suddenly arresting the motion of the piston when it meets the surface of the water,—the slide valve being closed to the condenser before the termination of the stroke, in all engines with lap upon the valves, so that the water within the cylinder is prevented from escaping in that direction. At the same time the boiler is emptied of its water too rapidly for the feed pump to be able to maintain the supply, and the flues are in danger of being burnt from a deficiency of water above them.

295. Q.—What are the causes of priming?

A.—The causes of priming are an insufficient amount of steam room, an inadequate area of water level, an insufficient width between the flues or tubes for the ascent of the steam and the descent of water to supply the vacuity the steam occasions, and the use of dirty water in the boiler. New boilers prime more than old boilers, and steamers entering rivers from the sea are more addicted to priming than if sea or river water had alone been used in the boilers—probably from the boiling point of salt water being higher than that of fresh, whereby the salt water acts like so much molten metal in raising the fresh water into steam. Opening the safety valve suddenly may make a boiler prime, and if the safety valve be situated near the mouth of the steam pipe, the spray or foam thus created may be mingled with the steam passing into the engine, and materially diminish its effective power; but if the safety valve be situated at a distance from the mouth of the steam pipe, the quantity of foam or spray passing into the engine may be dimi-

nished by opening the safety valve ; and in locomotives, therefore, it is found beneficial to have a safety valve on the barrel of the boiler at a point remote from the steam chest, by partially opening which, any priming in that part of the boiler adjacent to the steam chest is checked, and a purer steam than before passes to the engine.

296. Q.—What is the proper remedy for priming ?

A.—When a boiler primes, the engineer generally closes the throttle valve partially, turns off the injection water, and opens the furnace doors, whereby the generation of steam is checked, and a less violent ebullition in the boiler suffices. Where the priming arises from an insufficient amount of steam room, it may be mitigated by putting a higher pressure upon the boiler and working more expansively, or by the interposition of a perforated plate between the boiler and the steam chest, which breaks the ascending water and liberates the steam. In some cases, however, it may be necessary to set a second steam chest on the top of the existing one, and it will be preferable to establish a communication with this new chamber by means of a number of small holes, bored through the iron plate of the boiler, rather than by a single large orifice. Where priming arises from the existence of dirty water in the boiler, the evil may be remedied by the use of collecting vessels, or by blowing off largely from the surface ; and where it arises from an insufficient area of water level, or an insufficient width between the flues for the free ascent of the steam and the descent of the superincumbent water, the evil may be abated by the addition of cir-

culating pipes in some part of the boiler which will allow the water to descend freely to the place from whence the steam rises, the width of the water spaces being virtually increased by restricting their function to the transmission of a current of steam and water to the surface. It is desirable to arrange the heating surface in such a way that the feed water entering the boiler at its lowest point is heated gradually as it ascends, until towards the superior part of the flues it is raised gradually into steam ; but in all cases there will be currents in the boiler for which it is proper to provide. The steam pipe proceeding to the engine should obviously be attached to the highest point of the steam chest, in boilers of every construction.

297. *Q.*—Having now stated the proportions proper to be adopted for evaporating any given quantity of water in steam boilers, will you proceed to show how you would proportion a boiler to do a given amount of work ? say a locomotive boiler which will propel a train of 100 tons weight at a speed of 50 miles an hour.

A.—According to experiments on the resistance of railway trains at various rates of speed made by Mr. Gooch, of the Great Western Railway, it appears that a train weighing with locomotive, tender, and carriages, about 100 tons, experiences, at a speed of 50 miles an hour, a resistance of about 3000 lbs., or about 30 lbs. per ton ; which resistance includes the resistance of the engine as well as that of the train. This, therefore, is the force which must be imparted at the circumference of the driving wheels, except that small part intercepted by the engine itself, and

the force exerted by the pistons must be greater than that at the circumference of the driving wheel, in the proportion of their slower motion, or in the proportion of the circumference of the driving wheel to the length of a double stroke of the engine. If the diameter of the driving wheel be $5\frac{1}{2}$ feet, its circumference will be 17.278 feet, and if the length of the stroke be 18 inches the length of a double stroke will be 3 feet. The pressure on the pistons must therefore be greater than the traction at the circumference of the driving wheel, in the proportion of 17.278 to 3, or, in other words, the mean pressure on the pistons must be 17,278 lbs; and the area of cylinders, and pressure of steam, must be such as to produce conjointly this total pressure. It thus becomes easy to tell the volume and pressure of steam required, which steam in its turn represents its equivalent of water which is to be evaporated from the boiler, and the boiler must be so proportioned, by the rules already given, as to evaporate this water freely. In the case of a steam vessel the mode of procedure is the same, and when the resistance and speed are known, it is easy to tell the equivalent value of steam.

STRENGTH OF BOILERS.

298. Q.—What strain should the iron of boilers be subjected to in working?

A.—The iron of boilers, like the iron of machines or structures, is capable of withstanding a tensile strain of from 50,000 to 60,000 lbs. upon every square inch

of section ; but it will only bear a third of this strain without permanent derangement of structure, and it does not appear expedient in any boiler to let the strain exceed 4000 lbs. upon the square inch of sectional area of metal, especially if it is liable to be weakened by corrosion.

299. Q.— Have any experiments been made to determine the strength of boilers ?

A.— The question of the strength of boilers was investigated very elaborately a few years ago by a committee of the Franklin Institute, in America, and it was found that the tenacity of boiler plate increased with the temperature up to 550° , at which point the tenacity began to diminish. At 32° , the cohesive force of a square inch of section was 56,000 lbs. ; at 570° , it was 66,500 lbs. ; at 720° , 55,000 lbs. ; at 1050° , 32,000 lbs. ; at 1240° , 22,000 lbs. ; and at 1317° , 9000 lbs. Copper follows a different law, and appears to be diminished in strength by every addition to the temperature. At 32° the cohesion of copper was found to be 32,800 lbs. per square inch of section, which exceeds the cohesive force at any higher temperature, and the square of the diminution of strength seems to keep pace with the cube of the increased temperature. Strips of iron cut in the direction of the fibre were found to be about 6 per cent. stronger than when cut across the grain. Repeated piling and welding was found to increase the tenacity of the iron, but the result of welding together different kinds of iron was not found to be favourable. The accidental overheating of a boiler was found to reduce the ultimate or maximum strength of the plates from 65,000 lbs. to

45,000 lbs. per square inch of section, and riveting the plates was found to occasion a diminution in their strength to the extent of one-third. These results, however, are not precisely the same as those obtained by Mr. Fairbairn.

300. Q.—What were the results obtained by him?

A.—He found that boiler plate bore a tensile strain of 23 tons per square inch before rupture, which was reduced to 16 tons per square inch when joined together by a double row of rivets, and 13 tons, or about 30,000, when joined together by a single row of rivets. A circular boiler, therefore, with the ends of its plates double riveted, will bear at the utmost about 36,000 lbs. per square inch of section, or about 12,000 lbs. per square inch of section without permanent derangement of structure.

301. Q.—What pressure do cylindrical boilers sustain in practice?

A.—In some locomotive boilers, which are worked with a pressure of 80 lbs. upon the square inch, the thickness of the plates is only $\frac{5}{16}$ ths of an inch, while the barrel of the boiler is 39 inches in diameter. It will require a length of 3.2 inches of the boiler when the plates are $\frac{5}{16}$ ths thick to make up a sectional area of one square inch, and the separating force will be 39 times 3.2 multiplied by 80, which makes the separating force 9984 lbs., sustained by two square inches of sectional area—one on each side; or the strain is 4992 lbs. per square inch of sectional area, which is quite as great strain as is advisable. The accession of strength derived from the boiler ends is not here

taken into account, but neither is the weakening effect counted that is caused by the rivet holes. Some locomotives of 4 ft. diameter of barrel and of $\frac{3}{8}$ ths iron have been worked to as high a pressure as 200 lbs. on the inch ; but such feats of daring are neither to be imitated nor commended.

302. Q.— Can you give a rule for the proper thickness of cylindrical boilers ?

A.— The thickness proper for cylindrical boilers of wrought iron, exposed to an internal pressure, may be found by the following rule :—multiply 2.54 times the internal diameter of the cylinder in inches by the greatest pressure within the cylinder per circular inch, and divide by 17,800 ; the result is the thickness in inches. If we apply this rule to the example of the locomotive boiler just given, we have $39 \times 2.54 \times 62.832$ (the pressure per circular inch corresponding to 80 lbs. per square inch) = 6224.1379, and this, divided by 17,800, gives 0.349 as the thickness in inches, instead of 0.3125, or $\frac{5}{16}$ ths, the actual thickness. If we take the pressure per square inch instead of per circular inch, we obtain the following rule, which is somewhat simpler :—multiply the internal diameter of the cylinder in inches by the pressure in pounds per square inch, and divide the product by 8900 ; the result is the thickness in inches. Both these rules give the strain about one-fourth of the elastic force, or 4450 lbs. per square inch of sectional area of the iron ; but 3000 lbs. is enough when the flame impinges directly on the iron, as in some of the ordinary cylindrical boilers, and the rule may be adapted for that strain by taking 6000 as a divisor instead of 8900.

303. Q.—In marine and waggon boilers which are not of a cylindrical form, how do you procure the requisite strength?

A.—Where the sides of the boiler are flat, instead of being cylindrical, a sufficient number of stays must be introduced to withstand the pressure; and it is expedient not to let the strain upon these stays be more than 3000 lbs. per square inch of section, as the strength of internal stays in boilers is generally soon diminished by corrosion. Indeed, a strain at all approaching that upon locomotive boilers would be very unsafe in the case of marine boilers, on account of the corrosion, both internal and external, to which marine boilers are subject. The stays should be small and numerous rather than large and few in number, as, when large stays are employed, it is difficult to keep them tight at the ends, and oxidation of the shell follows from leakage at the ends of the stays. All boilers should be proved, when new, to twice or three times the pressure they are intended to bear, and they should be proved occasionally by the hand pump when in use, to detect any weakness which corrosion may have occasioned.

304. Q.—Will you describe the disposition of the stays in a marine boiler?

A.—If the pressure of steam be 20 lbs. on the square inch, which is a very common pressure in tubular boilers, there will be a pressure of 2880 lbs. on every square foot of flat surface; so that if the strain upon the stays is not to exceed 3000 lbs. on the square inch of section, there must be nearly a square inch of sectional area of stay for every square foot of flat

surface on the top and bottom, sides, and ends of the boiler. This very much exceeds the proportion usually adopted; and in scarcely any instance are boilers stayed sufficiently to be safe when the shell is composed of flat surfaces. The furnaces should be stayed together with bolts of the best scrap iron, $1\frac{1}{4}$ inch in diameter, tapped through both plates of the water space with thin nuts in each furnace; and it is expedient to make the row of stays, running horizontally near the level of the bars, sufficiently low to come beneath the top of the bars, so as to be shielded from the action of the fire, with which view they should follow the inclination of the bars. The row of stays between the level of the bars and the top of the furnace should be as near the top of the furnace as will consist with the functions they have to perform, so as to be removed as far as possible from the action of the heat; and to support the furnace top, cross bars may either be adopted, to which the top is secured with bolts, as in the case of locomotives, or stays tapped into the furnace top, with a thin nut beneath, may be carried to the top of the boiler; but very little dependence can be put in such stays as stays for keeping down the top of the boiler; and the top of the boiler must, therefore, be stayed nearly as much as if the stays connecting it with the furnace crowns did not exist. The large rivets passing through thimbles, sometimes used as stays for water spaces or boiler shells, are objectionable; as, from the great amount of hammering such rivets have to receive to form the heads, the iron becomes crystalline, so that the heads are liable to come off, and, indeed, sometimes fly off

in the act of being formed. If such a fracture occurs between the boilers after they are seated in their place, or in any position not accessible from the outside, it will in general be necessary to empty the faulty boiler, and repair the defect from the inside.

305. Q.—What should be the pitch or numerical distribution of the stays?

A.—The stays, where the sides of the boiler are flat, and the pressure of the steam is from 20 to 30 lbs., should be pitched about a foot or 18 inches asunder; and in the wake of the tubes, where stays cannot be carried across to connect the boiler sides, angle iron ribs, like the ribs of a ship, should be riveted to the interior of the boiler, and stays of greater strength than the rest should pass across, above, and below the tubes, to which the angle irons would communicate the strain. The whole of the long stays within a boiler should be firmly riveted to the shell, as if built with and forming a part of it; as, by the common method of fixing them in by means of cutters, the decay or accidental detachment of a pin or cutter may endanger the safety of the boiler. Wherever a large perforation in the shell of any circular boiler occurs, a sufficient number of stays should be put across it to maintain the original strength; and where stays are intercepted by the root of the funnel, short stays in continuation of them should be placed inside.

BOILER EXPLOSIONS.

306. Q.—What is the chief cause of boiler explosions?

A.—The chief cause of boiler explosions is, undoubtedly, too great a pressure of steam, or an insufficient strength of boiler; but many explosions have also arisen from the flues having been suffered to become red hot. If the safety valve of a boiler be accidentally jammed, or if the plates or stays be much worn by corrosion, while a high pressure of steam is nevertheless maintained, the boiler necessarily bursts; and if, from an insufficiency of water in the boiler, or from any other cause, the flues become highly heated, they may be forced down by the pressure of the steam, and a partial explosion may be the result. The worst explosion is where the shell of the boiler bursts; but the collapse of a furnace or flue is also very disastrous generally to the persons in the engine room; and sometimes the shell bursts and the flues collapse at the same time; for if the flues get red hot, and water be thrown upon them either by the feed pump or otherwise, the generation of steam may be too rapid for the safety valve to permit its escape with sufficient facility, and the shell of the boiler may, in consequence, be rent asunder. Sometimes the iron of the flues becomes highly heated in consequence of the improper configuration of the parts, which, by retaining the steam in contact with the metal, prevents the access of the water: the bottoms of large flues, upon which the flame beats down, are very liable to injury from this cause; and the iron of flues thus acted upon may be so softened that the flues will collapse upwards with the pressure of the steam. The flues of boilers may also become red hot in some parts from the attachment of scale, which, from its imperfect conducting power,

will cause the iron to be unduly heated; and if the scale be accidentally detached, a partial explosion may occur in consequence.

307. Q.— Does the contact of water with heated metal occasion an instantaneous generation of steam?

A.— It is found that a sudden disengagement of steam does not immediately follow the contact of water with the hot metal, for water thrown upon red hot iron is not immediately converted into steam, but assumes the spheroidal form and rolls about in globules over the surface. These globules, however high the temperature of the metal may be on which they are placed, never rise above the temperature of 205° , and give off but very little steam; but if the temperature of the metal be lowered, the water ceases to retain the spheroidal form, and comes into intimate contact with the metal, whereby a rapid disengagement of steam takes place. If water be poured into a very hot copper flask, the flask may be corked up, as there will be scarce any steam produced so long as the high temperature is maintained; but so soon as the temperature is suffered to fall below 350° or 400° , the spheroidal condition being no longer maintainable, steam is generated with rapidity, and the cork will be projected from the mouth of the flask with great force.

308. Q.— What precautions can be taken to prevent boiler explosions?

A.— One useful precaution against the explosion of boilers from too great an internal pressure, consists in the application of a steam gauge to each boiler, which will make the existence of any undue pressure

in any of the boilers immediately visible; and every boiler should have a safety valve of its own, the passage leading to which should have no connection with the passage leading to any of the stop valves used to cut off the connection between the boilers; so that the action of the safety valve may be made independent of the action of the stop valve. In some cases stop valves have jammed, or have been carried from their seats into the mouth of the pipe communicating between them, and the action of the safety valves should be rendered independent of all such accidents. Safety valves, themselves, sometimes stick fast from corrosion, from the spindles becoming bent, from a distortion of the boiler top with a high pressure, in consequence of which the spindles become jammed in the guides, and from various other causes which it would be tedious to enumerate; but the inaction of the safety valves is at once indicated by the steam gauge, and when discovered, the blow through valves of the engine and blow off cocks of the boiler should at once be opened, and the fires raked out. A cone in the ball of the waste steam pipe to send back the water carried upwards by the steam, should never be inserted; as in some cases this cone has become loose, and closed up the mouth of the waste steam pipe, whereby the safety valves being rendered inoperative the boiler was in danger of bursting.

309. Q. — May not danger arise from excessive priming?

A. — If the water be carried out of the boiler so rapidly by priming that the level of the water cannot be maintained, and the flues or furnaces are in danger

of becoming red hot, the best plan is to open every furnace door and throw in a few buckets full of water upon the fire, taking care to stand sufficiently to the one side to avoid being scalded by the rush of steam from the furnace. There is no time to begin drawing the fires in such an emergency, and by this treatment the fires, though not altogether extinguished, will be rendered incapable of doing harm. If the flues be already red hot, on no account must cold water be suffered to enter the boiler, but the heat should be maintained in the furnaces, and the blow off cocks be opened, or the mud hole doors loosened, so as to let all the water escape; but at the same time the pressure must be kept quite low in the boiler, so that there will be no danger of the hot flues collapsing with the pressure of the steam.

310. Q.—Are plugs of fusible metal useful in preventing explosions?

A.—Plugs of fusible metal were at one time in much repute as a precaution against explosion, the metal being so compounded that it melted with the heat of high pressure steam; but the device, though ingenious, has not been found of any utility in practice. The basis of fusible metal is mercury, and it is found that the compound is not homogeneous, and that the mercury is forced by the pressure of the steam out of the interstices of the metal combined with it, leaving a porous metal which is not easily fusible, and which is, therefore, unable to perform its intended function. In locomotives, however, and also in some other boilers, a lead rivet is inserted with advantage in the crown of the fire box which is

melted out if the water becomes too low, and thus gives notice of the danger.

311. Q.—May not explosion occur in marine boilers from the accumulation of salt on the flues?

A.—Yes, in marine boilers this is a constant source of danger which is only to be met by attention on the part of the engineer. If the water in the boiler be suffered to become too salt, an incrustation of salt will take place on the furnaces, which may cause them to become red hot, and they may then be collapsed even by their own weight aided by a moderate pressure of steam. The expedients which should be adopted for preventing such an accumulation of salt from taking place within the boiler as will be injurious to it, properly fall under the head of the management of steam boilers, and will be explained in a subsequent chapter.

CHAP. VI.

PROPORTIONS OF ENGINES.

STEAM PASSAGES.

312. *Q.*—What size of orifice is commonly allowed for the escape of the steam through the safety valve in low pressure engines?

A.—About 0·8 of a circular inch per horse power, or a circular inch per $1\frac{1}{4}$ horse power. The following rule, however, will give the dimensions suitable for all kinds of engines, whether high or low pressure:—multiply the square of the diameter of the cylinder in inches by the speed of the piston in feet per minute, and divide the product by 375 times the pressure on the boiler per square inch; the quotient is the proper area of the safety valve in square inches. This rule of course supposes that the evaporating surface has been properly proportioned to the engine power.

313. *Q.*—Is this rule applicable to locomotives?

A.—It is applicable to high pressure engines of every kind. The dimensions of safety valves, however, in practice are very variable, being in some cases greater, and in some cases less, than what the rule gives, the consideration being apparently as often what proportions will best prevent the valve from

MODE OF DEDUCT

engine is worked exp
pressure of steam.

asing engines, hov
pressure of from 4 to

ea of the steam pip
horse power. In

e steam pipe may b
vide the number of

tract the square ro
e internal diameter

319. Q.—Will yo
omputation these pr

A.—The size of th
ere will be no ma

een the cylinder ar
the eduction pass

w. When the dis
locity with which

easy to tell what t
eam pipe will be; f

times greater the
eam in the steam p

an the piston, and
isite to produce t

ily be ascertained, l
steam must be to g

ight or pressure is
wever, this proporti

ndensation of steam

320. Q.—If the re
t between the area

ocity of the pisto
rger when the piston

The scanning operator will
notify their lead when a
page is found torn or is torn
by the operator.

Book Details

- Scannable
- Unscannable

Details

- Fold-Outs/Unscannable material within book
- Tight Gutter
- Text in Gutter
- Other (circle one)
- Missing Pages
- Misprint
- Pages Stuck Together
- Multi-work

and the lever by which they are pressed down is generally graduated in the proportion of the area of the valve to unity; that is, in the case of a valve of 12 inches area, the long end of the lever to which the spring balance is attached is 12 times the length of the short end, so that the weight or pressure on the balance shows the pressure per square inch on the boiler. In some cases, however, a spiral spring, and in other cases a pile of elliptical springs, is placed directly upon the top of the valve, and it appears desirable that one of the valves at least should be loaded in this manner. It is difficult when the lever is divided in such a proportion as 12 to 1, to get sufficient lift of the valve without a large increase of pressure on the spring; and it appears expedient, therefore, to employ a shorter lever, which involves either a reduction in the area of the valve, or an increased strength in the spring.

318. Q.—What are the proper dimensions of the steam passages?

A.—In slow working engines the common size of the cylinder passages is one-twenty-fifth of the area of the cylinder, or one-fifth of the diameter of the cylinder, which is the same thing. This proportion corresponds very nearly with one square inch per horse power when the length of the cylinder is about equal to its diameter; and one square inch of area per horse power for the cylinder ports and eduction passages answers very well in the case of engines working at the ordinary speed of 220 feet per minute. The area of the steam pipe is usually made less than the area of the eduction pipe, especially when the

engine is worked expansively, and with a considerable pressure of steam. In the case of ordinary condensing engines, however, working with the usual pressure of from 4 to 8 lbs. above the atmosphere, the area of the steam pipe is not less than a circular inch per horse power. In such engines the diameter of the steam pipe may be found by the following rule: divide the number of nominal horse power by 0·8 and extract the square root of the quotient, which will be the internal diameter of the steam pipe.

319. *Q.*—Will you explain by what process of computation these proportions are arrived at?

A.—The size of the steam pipe is so regulated that there will be no material disparity of pressure between the cylinder and boiler; and in fixing the size of the eduction passage the same object is kept in view. When the diameter of the cylinder and the velocity with which the piston travels are known, it is easy to tell what the velocity of the steam in the steam pipe will be; for if the area of the cylinder be 25 times greater than that of the steam pipe, the steam in the steam pipe must travel 25 times faster than the piston, and the difference of pressure requisite to produce this velocity of the steam can easily be ascertained, by finding what height a column of steam must be to give that velocity, and what the weight or pressure is of such a column. In practice, however, this proportion is always exceeded from the condensation of steam in the pipe.

320. *Q.*—If the relation you have mentioned subsist between the area of the steam passages and the velocity of the piston, then the passages must be larger when the piston travels very rapidly?

A.—And they are so made. The area of the ports of locomotive engines is usually so proportioned as to be from $\frac{1}{10}$ th to $\frac{1}{4}$ th the area of the cylinder—in some cases even as much as $\frac{1}{2}$ th; and in all high speed engines the ports should be very large, and the valve should have a good deal of travel so as to open the port very quickly. The area of port which it appears advisable to give to modern engines of every description, is expressed by the following rule:—multiply the area of the cylinder in square inches by the speed of the piston in feet per minute, and divide the product by 4000; the quotient is the area of each cylinder port in square inches. This rule gives rather more than a square inch of port per nominal horse power to condensing engines working at the ordinary speed; but the excess is but small, and is upon the right side. For engines travelling very fast it gives a good deal more area than the common proportion, which is too small in nearly every case. In locomotive engines the eduction pipe passes into the chimney and the force of the issuing steam has the effect of maintaining a rapid draught through the furnace as before explained. The orifice of the waste steam pipe, or the blast pipe as it is termed, is much contracted in some engines with the view of producing a fiercer draught, and an area of $\frac{1}{3}$ rd of the of the cylinder is a common proportion; but this is as much contraction as should be allowed, and is greater than is advisable.

321. *Q.*—In engines moving at a high rate of speed, you have stated that it is important to give the valve lead, or in other words to allow the steam to escape before the end of the stroke?

A.—Yes, this is very important, else the piston will have to force out the steam from the cylinder, and will be much resisted. Near the end of the stroke the piston begins to travel slowly, and if the steam, be then permitted to escape, very little of the effective stroke is lost, and time is afforded to the steam, before the motion of the piston is again accelerated, to make its escape by the port. In some locomotives, from inattention to this adjustment and from a contracted area of tube section, which involved a strong blast, about half the power of the engine has been lost; but in more recent engines, by using enlarged ports and by giving sufficient lead, this loss has been greatly diminished.

322. *Q.*—What do you call sufficient lead?

A.—In fast going engines I would call it sufficient lead, when the eduction port was nearly open at the end of the stroke.

323. *Q.*—Can you give any example of the benefit of increasing the lead?

A.—The early locomotives were made with very little lead, and the proportions were in fact very much the same as those previously existing in land engines. About 1832, the benefits of lap upon the valve, which had been employed by Boulton and Watt more than twenty years before, were beginning to be pretty generally apprehended; and, in the following year, this expedient of economy was applied to the steamer Manchester, in the Clyde, and to some other vessels, with very marked success. Shortly after this time, lap began to be applied to the valves of locomotives, and it was found that not only was there a benefit from

the operation of expansion, but that there was a still greater benefit from the superior facility of escape given to the steam, inasmuch as the application of lap involved the necessity of turning the eccentric round upon the shaft, which caused the eduction to take place before the end of the stroke. In 1840, one of the engines of the Liverpool and Manchester Railway was altered so as to have 1 inch lap on the valve, and 1 inch opening on the eduction side at the end of the stroke, the valve having a total travel of $4\frac{1}{4}$ inches. The consumption of fuel per mile fell from 36·3 lbs. to 28·6 lbs., or about 25 per cent., and a softer blast sufficed. By using larger exhaust passages, larger tubes, and closer fire bars, the consumption was subsequently brought down to 15 lbs. per mile.

AIR PUMP, CONDENSER, AND HOT AND COLD WATER PUMPS.

324. Q.—Will you state the proper dimensions of the air pump and condenser in land and marine engines?

A.—Mr. Watt made the air pump of his engine half the diameter of the cylinder and half the stroke, or one-eighth of the capacity, and the condenser was usually made about the same size as the air pump; but as the pressure of the steam has been increased in all modern engines, it is better to make the air pump a little larger than this proportion. 0·6 of the diameter of the cylinder and half the stroke answers very well, and the condenser may be made as large as it can be got with convenience, though the same size as the air pump will suffice.

325. Q.—Are air pumps now sometimes made double acting?

A.—Most of the recent direct acting marine engines for driving the screw are fitted with a double acting air pump, and when the air pump is double acting, it need only be about half the size that is necessary when it is single acting. It is single acting in nearly every case, except the case of direct acting screw engines of recent construction.

326. Q.—What is the difference between a single and a double acting air pump?

A.—The single acting air pump expels the air and water from the condenser only in the upward stroke of the pump, whereas a double acting air pump expels the air and water both in the upward and downward stroke. It has, therefore, to be provided with inlet and outlet valves at both ends, whereas the single acting pump has only to be provided with an inlet or foot valve, as it is termed, at the bottom, and with an outlet or delivery valve, as it is termed, at the top. The single acting air pump requires to be provided with a valve or valves in the piston or bucket of the pump to enable the air and water lying below the bucket when it begins to descend, and which have entered from the condenser during the upward stroke, to pass through the bucket into the space above it during the downward stroke, from whence they are expelled into the atmosphere on the upward stroke succeeding. But in the double acting air pump no valve is required in the piston or bucket of the pump, and all that is necessary is an inlet and outlet valve at each end.

327. Q.—What are the dimensions of the foot and discharge valves of the air pump?

A.—The area through the foot and discharge valves is usually made equal to one-fourth of the area of the air pump, and the diameter of the waste water pipe is made one-fourth of the diameter of the cylinder, which gives an area somewhat less than that of the foot and discharge valve passages. But this proportion only applies in slow engines. In fast engines, with the air pump bucket moving as fast as the piston, the area through the foot and discharge valves should be equal to the area of the pump itself, and the waste water pipe should be of about the same dimensions.

328. Q.—You have stated that double acting air pumps need only be of half the size of single acting ones. Does that relation hold at all speeds?

A.—It holds at all speeds if the velocity of the pump buckets are in each case the same; but it does not hold if the engine with the single acting pump works slowly, and the engine with the double acting pump moves rapidly, as in the case of direct acting screw engines. All pumps moving at a high rate of speed lose part of their efficiency, and such pumps should therefore be of extra size.

329. Q.—How do you estimate the quantity of water requisite for condensation?

A.—Mr. Watt found that the most beneficial temperature of the hot well of his engines was 100 degrees. If, therefore, the temperature of the steam be 212° , and the latent heat 1000° , then 1212° may be taken to represent the heat contained in the steam, or 1112° if we deduct the temperature of the hot well. If the

temperature of the injection water be 50° , then 50 degrees of cold are available for the abstraction of heat, and as the total quantity of heat to be abstracted is that requisite to raise the quantity of water in the steam 1112 degrees, or 1112 times that quantity one degree, it would raise one-fiftieth of this, or 22·24 times the quantity of water in the steam 50° degrees. A cubic inch of water therefore raised into steam will require 22·24 cubic inches of water at 50° degrees for its condensation, and will form therewith 23·24 cubic inches of hot water at 100° degrees. Mr. Watt's practice was to allow about a wine pint (28·9 cubic inches) of injection water, for every cubic inch of water evaporated from the boiler.

330. Q.—Is not a good vacuum in an engine conducive to increased power?

A.—It is.

331. Q.—And is not the vacuum good in the proportion in which the temperature is low, supposing there to be no air leaks?

A.—Yes.

332. Q.—Then how could Mr. Watt find a temperature of 100° in the water drawn from the condenser, to be more beneficial than a temperature of 70° or 80° , supposing there to be an abundant supply of cold water?

333. A.—Because the superior vacuum due to a temperature of 70° or 80° involves the admission of so much cold water into the condenser, which has afterwards to be pumped out in opposition to the pressure of the atmosphere, that the gain in the vacuum does not equal the loss of power occasioned by the addi-

tional load upon the pump, and there is therefore a clear loss by the reduction of the temperature below 100°, if such reduction be caused by the admission of an additional quantity of water. If the reduction of temperature, however, be caused by the use of colder water, there is a gain produced by it, though the gain will within certain limits be greater if advantage be taken of the lowness of the temperature to diminish the quantity of injection.

334. Q.—How do you determine the proper area of the injection orifice?

A.—The area of the injection orifice proper for any engine can easily be told when the quantity of water requisite to condense the steam is known, and the pressure is specified under which the water enters the condenser. The vacuum in the condenser may be taken at 26 inches of mercury which is equivalent to a column of water 29·4 ft. high, and the square root of 29·4 multiplied by 8·021 is 43·15, which is the velocity in feet per second that a heavy body would acquire in falling 29·4 ft., or with which the water would enter the condenser. Now, if a cubic foot of water evaporated per hour be equivalent to an actual horse power, and 28·9 cubic inches of water be requisite for the condensation of a cubic inch of water in the form of steam, 28·9 cubic feet of condensing water per horse power per hour, or 13·905 cubic inches per second, will be necessary for the engine, and the size of the injection orifice must be such that this quantity of water flowing with the velocity of 43·15 ft. per second, or 517·8 inches per second, will gain admission to the condenser. Dividing, therefore, 13·905, the number of

cubic inches to be injected, by 517·8 the velocity of influx in inches per second, we get 0·02685 for the area of the orifice in square inches; but inasmuch as it has been found by experiment that the actual discharge of water through a hole in a thin plate is only six-tenths of the theoretical discharge on account of the contracted vein, the area of the orifice must be increased in the proportion of such diminution of effect, or be made 0·04475, or $\frac{1}{22}$ nd of a square inch per horse power. This, it will be remarked, is the theoretical area required per actual horse power; but as the friction and contractions in the pipe further reduce the discharge, the area is made $\frac{1}{18}$ th of a square inch per actual horse power or rather per cubic foot of water evaporated from the boiler.

335. Q.—Cannot the condensation of the steam be accomplished by any other means than by the admission of cold water into the condenser?

A.—It may be accomplished by the method of external cold, as it is called, which consists in the application of a large number of thin metallic surfaces to the condenser, on the one side of which the steam circulates, while on the other side there is a constant current of cold water, and the steam is condensed by coming into contact with the cold surfaces, without mingling with the water used for the purpose of refrigeration. The first kind of condenser employed by Mr. Watt was constructed after this fashion, but he found it in practice to be inconvenient from its size, and to become furred up or incrustated when the water was bad, whereby the conducting power of the metal was impaired. He therefore reverted to the use of

the jet of cold water, as being upon the whole preferable. The jet entered the condenser instead of the cylinder, as was the previous practice, and this method is now the one in common use. Several years ago, a good number of steam vessels were fitted with Hall's condensers, which operated on the principle of external cold, and which consisted of a faggot of small copper tubes surrounded by water; but the use of those condensers was relinquished. Latterly, however, the plan has been revived, and is now widely employed.

336. Q.—You stated that the capacity of the feed pump was $\frac{1}{40}$ th of the capacity of the cylinder in the case of condensing engines,—the engine being double acting and the pump single acting,—and that in high pressure engines the capacity of the pump should be greater in proportion to the pressure of the steam. Can you give any rule that will express the proper capacity for the feed pump at all pressures?

A.—That will not be difficult. In low pressure engines the pressure in the boiler may be taken at 5 lbs. above the atmospheric pressure, or 20 lbs. altogether; and as high pressure steam is merely low pressure steam compressed into a smaller compass, the size of the feed pump in relation to the size of the cylinder must obviously vary in the direct proportion of the pressure; and if it be $\frac{1}{40}$ th of the capacity of the cylinder when the total pressure of the steam is 20 lbs., it must be $\frac{1}{10}$ th of the capacity of the cylinder when the pressure is 40 lbs. per square inch, or 25 lbs. per square inch above the atmospheric pressure. This law of variation is expressed by the following rule:—mul-

multiply the capacity of the cylinder in cubic inches by the total pressure of the steam in lbs. per square inch, or the pressure per square inch on the safety valve plus 15, and divide the product by 4800; the quotient is the capacity of the feed pump in cubic inches, when the feed pump is single acting and the engine double acting. If the feed pump be double acting, or the engine single acting, the capacity of the pump must just be one-half of what is given by this rule.

337. Q.—But should not some addition be made to the size of pump thus obtained if the pump works at a high rate of speed?

A.—No; this rule makes allowance for defective action. All pumps lift much less water than is due to the size of their barrels and the number of their strokes. Moderately good pumps lose 50 per cent. of their theoretical effect, and bad pumps 80 per cent.

338. Q.—To what is this loss of effect to be chiefly ascribed?

A.—Mainly to the inertia of the water, which, if the pump piston be drawn up very rapidly, cannot follow it with sufficient rapidity; so that there may be a vacant space between the piston and the water; and at the return stroke the momentum of the water in the pipe expends itself in giving a reverse motion to the column of water approaching the pump. Messrs. Kirchweyer and Prusman, of Hanover, have investigated this subject by applying a revolving cock at the end of a pipe leading from an elevated cistern containing water, and the water escaped at every revolution of the cock in the same manner as if a pump

were drawing it. With a column of water of 17 feet, they found that at 80 revolutions of the cock per minute, the water delivered per minute by the cock was 9·45 gallons; but with 140 revolutions of the cock per minute, the water delivered per minute by the cock was only 5·42 gallons. They subsequently applied an air vessel to the pipe beside the cock, when the discharge rose to 12·9 gallons per minute with 80 revolutions, and 18·28 gallons with 140 revolutions. Air vessels should therefore be applied to the suction side of fast moving pumps, and the suction pipe should be made as short as possible.

339. Q.—What are the usual dimensions of the cold water pump of land engines?

A.—If to condense a cubic inch of water raised into steam 28·9 cubic inches of condensing water are required, then the cold water pump ought to be 28·9 times larger than the feed pump, supposing that its losses were equally great. The feed pump, however, is made sufficiently large to compensate for leaks in the boiler and loss of steam through the safety valve, so that it will be sufficient if the cold water pump be 24 times larger than the feed pump. This ratio is preserved by the following rule:—multiply the capacity of the cylinder in cubic inches by the total pressure of the steam per square inch, or the pressure on the safety valve plus 15, and divide the product by 200. The quotient is the proper capacity of the cold water pump in cubic inches when the engine is double acting, and the pump single acting.

FLY WHEEL.

340. Q.—By what considerations do you determine the dimensions of the fly wheel of an engine?

A.—By a reference to the power generated, each half stroke of the engine, and the number of half strokes that are necessary to give to the fly wheel its standard velocity, supposing the whole power devoted to that object. In practice the power resident in the fly varies from $2\frac{1}{2}$ to 6 times that generated each half stroke; and if the weight of the wheel be equal to the pressure on the piston, its velocity must be such as it would acquire by falling through a height equal to from $2\frac{1}{2}$ to 6 times the stroke, according to the purpose for which the engine is intended. If a very equable motion is required, a heavier or swifter fly wheel must be employed.

341. Q.—What is Boulton and Watt's rule for fly wheels?

A.—Their rule is one which under any given circumstances fixes the sectional area of the fly wheel rim, and it is as follows:—multiply 44,000 times the square of the diameter of the cylinder in inches by the length of the stroke in feet, and divide this product by the product of the square of the number of revolutions of the fly wheel per minute, multiplied by the cube of its diameter in feet. The quotient is the area of section of the fly wheel rim in square inches.

STRENGTHS OF LAND ENGINES.

342. Q.—Can you give a rule for telling the proper thickness of the cylinders of steam engines?

A.—In low pressure engines the thickness of metal

of the cylinder, in engines of a medium size, should be about $\frac{1}{16}$ th of the diameter of the cylinder, which, with a pressure of steam of 20 lbs. above the atmosphere, will occasion a strain of only 400 lbs. per square inch of section of the metal; the thickness of the metal of the trunnion bearings of oscillating engines should be $\frac{1}{32}$ nd of the diameter of the cylinder, and the breadth of the bearing should be about half its diameter. In high pressure engines the thickness of the cylinder should be about $\frac{1}{8}$ th its diameter, which, with a pressure of steam of 80 lbs. upon the square inch, will occasion a strain of 640 lbs. upon the square inch of section of the metal; and the thickness of the metal of the trunnion bearings of high pressure oscillating engines should be $\frac{1}{16}$ th of the diameter of the cylinder. The strength, however, is not the sole consideration in proportioning cylinders, for they must be made of a certain thickness, however small the pressure is within them, that they may not be too fragile, and will stand boring. While, also, an engine of 40 inches diameter would be about one inch thick, the thickness would not be quite two inches in an 80 inch cylinder. In fact there will be a small constant added to the thickness for all diameters, which will be relatively larger the smaller the cylinders become. In the engines of Penn's 12 horse power engines, the diameter of cylinder being $21\frac{1}{2}$ inches, the thickness of the metal is $\frac{9}{16}$ ths: in Penn's 40 inch cylinders, the thickness is 1 inch, and in the engines of the Ripon, Pottinger, and Indus, by Messrs. Miller, Ravenhill, and Co., with cylinders 76 inches diameter, the thickness of the metal is $1\frac{1}{8}$. These are all oscillating engines.

343. Q.—What is the proportion of the piston rod?

A.—The diameter of the piston rod is usually made $\frac{1}{10}$ th of the diameter of the cylinder, or the sectional area of the piston rod is $\frac{1}{100}$ th of the area of the cylinder. This proportion, however, is not applicable to locomotive, or even fast moving marine engines. In locomotive engines the piston rod is made $\frac{1}{4}$ th of the diameter of the cylinder, and it is obvious that where the pressure on the piston is great, the piston rod must be larger than when the pressure on the piston is small.

344. Q.—What are the proper dimensions of the main links of a land beam engine?

A.—The sectional area of the main links in land beam engines is $\frac{1}{13}$ th of the area of the cylinder, and the length of the main links is usually half the length of the stroke.

345. Q.—What are the dimensions of the connecting rod of a land engine?

A.—In land engines the connecting rod is usually of cast iron with a cruciform section: the breadth across the arms of the cross is about $\frac{1}{10}$ th of the length of the rod, the sectional area at the centre $\frac{1}{8}$ th of the area of the cylinder, and at the ends $\frac{1}{8}$ th of the area of the cylinder: the length of the rod is usually $3\frac{1}{2}$ times the length of the stroke. It is preferable, however, to make the connecting rod of malleable iron, and then the dimensions will be those proper for marine engines.

346. Q.—What was Mr. Watt's rule for the connecting rod?

A.—Some of his connecting rods were of iron and

some of wood. To determine the thickness when of wood, multiply the square of the diameter of the cylinder in inches by the length of the stroke in feet, and divide the product by 24. Extract the fourth root of the quotient, which is the thickness in inches. For iron the rule is the same, only the divisor was 57.6 instead of 24.

347. Q.—What are the dimensions of the end studs of a land engine beam?

A.—In low pressure engines the diameter of the end studs of the engine beam are usually made $\frac{1}{4}$ th of the diameter of the cylinder when of cast iron, and $\frac{1}{5}$ th when of wrought iron, which gives a load with low steam of about 500 lbs. per circular inch of transverse section; but a larger size is preferable, as with large bearings the brasses do not wear so rapidly and the straps are not so likely to be burst by the bearings becoming oval. These sizes, as also those which immediately follow, suppose the pressure on the piston to be 18 lbs. per circular inch.

348. Q.—How is the strength of a cast iron gudgeon computed?

A.—To find the proper size of a cast iron gudgeon adapted to sustain any given weight:—multiply the weight in lbs. by the intended length of bearing expressed in terms of the diameter; divide the product by 500, and extract the square root of the quotient, which is the diameter in inches.

349. Q.—What was Mr. Watt's rule for the strength of gudgeons?

A.—Supposing the gudgeon to be square, then, to ascertain the thickness, multiply the weight resting

on the gudgeon by the distance between the trunnions, and divide the product by 333. Extract the cube root of the quotient, which is the thickness in inches.

350. Q.—How do you find the proper strength for the cast iron beam of a land engine ?

A. — If the force acting at the end of an engine beam be taken at 18 lbs. per circular inch of the piston, then the force acting at the middle will be 36 lbs. per circular inch of the piston, and the proper strength of the beam at the centre will be found by the following rule:—divide the weight in lbs. acting at the centre by 250, and multiply the quotient by the distance between the extreme centres. To find the depth, the breadth being given:—divide this product by the breadth in inches, and extract the square root of the quotient, which is the depth. The depth of a land engine beam at the ends is usually made one-third of the depth at the centre (the depth at the centre being equal to the diameter of the cylinder in the case of low pressure engines), while the length is made equal to three times the length of the stroke, and the mean thickness $\frac{1}{8}$ th of the length—the width of the edge bead being about three times the thickness of the web. In many modern engines the force acting at the end of the beam is more than 18 lbs. per circular inch of the piston, and it is now known moreover that the strength of a beam depends mainly on the strength of the flanges.

351. Q.—What was Mr. Watt's rule for the main beams of his engines ?

A.—Some of those beams were of wood and some of cast iron. The wood beams were so proportioned

that the thickness was $\frac{1}{8}$ th of the circumference, and the depth $\frac{1}{75}$. The side of the beam, supposing it square, was found by multiplying the diameter of the cylinder by the length of the stroke, and extracting the cube root of the quotient, which will be the depth or thickness of the beam. This rule allows a beam 16 feet long to bend $\frac{1}{4}$ th of an inch, and a beam 32 feet long to bend $\frac{1}{4}$ of an inch. For cast iron beams the square of the diameter of the cylinder, multiplied by half the length between the centres, is equal to the square of the depth, multiplied by the thickness.

352. Q.—What law does the strength of beams and shafts follow?

A.—In the case of beams subjected to a breaking force, the strength with any given cohesion of the material will be proportional to the breadth, multiplied by the square of the depth; and in the case of revolving shafts exposed to a twisting strain, the strength with any given cohesive power of the material will be as the cube of the diameter.

353. Q.—How is the strength of a cast iron shaft to resist torsion determined?

A.—Experiments upon the force requisite to twist off cast iron necks show that if the cube of the diameter of neck in inches be multiplied by 880, the product will be the force of torsion which will twist them off when acting at 6 inches radius; on this fact the following rule is founded: To find the diameter of a cast iron fly wheel shaft:—multiply the square of the diameter of the cylinder in inches, by the length of the crank in inches, and extract the cube root of the product, which multiply by 0.3025, and the result

will be the proper diameter of the shaft in inches at the smallest part, when of cast iron.

354. Q.—What was Mr. Watt's rule for the necks of his crank shafts?

A.—Taking the pressure on the piston at 12 lbs. pressure on the square inch, and supposing this force to be applied at one foot radius, divide the total pressure of the piston reduced to 1 foot of radius by 31·4, and extract the cube root of the quotient, which is the diameter of the shaft: or extract the cube root of 13·7 times the number of cubic feet of steam required to make one revolution, which is also the diameter of the shaft.

355. Q.—Can you give any rule for the strength of the teeth of wheels?

A.—To find the proper dimensions for the teeth of a cast iron wheel:—multiply the diameter of the pitch circle in feet by the number of revolutions to be made per minute, and reserve the product for a divisor; multiply the number of *actual* horses power to be transmitted by 240, and divide the product by the above divisor, which will give the strength. If the pitch be given to find the breadth, divide the above strength by the square of the pitch in inches; or if the breadth be given, then to find the pitch divide the strength by the breadth in inches, and extract the square root of the quotient, which is the proper pitch in inches. The length of the teeth is usually about $\frac{1}{4}$ ths of the pitch. Pinions to work satisfactorily should not have less than 30 or 40 teeth, and where the speed exceeds 220 feet in the minute, the teeth of

the larger wheel should be of wood, made a little thicker to keep the strength unimpaired.

356. Q. — What was Mr. Watt's rule for the pitch of wheels?

A. — Multiply five times the diameter of the larger wheel by the diameter of the smaller, and extract the fourth root of the product, which is the pitch.

STRENGTH OF MARINE AND LOCOMOTIVE ENGINES.

357. Q. — Cannot you give some rules of strength which will be applicable whatever pressure may be employed?

A. — In the rules already given, the effective pressure may be reckoned at from 12 to 23 lbs. upon every square inch of the piston, as is usual in land engines; and if the pressure upon every square inch of the piston be made twice greater, the dimensions must just be those proper for an engine of twice the area of piston. It will not be difficult, however, to introduce the pressure into the rules as an element of the computation, whereby the result will be applicable both to high and low pressure engines.

358. Q. — Will you apply this mode of computation to a marine engine, and first find the diameter of the piston rod?

A. — The diameter of the piston rod may be found by multiplying the diameter of the cylinder in inches, by the square root of the pressure on the piston in lbs. per square inch, and dividing by 50, which makes the strain $\frac{1}{4}$ th of the elastic force.

359. Q.—What will be the rule for the connecting rod, supposing it to be of malleable iron?

A.—The diameter of the connecting rod at the ends, may be found by multiplying 0·019 times the square root of the pressure on the piston in lbs. per square inch by the diameter of the cylinder in inches; and the diameter of the connecting rod in the middle may be found by the following rule:—to 0·0035 times the length of the connecting rod in inches, add 1, and multiply the sum by 0·019 times the square root of the pressure on the piston in lbs. per square inch, multiplied by the diameter of the cylinder in inches. The strain is equal to $\frac{1}{4}$ th of the elastic force.

360. Q.—How will you find the diameter of the cylinder side rods of a marine engine?

A.—The diameter of the cylinder side rods at the ends may be found by multiplying 0·0129 times the square root of the pressure on the piston in lbs. per square inch by the diameter of the cylinder; and the diameter of the cylinder side rods at the middle is found by the following rule:—to 0·0035 times the length of the rod in inches, add 1, and multiply the sum by 0·0129 times the square root of the pressure on the piston in lbs. per square inch, multiplied by the diameter of the cylinder in inches; the product is the diameter of each side rod at the centre in inches. The strain upon the side rods is by these rules equal to $\frac{1}{4}$ th of the elastic force.

361. Q.—How do you determine the dimensions of the crank?

A.—To find the exterior diameter of the large eye of the crank when of malleable iron:—to 1·561 times

the pressure of the steam upon the piston in lbs. per square inch, multiplied by the square of the length of the crank in inches, add 0.00494 times the square of the diameter of the cylinder in inches, multiplied by the square of the number of lbs. pressure per square inch on the piston; extract the square root of this quantity; divide the result by 75.59 times the square root of the length of the crank in inches, and multiply the quotient by the diameter of the cylinder in inches; square the product and extract the cube root of the square, to which add the diameter of the hole for the reception of the shaft, and the result will be the exterior diameter of the large eye of the crank when of malleable iron. The diameter of the small eye of the crank may be found by adding to the diameter of the crank pin 0.02521 times the square root of the pressure on the piston in lbs. per square inch, multiplied by the diameter of the cylinder in inches.

362. Q.—What will be the thickness of the crank web?

A.—The thickness of the web of the crank, supposing it to be continued to the centre of the shaft, would at that point be represented by the following rule:—to 1.561 times the square of the length of the crank in inches, add 0.00494 times the square of the diameter of the cylinder in inches, multiplied by the pressure on the piston in lbs. per square inch; extract the square root of the sum, which multiply by the diameter of the cylinder squared in inches, and by the pressure on the piston in lbs. per square inch; divide the product by 9000, and extract the cube root of the quotient, which will be the proper thickness of the

web of the crank when of malleable iron, supposing the web to be continued to the centre of the shaft. The thickness of the web at the crank pin centre, supposing it to be continued thither, would be 0.022 times the square root of the pressure on the piston in lbs. per square inch, multiplied by the diameter of the cylinder. The breadth of the web of the crank at the shaft centre should be twice the thickness, and at the pin centre $1\frac{1}{2}$ times the thickness of the web; the length of the large eye of the crank should be equal to the diameter of the shaft, and of the small eye 0.0375 times the square root of the pressure on the piston in lbs. per square inch, multiplied by the diameter of the cylinder.

363. Q.—Will you apply the same method of computation to find the dimensions of a malleable iron paddle shaft?

A.—The method of computation will be as follows:—to find the dimensions of a malleable iron paddle shaft, so that the strain shall not exceed $\frac{5}{8}$ ths of the elastic force, or $\frac{4}{5}$ ths of the force iron is capable of withstanding without permanent derangement of structure, which in tensile strains is taken at 17,800 lbs. per square inch: multiply the pressure in lbs. per square inch on the piston by the square of the diameter of the cylinder in inches, and the length of the crank in inches, and extract the cube root of the product, which, multiplied by 0.08264, will be the diameter of the paddle shaft journal in inches when of malleable iron, whatever the pressure of the steam may be. The length of the paddle shaft journal should be $1\frac{1}{2}$ times the diameter; and the diameter

of the part where the crank is put on is often made equal to the diameter over the collars of the journal or bearing.

364. Q.—How do you find the diameter of the crank pin?

A.—The diameter of the crank pin in inches may be found by multiplying 0.02836 times the square root of the pressure on the piston in lbs. per square inch, by the diameter of the cylinder in inches. The length of the pin is usually about $\frac{2}{3}$ th times its diameter, and the strain if all thrown upon the end of the pin will be equal to the elastic force; but in ordinary working, the strain will only be equal to $\frac{1}{3}$ rd of the elastic force.

365. Q.—What are the dimensions of the cross head?

A.—If the length of the cross head be taken at 1.4 times the diameter of the cylinder, the dimensions of the cross head will be as follows:—the exterior diameter of the eye in the cross head for the reception of the piston rod, will be equal to the diameter of the hole, plus 0.02827 times the cube root of the pressure on the piston in lbs. per square inch, multiplied by the diameter of the cylinder in inches; and the depth of the eye will be 0.0979 times the cube root of the pressure on the piston in lbs. per square inch, multiplied by the diameter of the cylinder in inches. The diameter of each cross head journal will be 0.01716 times the square root of the pressure on the piston in lbs. per square inch, multiplied by the diameter of the cylinder in inches—the length of the journal being $\frac{2}{3}$ ths its diameter. The thickness of the web at centre

will be 0.0245 times the cube root of the pressure on the piston in lbs. per square inch, multiplied by the diameter of the cylinder in inches; and the depth of web at centre will be 0.09178 times the cube root of the pressure on the piston in lbs. per square inch, multiplied by the diameter of the cylinder in inches. The thickness of the web at journal will be 0.0122 times the square root of the pressure on the piston in lbs. per square inch, multiplied by the diameter of the cylinder in inches; and the depth of the web at journal will be 0.0203 times the square root of the pressure upon the piston in lbs. per square inch, multiplied by the diameter of the cylinder in inches. In these rules for the cross head, the strain upon the web is $\frac{1}{2.5}$ times the elastic force; the strain upon the journal in ordinary working is $\frac{1}{2.5}$ times the elastic force; and if the outer ends of the journals are the only bearing points, the strain is $\frac{1}{1.168}$ times the elastic force, which is very little in excess of the elastic force.

366. Q.—How do you find the diameter of the main centre when proportioned according to this rule?

A.—The diameter of the main centre may be found by multiplying 0.0367 times the square root of the pressure upon the piston in lbs. per square inch, by the diameter of the cylinder in inches, which will give the diameter of the main centre journal in inches when of malleable iron, and the length of the main centre journal should be $1\frac{1}{2}$ times its diameter; the strain upon the main centre journal in ordinary working will be about $\frac{1}{2}$ the elastic force.

367. Q.—What are the proper dimensions of the gibs and cutters of an engine?

A.—The depth of gibs and cutters for attaching the piston rod to the cross head, is 0.0358 times the cube root of the pressure of the steam on the piston in lbs. per square inch, multiplied by the diameter of the cylinder; and the thickness of the gibs and cutters is 0.007 times the cube root of the pressure on the piston in lbs. per square inch, multiplied by the diameter of the cylinder. The depth of the cutter through the piston is 0.017 times the square root of the pressure on the piston in lbs. per square inch, multiplied by the diameter of the cylinder in inches; and the thickness of the cutter through the piston is 0.007 times the square root of the pressure on the piston in lbs. per square inch, multiplied by the diameter of the cylinder.

368. Q.—Are not some of the parts of an engine constructed according to these rules too weak, when compared with the other parts?

A.—It is obvious, from the varying proportions subsisting in the different parts of the engine between the strain and the elastic force, that in engines proportioned by these rules — which represent nevertheless the average practice of the best constructors — some of the parts must possess a considerable excess of strength over other parts, and it appears expedient that this disparity should be diminished, which may best be done by increasing the strength of the parts which are weakest; inasmuch as the frequent fracture of some of the parts shows that the dimensions at

present adopted for those parts are scarcely sufficient, unless the iron of which they are made is of the best quality. At the same time it is quite certain, that engines proportioned by these rules will work satisfactorily where good materials are employed ; but it is important to know in what parts good materials and large dimensions are the most indispensable. In many of the parts, moreover, it is necessary that the dimensions should be proportioned to meet the wear and the tendency to heat, instead of being merely proportioned to obtain the necessary strength ; and the crank pin is one of the parts which requires to be large in diameter, and as long as possible in the bearing, so as to distribute the pressure, and prevent the disposition to heat which would otherwise exist. The cross head journals also should be long and large ; for as the tops of the side rods have little travel, the oil is less drawn into the bearings than if the travel was greater, and is being constantly pressed out by the punching strain. This strain should therefore be reduced as far as possible by its distribution over a large surface. In the rules which are contained in the answers to the ten preceding questions (358 to 367) the pressure on the piston in lbs. per square inch is taken as the sum of the pressure of steam in the boiler and of the vacuum ; the latter being assumed to be 15 lbs. per square inch.

CHAP. VII

CONSTRUCTIVE DETAILS OF BOILERS.

LAND AND MARINE BOILERS.

369. Q.—Will you explain the course of procedure in the construction and setting of waggon boilers?

A. — Most boilers are made of plates three-eighths of an inch thick, and the rivets are from three-eighths to three-fourths of an inch in diameter. In the bottom and sides of a waggon boiler the heads of the rivets, or the ends formed on the rivets before they are inserted, should be large and placed next the fire, or on the outside; whereas on the top of the boiler the heads should be on the inside. The rivets should be placed about two inches distant from centre to centre, and the centre of the row of rivets should be about one inch from the edge of the plate. The edges of the plates should be truly cut, both inside and outside, and after the parts of the boiler have been riveted together, the edges of the plates should be set up or caulked with a blunt chisel about a quarter of an inch thick in the point, and struck by a hammer of about three or four pounds weight, one man holding the caulking tool while another strikes.

370. *Q.* — Is this the usual mode of caulking ?

A. — No, it is not the usual mode; but it is the best mode, and is the mode adopted by Mr. Watt. The usual mode now is for one man to caulk the seams with a hammer in one hand and a caulking chisel in the other, and in some of the difficult corners of marine flue boilers it is not easy for two men to get in. A good deal of the caulking has also sometimes to be done with the left hand.

371. *Q.* — Should the boiler be proved after caulking ?

A. — The boiler should be filled with water and caulked afresh in any leaky part when emptied again. All the joints should be painted with a solution of sal ammoniac in urine, and so soon as the seams are well rusted they should be dried with a gentle fire, and then be painted over with a thin putty formed of whiting and linseed oil, the heat being continued until the putty becomes so hard that it cannot be readily scratched with the nail, and care must be taken neither to burn the putty nor to discontinue the fire until it has become quite dry.

372. *Q.* — How should the brickwork setting of a waggon boiler be built ?

A. — In building the brickwork for the setting of the boiler, the parts upon which the heat acts with most intensity is to be built with clay instead of mortar, but mortar is to be used on the outside of the work. Old bars of flat iron may be laid under the boiler chime to prevent that part of the boiler from being burned out, and bars of iron should also run through the brickwork to prevent it from splitting.

The top of the boiler is to be covered with brickwork laid in the best lime, and if the lime be not of the hydraulic kind it should be mixed with Dutch terrass to make it impenetrable to water. The top of the boiler should be well plastered with this lime, which will greatly conduce to the tightness of the seams. Openings into the flues must be left in convenient situations to enable the flues to be swept out when required, and these openings may be closed with cast iron doors jointed with clay or mortar, which may be easily removed when required. Adjacent to the chimney a slit must be left in the top of the flue with a groove in the brickwork to enable the sliding door or damper to be fixed in that situation, which by being lowered into the flue will obstruct the passage of the smoke and moderate the draught, whereby the chimney will be prevented from drawing the flame into it before the heat has acted sufficiently upon the boiler.

373. Q. — Are marine constructed in the same way as land boilers ?

A. — There is very little difference in the two cases : the whole of the shells of marine boilers, however, should be double riveted with rivets $\frac{1}{8}$ ths of an inch in diameter, and $2\frac{3}{8}$ th inches from centre to centre, the weakening effect of double riveting being much less than that of single riveting. The furnaces above the line of bars should be of the best Lowmoor, Bowling, or Staffordshire scrap plates, and the portion of each furnace above the bars should consist only of three plates, one for the top and one for each side, the lower seam of the side plates being situated beneath

the level of the bars, so as not to be exposed to the heat of the furnace. The tube plates of tubular boilers should be of the best Lowmoor, or Bowling iron, seven-eighths to one inch thick: the shells should be of the best Staffordshire, or Thornycroft S crown iron, $\frac{7}{8}$ ths of an inch thick.

374. Q. — Of what kind of iron should the angle iron or corner iron be composed?

A. — Angle iron should not be used in the construction of boilers, as in the manufacture it becomes reedy, and is apt to split up in the direction of its length: it is much the safer practice to bend the plates at the corners of the boiler; but this must be carefully done without introducing any more sharp bends than can be avoided, and plates which require to be bent much should be of Lowmoor iron. It will usually be found expedient to introduce a ring of angle iron around the furnace mouths, though it is discarded in the other parts of the boiler; but it should be used as sparingly as possible, and any that is used should be of the best quality.

375. Q. — Is it not important to have the holes in the plates opposite to one another?

A. — The whole of the plates of a boiler should have the holes for the rivets punched, and the edges cut straight, by means of self-acting machinery, in which a travelling table carries forward the plate with an equal progression every stroke of the punch or shears; and machinery of this kind is now extensively employed. The practice of forcing the parts of boilers together with violence, by means of screw-jacks, and drifts through the holes, should not be permitted; as

a great strain may thus be thrown upon the rivets, even when there is no steam in the boiler. All rivets should be of the best Lowmoor iron. The work should be caulked both within and without wherever it is accessible, but in the more confined situations within the flues the caulking will in many cases have to be done with the hand or chipping hammer instead of the heavy hammer previously prescribed.

376. *Q.* — How is the setting of marine boilers with internal furnaces effected?

A. — In the setting of marine boilers care must be taken that no copper bolts or nails project above the wooden platform upon which they rest, and also that no projecting copper bolts in the sides of the ship touch the boiler, as the galvanic action in such a case would probably soon wear the points of contact into holes. The platform may consist of three inch planking laid across the keelsons nailed with iron nails, the heads of which are well punched down, and caulked and puttied like a deck. The surface may then be painted over with thin putty, and fore and aft boards of half the thickness may then be laid down and nailed securely with iron nails, having the heads well punched down. This platform must then be covered thinly and evenly with mastic cement and the boiler be set down upon it, and the cement must be caulked beneath the boiler by means of wooden caulking tools, so as completely to fill every vacuity. Coomings of wood sloped on the top must next be set round the boiler, and the space between the coomings and the boiler must be caulked full of cement, and be smoothed off on the top to the slope of the coomings, so as to

throw off any water that might be disposed to enter between the coomings and the boiler.

377. Q. — How is the cement used for setting marine boilers compounded?

A. — Mastic cement proper for the setting of boilers is sold in many places ready made. Hamelin's mastic is compounded as follows: — to any given weight of sand or pulverised earthenware add two-thirds such given weight of powdered Bath, Portland, or other similar stone, and to every 560 lbs. weight of the mixture add 40 lbs. weight of litharge, 2 lbs. of powdered glass or flint, 1 lb. of minium, and 2 lbs. of gray oxide of lead; pass the mixture through a sieve, and keep it in a powder for use. When wanted for use, a sufficient quantity of the powder is mixed with some vegetable oil upon a board or in a trough in the manner of mortar, in the proportion of 605 lbs. of the powder to 5 gallons of linseed, walnut, or pink oil, and the mixture is stirred and trodden upon until it assumes the appearance of moistened sand, when it is ready for use. The cement should be used on the same day as the oil is added, else it will set into a solid mass.

378. Q. — What is the best length of the furnaces of marine boilers?

A. — It has already been stated that furnace bars should not much exceed six feet in length, as it is difficult to manage long furnaces; but it is a frequent practice to make the furnaces long and narrow, the consequence of which is, that it is impossible to fire them effectually at the after end, especially upon long voyages and in stormy weather, and air escapes into

the flues at the after end of the bars, whereby the efficacy of the boiler is diminished. Where the bars are very long it will generally be found that an increased supply of steam and a diminished consumption of coal will be the consequence of shortening them, and the bars should always lie with a considerable inclination to facilitate the distribution of the fuel over the after part of the furnace. When there are two lengths of bars in the furnace, it is expedient to make the central cross bar for bearing up the ends double, and to leave a space between the ends of the bars so that the ashes may fall through between them. The space thus left enables the bars to expand without injury on the application of heat, whereas without some such provision the bars are very liable to get burned out by bending up in the centre, or at the ends, as they must do if the elongation of the bars on the application of heat be prevented; and this must be the effect of permitting the spaces at the ends of the bars to be filled up with ashes. At each end of each bed of bars it is expedient to leave a space which the ashes cannot fill up so as to cause the bars to jam; and care must be taken that the heels of the bars do not come against any of the furnace bearers, whereby the room left at the end of the bars to permit the expansion would be rendered of no avail.

379. Q.—Have you any remarks to offer respecting the construction and arrangement of the furnace bridges and dampers of marine boilers?

A.—The furnace bridges of marine boilers are walls or partitions built up at the ends of the furnaces to narrow the opening for the escape of heat into the

flues. They are either made of fire brick or of plate iron containing water: in the case of water bridges, the top part of the bridge should be made with a large amount of slant so as to enable the steam to escape freely, but notwithstanding this precaution the plates of water bridges are apt to crack at the bend, so that fire brick bridges appear on the whole to be preferable. In shallow furnaces the bridges often come too near the furnace top to enable a man to pass over them; and it will save expense if in such bridges the upper portion is constructed of two or three fire blocks, which may be lifted off where a person requires to enter the flues to sweep or repair them, whereby the perpetual demolition and reconstruction of the upper part of the bridge will be prevented.

380. Q.—What is the benefit of bridges?

A.—Bridges are found in practice to have a very sensible operation in increasing the production of steam, and in some boilers in which the brick bridges have been accidentally knocked down by the firemen, a very considerable diminution in the supply of steam has been experienced. Their chief operation seems to lie in concentrating the heat within the furnace to a higher temperature, whereby the heat is more rapidly transmitted from the furnace to the water, and less heat has consequently to be absorbed by the flues. In this way the bridges render the heating surface of a boiler more effective, or enable a smaller amount of heating surface to suffice.

381. Q.—Are the bridges behind the furnaces the only bridges used in steam boilers?

A.—It is not an uncommon practice to place a

hanging bridge, consisting of a plate of iron descending a certain distance into the flue, at that part of the flue where it enters the chimney, whereby the stratum of hot air which occupies the highest part of the flue is kept in protracted contact with the boiler, and the cooler air occupying the lower part of the flue is that which alone escapes. The practice of introducing a hanging bridge is a beneficial one in the case of some boilers, but is not applicable universally, as boilers with a small calorimeter cannot be further contracted in the flue without a diminution in their evaporating power. In tubular boilers a hanging bridge is not applicable, but in some cases a perforated plate is placed against the ends of the tubes, which by suitable connections is made to operate as a sliding damper which partially or totally closes up the end of every tube, and at other times a damper constructed in the manner of a venetian blind is employed in the same situation. These varieties of damper, however, have only yet been used in locomotive boilers, though applicable to tubular boilers of every description.

382. Q.—Is it a benefit to keep the flues or tubes appertaining to each furnace distinct?

A.—In a flue boiler this cannot be done, but in a tubular boiler it is an advantage that there should be a division between the tubes pertaining to each furnace, so that the smoke of each furnace may be kept apart from the smoke of the furnace adjoining it until the smoke of both enters the chimney, as by this arrangement a furnace only will be rendered inoperative in cleaning the fires instead of a boiler, and the tubes belonging to one furnace may be swept if necessary at

sea without interfering injuriously with the action of the rest. In a steam vessel it is necessary at intervals to empty out one or more furnaces every watch to get rid of the clinkers which would otherwise accumulate in them; and it is advisable that the connection between the furnaces should be such that this operation, when being performed on one furnace, shall injure the action of the rest as little as possible.

383. Q. — Can any constructive precautions be taken to prevent the furnaces and tube plates of the boiler from being burned by the intensity of the heat?

A. — The sides of the internal furnaces or flues in all boilers should be so constructed that the steam may readily escape from their surfaces, with which view it is expedient to make the bottom of the flue somewhat wider than the top, or slightly conical in the cross section; and the upper plates should always be overlapped by the plates beneath, so that the steam cannot be retained in the overlap, but will escape as soon as it is generated. If the sides of the furnace be made high and perfectly vertical, they will speedily be buckled and cracked by the heat, as a film of steam in such a case will remain in contact with the iron which will prevent the access of the water, and the iron of the boiler will be injured by the high temperature it must in that case acquire. To moderate the intensity of the heat acting upon the furnace sides, it is expedient to bring the outside fire bars into close contact with the sides of the furnace, so as to prevent the entrance of air through the fire in that situation, by which the intensity of the heat would be increased.

The tube plate nearest the furnace in tubular boilers should also be so inclined as to facilitate the escape of the steam; and the short bent plate or flange of the tube plate, connecting the tube plate with the top of the furnace, should be made with a gradual bend, as, if the bend be sudden, the iron will be apt to crack or burn away from the concretion of salt. Where the furnace mouths are contracted by bending in the sides and top of the furnace, as is the general practice, the bends should be gradual, as salt is apt to accumulate in the pockets made by a sudden bend, and the plates will then burn into holes.

384. Q.—In what manner is the tubing of boilers performed?

A.—The tubes of marine boilers are generally iron tubes, three inches in diameter, and between six and seven feet long; but sometimes brass tubes of similar dimensions are employed. When brass tubes are employed the use of ferules driven into the ends of the tubes is sometimes employed to keep them tight; but when the tubes are of malleable iron, of the thickness of Russell's boiler tubes, they may be made tight merely by driving them firmly into the tube plates, and the same may be done with thick brass tubes. The holes in the tube plate next the front of the boiler are just sensibly larger in diameter than the holes in the other tube plate, and the holes upon the outer surfaces of both tube plates are very slightly countersunk. The whole of the tubes are driven through both tube plates from the front of the boiler,—the precaution, however, being taken to drive them in gently at first with a light hand hammer, until the whole of the

tubes have been inserted to an equal depth, and then they may be driven up by degrees with a heavy hammer, whereby any distortion of the holes from unequal driving will be prevented. Finally, the ends of the tubes should be riveted up so as to fill the countersink; the tubes should be left a little longer than the distance between the outer surfaces of the tube plates, so that the countersink at the ends may be filled by staving up the end of the tube rather than by riveting it over; and the staving will be best accomplished by means of a mandril with a collar upon it, which is driven into the tube so that the collar rests upon the end of the tube to be riveted; or a tool like a blunt chisel with a recess in its point may be used, as is the more usual practice.

385. *Q.* — Should not stays be introduced in substitution of some of the tubes?

A. — It appears expedient in all cases that some of the tubes should be screwed at the ends, so as to serve as stays if the riveting at the tube ends happens to be burned away, and also to act as abutments to the riveted tube—or else to introduce very strong rods of about the same diameter as a tube, in substitution of some of the tubes; and these stays should have nuts at each end both within and without the tube plates, which nuts should be screwed up, with white lead interposed, before the tubes are inserted. If the tubes are long, their expansion when the boiler is being blown off will be apt to start them at the ends, unless very securely fixed; and it is difficult to prevent brass tubes of large diameter and proportionate length from being started at the ends, even when secured by

ferules; but the brass tubes commonly employed are so small as to be susceptible of sufficient compression endways by the adhesion due to the ferules to compensate for the expansion, whereby they are prevented from starting at the ends. In some of the early marine boilers fitted with brass tubes, a galvanic action at the ends of the tubes was found to take place, and the iron of the tube plates was wasted away in consequence, with rapidity; but further experience proved the injury to be attributable chiefly to imperfect fitting, whereby a leakage was caused that induced oxidation, and when the tubes were well fitted any injurious action at the ends of the tubes was found to cease.

386. Q.—What is the best mode of constructing the chimney and the parts in connection therewith?

A.—In sea-going steamers the funnel plates are usually about nine feet long and $\frac{3}{16}$ ths thick; and where different flues or boilers have their debouch in the same chimney, it is expedient to run division plates up the chimney for a considerable distance, to keep the draughts distinct. The dampers should not be in the chimney but at the end of the boiler flue, so that they may be available for use if the funnel by accident be carried away. The waste steam pipe should be of the same height as the funnel so as to carry the waste steam clear of it, for if the waste steam strikes the funnel it will wear the iron into holes; and the waste steam pipe should be made at the bottom with a faucett joint, to prevent the working of the funnel, when the vessel rolls, from breaking the pipe at the neck. There should be two hoops round

the funnel, for the attachment of the funnel shrouds, instead of one, so that the funnel may not be carried overboard if one hoop breaks, or if the funnel breaks at the upper hoop from the corrosive action of the waste steam, as sometimes happens. The deck over the steam chest should be formed of an iron plate supported by angle iron beams, and there should be a high angle iron coaming round the hole in the deck through which the chimney ascends, to prevent any water upon the deck from leaking down upon the boiler. Around the lower part of the funnel there should be a sheet iron casing to prevent any inconvenient dispersion of heat in that situation, and another short piece of casing, of a somewhat larger diameter and riveted to the chimney, should descend over the first casing, so as to prevent the rain or spray which may beat against the chimney from being poured down within the casing upon the top of the boiler. The pipe for conducting away the waste water from the top of the safety valve should lead overboard, and not into the bilge of the ship, as inconvenience arises from the steam occasionally passing through it, if it has its termination in the engine room.

387. Q.—Are not the chimnies of some vessels made so that they may be lowered when required ?

A.—The chimnies of small river vessels which have to pass under bridges are generally formed with a hinge so that they may be lowered backwards when passing under a bridge, and the chimnies of some screw vessels are made so as to shut up like a spy-glass when the fires are put out and the vessel is

navigated under sails. A very good example of this species of chimney is that designed by Mr. Taplin and represented in *fig. 34*. In smaller vessels, how-

Fig. 34.

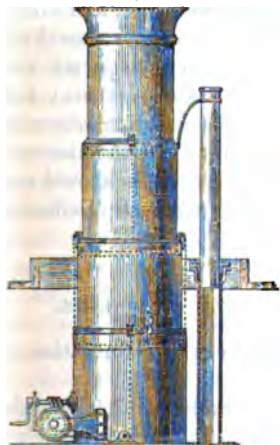

TELESCOPE CHIMNEY.

ever, two lengths of chimney suffice; and in that case there is a standing piece on deck, which, however, does not project above the bulwarks.

388. Q.—Will you explain any further details in the construction of marine boilers which occur to you as important?

A.—The man-hole and mud-hole doors, unless put on from the outside like a cylinder cover with a great number of bolts, should be put on from the inside with cross bars on the outside, and the bolts should

be strong, and have coarse threads and square nuts so that the threads may not be overrun, nor the nuts become round, by the unskilful manipulations of the firemen, by whom these doors are removed or replaced. It is very expedient that sufficient space should be left between the furnace and the tubes in all tubular boilers to permit a boy to go in to clear away any scale that may have formed, and to hold on the rivets in the event of repair being wanted; and it is also expedient that a vertical row of tubes should

be left out opposite to each water space to allow the ascent of the steam and the descent of the water, as it has been found that the removal of the tubes in that position, even in a boiler with deficient heating surface, has increased the production of steam, and diminished the consumption of fuel. The tubes should all be kept in the same vertical line, so as to permit the introduction of an instrument to scrape them; but they may be zig-zagged in the horizontal line, whereby a greater strength of metal will be obtained around the holes in the tube plates, and the tubes should not be placed too close together, else their heating efficacy will be impaired.

INCRUSTATION AND CORROSION OF BOILERS.

389. **Q.**—What is the cause of the formation of scale in marine boilers?

A.—Scale is formed in all boilers which contain earthy or saline matters, just in the way in which a scaly deposit, or rock as it is sometimes termed, is formed in a tea kettle. In sea water the chief ingredient is common salt, which exists in solution: the water admitted to the boiler is taken away in the shape of steam, and the saline matter which is not vapourisable accumulates in process of time in the boiler, until its amount is so great that the water is saturated, or unable to hold any more in solution; the salt is then precipitated and forms a deposit which hardens by heat. The formation of scale, therefore, is similar to the process of making salt from sea water by evaporation, the boiler being, in fact, a large salt pan.

390. Q.—But is the scale soluble in fresh water like the salt in a salt pan?

A.—No, it is not; or if soluble at all, is only so to a very limited extent. The several ingredients in sea water begin to be precipitated from solution at different degrees of concentration; and the sulphate and carbonate of lime, which begin to be precipitated when a certain state of concentration is reached, enter largely into the composition of scale, and give it its insoluble character. Pieces of waste or other similar objects left within a marine boiler appear, when taken out, as if they had been petrified; and the scale deposited upon the flues of a marine boiler resembles layers of stone.

391. Q.—Is much inconvenience experienced in marine boilers from these incrustations upon the flues?

A.—Incrustation in boilers at one time caused much more perplexity than it does at present, as it was supposed that in some seas it was impossible to prevent the boilers of a steamer from becoming salted up; but it has now been satisfactorily ascertained that there is very little difference in the saltness of different seas, and that however salt the water may be, the boiler will be preserved from any injurious amount of incrustation by blowing off, as it is called, very frequently, or by permitting a considerable portion of the supersalted water to escape at short intervals into the sea. If blowing off be sufficiently practised, the scale upon the flues will never be much thicker than a sheet of writing paper, and *no excuse* should be accepted from engineers for permitting a

boiler to be damaged by the accumulation of calcareous deposit.

392. Q.—What is the temperature at which sea water boils in a steam boiler?

A.—Sea water contains about $\frac{1}{33}$ rd its weight of salt, and in the open air it boils at the temperature of 213.2° ; if the proportion of salt be increased to $\frac{2}{33}$ rds of the weight of the water, the boiling point will rise to 214.4° ; with $\frac{3}{33}$ rds of salt the boiling point will be 215.5° ; $\frac{4}{33}$ rds, 216.7° ; $\frac{5}{33}$ rds, 217.9° ; $\frac{6}{33}$ rds, 219° ; $\frac{7}{33}$ rds, 220.2° ; $\frac{8}{33}$ rds, 221.4° ; $\frac{9}{33}$ rds, 222.5° ; $\frac{10}{33}$ rds, 223.7° ; $\frac{11}{33}$ rds, 224.9° ; and $\frac{12}{33}$ rds, which is the point of saturation, 226° . In a steam boiler the boiling points of water containing these proportions of salt must be higher, as the elevation of temperature due to the pressure of the steam has to be added to that due to the saltiness of the water: the temperature of steam at the atmospheric pressure being 212° , its temperature, at a pressure of 15 lbs. per square inch above the atmosphere, will be 250° , and adding to this 4.7° as the increased temperature due to the saltiness of the water when it contains $\frac{1}{33}$ rds of salt, we have 254.7° as the temperature of the water in the boiler, when it contains $\frac{1}{33}$ rds of salt and the pressure of the steam is 15 lbs. on the square inch.

393. Q.—What degree of concentration of the salt water may be safely permitted in a boiler?

A.—It is found by experience that when the concentration of the salt water in a boiler is prevented from exceeding that point at which it contains $\frac{2}{33}$ rds its weight of salt, no injurious incrustation will take place, and as sea water contains only $\frac{1}{33}$ rd of its

weight of salt, it is clear that it must be reduced by evaporation to one-half of its bulk before it can contain $\frac{2}{3}$ rds of salt; or, in other words, a boiler must blow out into the sea one-half of the water it receives as feed, in order to prevent the water from rising above $\frac{2}{3}$ rds of concentration, or 8 ounces of salt to the gallon.

394. Q. — How do you determine 8 ounces to the gallon to be equivalent to twice the density of salt water, or "two salt waters" as it is sometimes called?

A. — The density of the water of different seas varies somewhat. A gallon of fresh water weighs 10 lbs.; a gallon of salt water from the Baltic weighs 10.15 lbs.; a gallon of salt water from the Irish Channel weighs 10.28 lbs.; and a gallon of salt water from the Mediterranean 10.29 lbs. If we take an average saltness represented by a weight of 10.25 lbs., then a gallon of water concentrated to twice this saltness will weigh 10.5 lbs., or the salt in it will weigh .5 lbs. or 8 oz., which is the proportion of 8 oz. to the gallon. However, the proportion of $\frac{2}{3}$ rds gives a greater proportion than 8 oz. to the gallon, for $\frac{2}{3} = \frac{1}{1.5}$ nearly, and $\frac{1}{1.5}$ of 10 lbs. = 10 oz. By keeping the density of the water in a marine boiler at the proportion of 8 or 10 oz. to the gallon, no inconvenient amount of scale will be deposited on the flues or tubes. The bulk of water, it may be remarked, is not increased by putting salt in it up to the point of saturation, but only its density is increased.

395. Q. — Is there not a great loss of heat by blow-

ing off so large a proportion of the heated water from the boiler?

A.—The loss is not very great. Boilers are sometimes worked at a saltness of $\frac{4}{3}$ rds, and taking this saltness and supposing the latent heat of steam to be at 1000° at the temperature of 212° , and reckoning the sum of the latent and sensible heats as forming a constant quantity, the latent heat of steam at the temperature of 250° will be 962° , and the total heat of the steam will be 1212° in the case of fresh water; but as the feed water is sent into the boiler at the temperature of 100° , the accession of heat it receives from the fuel will be 1112° in the case of fresh water, or 1112° increased by $2\cdot23^{\circ}$ in the case of water containing $\frac{4}{3}$ rds of salt— $2\cdot23^{\circ}$ being the $4\cdot70^{\circ}$ increase of temperature due to the presence of $\frac{4}{3}$ rds of salt, multiplied by $0\cdot475$, the specific heat of steam. This makes the total accession of heat received by the steam in the boiler equal to $1114\cdot23^{\circ}$, or say 1114° , which multiplied by 3, as 3 parts of the water are raised into steam, gives us 3342° for the heat in the steam, while the accession of heat received in the boiler by the 1 part of residual brine will be $154\cdot7^{\circ}$, multiplied by $0\cdot85$, the specific heat of the brine, or $130\cdot495^{\circ}$; and 3342° divided by $130\cdot495^{\circ}$ is about $\frac{1}{8}$ th. It appears, therefore, that by blowing off the boiler to such an extent that the saltness shall not rise above what answers to $\frac{4}{3}$ rds of salt, about $\frac{1}{8}$ th of the heat is blown into the sea: this is but a small proportion; and as there will be a greater waste of heat, if from the existence of scale upon the flues the heat can be only imperfectly transmitted to the water,

there cannot be even an economy of fuel in niggard blowing off, while it involves the introduction of other evils. The proportion of $\frac{4}{3}$ rds of saltness, however, or 16 oz. to the gallon, is larger than is advisable, especially as it is difficult to keep the saltness at a perfectly uniform point, and the working point should, therefore, be $\frac{2}{3}$ rds as before prescribed.

396. Q.—Have no means been devised for turning to account the heat contained in the brine which is expelled from the boiler?

A.—To save a part of the heat lost by the operation of blowing off, the hot brine is sometimes passed through a number of small tubes surrounded by the feed water; but there is no very great gain from the use of such apparatus, and the tubes are apt to become choked up, whereby the safety of the boiler may be endangered by the injurious concentration of its contents. Pumps, worked by the engine for the extraction of the brine, are generally used in connection with the small tubes for the extraction of the heat from the supersalted water; and if the tubes become choked the pumps will cease to eject the water, while the engineer may consider them to be all the while in operation.

397. Q.—What is the usual mode of blowing off the supersalted water from the boiler?

A.—The general mode of blowing off the boiler is to allow the water to rise gradually for an hour or two above the lowest working level, and then to open the cock communicating with the sea, and keep it open until the surface of the water within the boiler has fallen several inches; but in some cases a cock of

smaller size is allowed to run water continuously, and in other cases brine pumps are used as already mentioned. In every case in which the supersalted water is discharged from the boiler in a continuous stream, a hydrometer or salt gauge of some convenient construction should be applied to the boiler, so that the density of the water may at all times be visible, and immediate notice be given of any interruption of the operation. Various contrivances have been devised for this purpose, the most of which operate on the principle of a hydrometer; but perhaps a more satisfactory principle would be that of a differential steam gauge, which would indicate the difference of pressure between the steam in the boiler and the steam of a small quantity of fresh water enclosed in a suitable vessel, and immersed in the water of the boiler.

398. Q.—What is the advantage of blowing off from the surface of the water in the boiler?

A.—Blowing off from a point near the surface of the water is more beneficial than blowing off from the bottom of the boiler. Solid particles of any kind, it is well known, if introduced into boiling water, will lower the boiling point in a slight degree, and the steam will chiefly be generated on the surface of the particles, and indeed will have the appearance of coming out of them: if the particles be small the steam generated beneath and around them will balloon them to the surface of the water, where the steam will be liberated and the particles will descend; and the impalpable particles in a marine boiler, which by their subsidence upon the flues concrete

into scale, are carried in the first instance to the surface of the water, so that if they be caught there and ejected from the boiler the formation of scale will be prevented.

399. Q.— Are there any plans in operation for taking advantage of this property of particles rising to the surface?

A.— Advantage is taken of this property in Lamb's Scale Preventer, which is substantially a contrivance for blowing off from the surface of the water that in practice is found to be very effectual; but a float in connection with a valve at the mouth of the discharging pipe is there introduced, so as to regulate the quantity of water blown out by the height of the water level, or by the extent of opening given to the feed cock. The operation, however, of the contrivance would be much the same if the float were dispensed with; but the float acts advantageously in hindering the water from rising too high in the boiler, should too much feed be admitted, and thereby obviates the risk of the water running over into the cylinder. In some boilers sheet iron vessels, called sediment collectors, are employed, which collect into them the impalpable matter, which in Lamb's apparatus is ejected from the boiler at once. One of these vessels, of about the size and shape of a loaf of sugar, is put into each boiler with the apex of the cone turned downwards into a pipe leading overboard, for conducting the sediment away from the boiler. The base of the cone stands some distance above the water line, and in its sides conical slits are cut, so as to establish a free communication between the water within the

conical vessel and the water outside it. The particles of stony matter which are ballooned to the surface by the steam in every other part of the boiler, subside within the cone, where, no steam being generated, the water is consequently tranquil; and the deposit is discharged overboard by means of a pipe communicating with the sea. By blowing off from the surface of the water, the requisite cleansing action is obtained with less waste of heat; and where the water is muddy, the foam upon the surface of the water is ejected from the boiler—thereby removing one of the chief causes of priming.

400. Q.—What is the cause of the rapid corrosion of marine boilers?

A.—Marine boilers are corroded externally in the region of the steam chest by the dripping of water from the deck; the bottom of the boiler is corroded by the action of the bilge water, and the ash pits by the practice of quenching the ashes with salt water. These sources of injury, however, admit of easy remedy: the top of the boiler may be preserved from external corrosion by covering it with felt upon which is laid sheet lead soldered at every joint so as to be impenetrable to water; the ash pits may be shielded by guard plates which are plates fitting into the ash pits and attached to the boiler by a few bolts, so that when worn they may be removed and new ones substituted, whereby any wear upon the boiler in that part will be prevented; and there will be very little wear upon the bottom of a boiler if it be imbedded in mastic cement laid upon a suitable platform.

401. Q. — Are not marine boilers subject to internal corrosion?

A. — Yes; the greatest part of the corrosion of a boiler takes place in the inside of the steam chest, and the origin of this corrosion is one of the obscurest subjects in the whole range of engineering. It cannot be from the chemical action of the salt water upon the iron, for the flues and other parts of the boiler beneath the water suffer very little from corrosion, and in steam vessels provided with Hall's condensers, which supply the boiler with fresh water, not much increased durability of the boiler has been experienced. Nevertheless, marine boilers seldom last more than for 5 or 6 years, whereas land boilers made of the same quality of iron often last 18 or 20 years, and it does not appear probable that land boilers would last a very much shorter time if salt water were used in them. The thin film of scale spread over the parts of a marine boiler situated beneath the water, effectually protect them from corrosion; and when the other parts are completely worn out the flues generally remain so perfect, that the hammer marks upon them are as conspicuous as at their first formation. The operation of the steam in corroding the interior of the boiler is most capricious — the parts which are most rapidly worn away in one boiler being untouched in another; and in some cases one side of a steam chest will be very much wasted away while the opposite side remains uninjured. Sometimes the iron exfoliates in the shape of a black oxide which comes away in flakes like the leaves of a book, while in other cases the iron appears as if eaten away by a

strong acid which had a solvent action upon it. The application of felt to the outside of a boiler, has in several cases been found to accelerate sensibly its internal corrosion; boilers in which there is a large accumulation of scale appear to be more corroded than where there is no such deposit; and where the funnel passes through the steam chest the iron of the steam chest is invariably much more corroded than where the funnel does not pass through it.

402. Q.—Can you suggest no reason for the rapid internal corrosion of marine boilers?

A.—The facts which I have enumerated appear to indicate that the internal corrosion of marine boilers is attributable chiefly to the existence of surcharged steam within them, which is steam to which an additional quantity of heat has been communicated subsequently to its generation, so that its temperature is greater than is due to its elastic force; and on this hypothesis the observed facts relative to corrosion become to some extent explicable. Felt, applied to the outside of a boiler, may accelerate its internal corrosion by keeping the steam in a surcharged state, when by the dispersion of a part of the heat it would cease to be in that state; boilers in which there is a large accumulation of scale must have worked with the water very salt, which necessarily produces surcharged steam; for the temperature of steam cannot be less than that of the water from which it is generated, and inasmuch as the boiling point of water, under any given pressure, rises with the saltiness of the water, the temperature of the steam must rise with the saltiness of the water, the pressure remaining the

same ; or, in other words, the steam must have a higher temperature than is due to its elastic force, or be in the state of surcharged steam. The circumstance of the chimney flue passing through the steam will manifestly surcharge the steam with heat, so that all the circumstances which are found to accelerate corrosion, are it appears such as would also induce the formation of surcharged steam.

403. Q. — Is it the natural effect of surcharged steam to waste away iron ?

A. — It is the natural effect of surcharged steam to oxidate the iron with which it is in contact, as is illustrated by the familiar process for making hydrogen gas by sending steam through a red hot tube filled with pieces of iron ; and although the action of the surcharged steam in a boiler is necessarily very much weaker than where the iron is red hot, it manifestly must have *some* oxidising effect, and the amount of corrosion produced may be very material where the action is perpetual. Boilers with a large extent of heating surface, or with descending flues circulating through the cooler water in the bottom of the boiler before ascending the chimney, will be less corroded internally than boilers in which a large quantity of the heat passes away in the smoke ; and the corrosion of the boiler will be diminished if the interior of any flue passing through the steam be coated with fire brick, so as to prevent the transmission of the heat in that situation. The best practice, however, appears to consist in the transmission of the smoke through a suitable passage on the outside of the boiler, so as to supersede the necessity of carrying any flue through

the steam at all ; or a column of water may be carried round the chimney, into which as much of the feed water may be introduced as the heat of the chimney is capable of raising to the boiling point.*

404. Q.— In steam vessels there are usually several boilers ?

A.— Yes, in steam vessels of considerable power and size.

405. Q.— Are these boilers generally so constructed, that any one of them may be thrown out of use ?

A.— Marine boilers are now generally supplied with stop valves, whereby one boiler may be thrown out of use without impairing the efficacy of the remainder. These stop valves are usually spindle valves of large size, and they are for the most part set in a pipe which runs across the steam chests, connecting the several boilers together. The spindles of these valves should project through stuffing boxes in the covers of the valve chests, and they should be balanced by a weighted lever, and kept in continual action by the steam. If the valves be lifted up, and be suffered to remain up, as is the usual practice, they will become fixed by corrosion in that position, and it will be impossible after some time to shut them on an emergency. These valves should always be easily accessible from the engine room ; and it ought not to be necessary for the coal boxes to be empty to gain access to them.

* Since these recommendations were first given, the plan of carrying the chimney through the steam has been almost universally discontinued.

406. Q.— Should each boiler have at least one safety valve for itself?

A.— Yes; it would be quite unsafe without this provision, as the stop valve might possibly jam. Sometimes valves jam from a distortion in the shape of the boiler when a considerable pressure is put upon it.

407. Q.— How is the admission of the water into the boiler regulated?

A.— The admission of feed water into the boiler is regulated by hand by the engineer by means of cocks, and sometimes by spindle valves raised and lowered by a screw. Cocks appear to be the preferable expedient, as they are less liable to accident or derangement than screw valves, and in modern steam vessels they are generally employed.

408. Q.— At what point of the boiler is the feed introduced?

A.— The feed water is usually conducted from the feed cock to a point near the bottom of the boiler by means of an internal pipe, the object of this arrangement being to prevent the rising steam from being condensed by the entering water. By being introduced near the bottom of the boiler, the water comes into contact in the first place with the bottoms of the furnaces and flues, and extracts heat from them which could not be extracted by water of a higher temperature, whereby a saving of fuel is accomplished. In some cases the feed water is introduced into a casing around the chimney, from whence it descends into the boiler. This plan appears to be an expedient one when the boiler is short of heating surface, and

more than a usual quantity of heat ascends the chimney; but in well proportioned boilers a water casing round the chimney is superfluous. When a water casing is used the boiler is generally fed by a head of water, the feed water being forced up into a small tank, from whence it descends into the boiler by the force of gravity, while the surplus runs to waste, as in the feeding apparatus of land engines.

409. Q.—Suppose that the engineer should shut off the feed water from the boilers while the engine was working, what would be the result?

A.—The result would be to burst the feed pipes, except for a safety valve placed on the feed pipe between the engine and the boilers, which safety valve opens when any undue pressure comes upon the pipes, and allows the water to escape. There is, however, generally a cock on the suction side of the feed pump, which regulates the quantity of water drawn into the pump. But there must be cocks on the boilers also to determine into which boiler the water shall be chiefly discharged, and these cocks are sometimes all shut accidentally at the same time.

410. Q.—Is there no expedient in use in steam vessels for enabling the position of the water level in the boiler to determine the quantity of feed water admitted?

A.—In some steam vessels floats have been introduced to regulate the feed, but their action cannot be depended on in agitated water, if applied after the common fashion. Floats would probably answer if placed in a cylinder which communicates with the water in the boiler by means of small holes; and a

disc of metal might be attached to the end of a rod extending beneath the water level, so as to resist irregular movements from the motion of the ship at sea, which would otherwise impair the action of the apparatus.

411. *Q.*—How is the proper level of the water in the boiler of a steam vessel maintained when the engine is stopped for some time, and the boiler is blowing off steam?

A.—By means of a separate pump worked sometimes by hand, but usually by a small separate engine called the Donkey engine. This pump, by the aid of suitable cocks, will pump from the sea into the boiler; from the sea upon deck, either to wash decks or to extinguish fire; and from the bilge overboard, through a suitable orifice in the side of the ship.

LOCOMOTIVE BOILERS.

412. *Q.*—Will you recapitulate the general features of locomotive boilers?

A.—Locomotive boilers consist of three portions—the barrel containing the tubes, the fire box, and the smoke box; of which the barrel, smoke box, and external fire box are always of iron, but the internal fire box is generally made of copper, though sometimes also it is made of iron. The tubes are sometimes of iron, but generally of brass fixed in by ferules. The whole of the iron plates of a locomotive boiler which are subjected to the pressure of steam, should be Lowmoor or Bowling plates of the best

quality; and the copper should be coarse grained, rather than rich or soft, and be perfectly free from irregularities of structure and lamination.

413. Q. — What are the usual dimensions of the barrel?

A. — The thickness of the plates composing the barrel of the boiler varies generally from $\frac{5}{16}$ ths to $\frac{3}{8}$ ths of an inch, and the plates should run in the direction of the circumference, so that the fibres of the iron may be in the direction of the strain. The diameter of the barrel commonly varies from 3 ft. to 3 ft. 6 inches; the diameter of the rivets should be from $\frac{1}{8}$ ths to $\frac{3}{4}$ ths of an inch, and the pitch of the rivets or distance between their centres should be from $\frac{1}{2}$ ths to 2 inches.

414. Q. — How are the fire boxes of a locomotive constructed?

A. — The space between the external and internal fire boxes forms a water space, which must be stayed every $4\frac{1}{2}$ or 5 inches by means of copper or iron stay bolts, screwed through the outer fire box into the metal of the inner fire box, and securely riveted within it: iron stay bolts are as durable as copper, and their superior tenacity gives them an advantage. Sometimes tubes are employed as stays. The internal and external fire boxes are joined together at the bottom by a \mathcal{N} shaped iron, and round the fire door they are connected by means of a copper ring $1\frac{1}{4}$ in. thick, and 2 in. broad, — the inner fire box being dished sufficiently outwards at that point, and the outer fire box sufficiently inwards, to enable a circle of rivets $\frac{3}{4}$ of an inch in diameter passing through the copper

ring and the two thicknesses of iron, to make a watertight joint. The thickness of the plates composing the external fire box is in general $\frac{3}{8}$ ths of an inch if the fire box is circular, and from $\frac{3}{8}$ ths to $\frac{1}{2}$ inch if the fire box is square; and the thickness of the internal fire box is in most cases $\frac{7}{8}$ ths if copper, and from $\frac{3}{8}$ ths to $\frac{7}{8}$ ths of an inch if of iron. Circular internal fire boxes, if made of iron, should be welded rather than riveted, as the rivet heads are liable to be burnt away by the action of the fire; and when the fire boxes are square each side should consist of a single plate, turned over at the edges with a radius of 3 inches, for the introduction of the rivets.

415. Q.—Is there any provision for stiffening the crown of the furnace in a locomotive?

A.—The roof of the internal fire box, whether flat as in Stephenson's engines, or dome shaped as in Bury's, requires to be stiffened with cross stay bars, but the bars require to be stronger and more numerous when applied to a flat surface. The ends of these stay bars rest above the vertical sides of the fire box; and to the stay bars thus extending across the crown, the crown is attached at intervals by means of stay bolts. There are projecting bosses upon the stay bars encircling the bolts at every point where a bolt goes through, but in the other parts they are kept clear of the fire box crown so as to permit the access of water to the metal; and, with the view of facilitating the ascent of the steam, the bottom of each stay bar should be sharpened away in those parts where it does not touch the boiler.

416. Q.—Is any inconvenience experienced from the intense heat in a locomotive furnace?

A.—The fire bars in locomotives have always been a source of trouble, as from the intensity of the heat in the furnace they become so hot as to throw off a scale, and to bend under the weight of the fuel. The best alleviation of these evils lies in making the bars deep and thin: 4 or 5 inches deep by five-eighths of an inch thick on the upper side, and three-eighths of an inch on the under side, are found in practice to be good dimensions. In some locomotives a frame carrying a number of fire bars is made so that it may be dropped suddenly by loosening a catch; but it is found that any such mechanism can rarely be long kept in working order, as the molten clinker by running down between the frame and the boiler will generally glue the frame into its place. It is therefore found preferable to fix the frame, and to lift up the bars by the dart used by the stoker, when any cause requires the fire to be withdrawn. The furnace bars of locomotives are always made of malleable iron, and indeed for every species of boiler malleable iron bars are to be preferred to bars of cast iron, as they are more durable, and may if thin be set closer together, whereby the small coal or coke is saved that would otherwise fall into the ash pit. The ash box of locomotives is made of plate iron a quarter thick: it should not be less than 10 in. deep, and its bottom should be about 9 in. above the level of the rails. The chimney of a locomotive is made of plate iron one-eighth of an inch thick: it is usually of the same diameter as the cylinder, but is better smaller, and

must not stand more than 14 ft. high above the level of the rails.

417. Q.—Are locomotive boilers provided with a steam chest?

A.—The upper portion of the external fire box is usually formed into a steam chest, which is sometimes dome shaped, sometimes semicircular, and sometimes of a pyramidal form, and from this steam chest the steam is conducted away by an internal pipe to the cylinders; but in other cases an independent steam chest is set upon the barrel of the boiler, consisting of a plate iron cylinder, 20 inches in diameter, 2 feet high, and three-eighths of an inch thick, with a dome shaped top, and with the seam welded and the edge turned over to form a flange of attachment to the boiler. The pyramidal dome, of the form employed in Stephenson's locomotives, presents a considerable extent of flat surface to the pressure of the steam, and this flat surface requires to be very strongly stayed with angle irons and tension rods; whereas the semi-globular dome of the kind employed in Bury's engines requires no staying whatever. Latterly, however, these domes over the fire box have been either much reduced in size or abandoned altogether.

418. Q.—Is any beneficial use made of the surplus steam of a locomotive?

A.—To save the steam which is formed when the engine is stationary, a pipe is usually fitted to the boiler, which on a cock being turned conducts the steam into the water in the tender, whereby the feed water is heated, and less fuel is subsequently required. This method of disposing of the surplus steam may be

adopted when the locomotive is descending inclines, or on any occasion where more steam is produced than the engine can consume.

419. Q.—What means are provided to facilitate the inspection and cleaning of locomotive boilers ?

A.—The man hole, or entrance into the boiler, consists of a circular or oval aperture, of about 15 in. diameter, placed in Bury's locomotive at the apex of the dome, and in Stephenson's upon the front of the boiler, a few inches below the level of the rounded part ; and the cover of the man hole in Bury's engine contains the safety valve seats. In whatever situation this man hole is placed, the surfaces of the ring encircling the hole, and of the internal part of the door or cover, should be accurately fitted together by scraping or grinding, so that they need only the interposition of a little red lead to make them quite tight when screwed together. Lead or canvass joints if of any considerable thickness will not long withstand the action of high pressure steam ; and the whole of the joints about a locomotive should be such that they require nothing more than a little paint or putty, or a ring of wire gauze smeared with white or red lead to make them perfectly tight. There must be a mud hole opposite the edge of each water space, if the fire box be square, to enable the boiler to be easily cleaned out, and these holes are most safely closed by doors put on from the inside. A cock for emptying the boiler is usually fixed at the bottom of the fire box, and it should be so placed as to be accessible when the engine is at work, in order that the engine driver may blow off some water if necessary ;

but it must not be in such a position as to send the water blown off among the machinery, as it might carry sand or grit into the bearings, to their manifest injury.

420. *Q.*—Will you state the dimensions of the tube plate and the means of securing the tubes in it?

A.—The tube plates are generally made from five-eighths to three-fourths of an inch thick, but seven-eighths of an inch thick appears to be preferable, as when the plate is thick the holes will not be so liable to change their figure during the process of feruling the tubes: the distance between the tubes should never be made less than three-fourths of an inch, and the holes should be slightly tapered so as to enable the tubes to hold the tube plates together. The tubes are secured in the tube plates by means of taper ferules driven into the ends of the tubes. The ferules are for the most part made of steel at the fire box end, and of wrought iron at the smoke box end, though ferules of malleable cast iron have in some cases been used with advantage: malleable cast iron ferules are almost as easily expanded when hammered cold upon a mandril, as the common wrought iron ones are at a working heat. Spring steel, rolled with a feather edge, to facilitate its conversion into ferules, is supplied by some of the steel-makers of Sheffield, and it appears expedient to make use of steel thus prepared when steel ferules are employed. In cases where ferules are not employed, it may be advisable to set out the tube behind the tube plate by means of an expanding mandril. There are various forms of this instrument. One form is that known as

Prosser's expanding mandril, in which there are six or eight segments, which are forced out by means of a hexagonal or octagonal wedge, which is forced forward by a screw. When the wedge is withdrawn, the segments collapse sufficiently to enable them to enter the tube, and there is an annular protuberance on the exterior circle of the segments, which protuberance, when the mandril is put into the tube, just comes behind the inner edge of the tube plate. When the wedge is tightened up by the screw, the protuberance on the exterior of the segments composing the mandril causes a corresponding bulge to take place in the tube, at the back of the tube plate, and the tube is thereby brought into more intimate contact with the tube plate than would otherwise be the case. There is a steel ring indented into the segments of Prosser's mandril, to contract the segments when the central wedge is withdrawn. A more convenient form of the instrument, however, is obtained by placing the segments in a circular box, with one end projecting; and supporting each segment in the box by a tenon, which fits into a mortice in the cylindrical box. To expand the segments, a round tapered piece of steel, like a drift, is forced into a central hole, round which the segments are arranged. A piece of steel tube, also slit up to enable a central drift to expand it, answers very well; but the thickness of that part of the tube in which there requires to be spring enough to let the mandril expand, requires to be sufficiently reduced to prevent the pieces from cracking when the central drift is driven in by a hammer. The drift is better when made with a globular head, so that it may

be struck back by the hammer, as well as be driven in. An expanding mandril, with a central drift, is more rapid in its operation than when the expansion is produced by means of a screw.

421. Q.—Will you explain the means that are adopted to regulate the admission of steam to the cylinders ?

A. — In locomotives, the admission of the steam from the boiler to the cylinders is regulated by a valve called the regulator, which is generally placed immediately above the internal fire box, and is connected with two copper pipes ; — one conducting steam from the highest point of the dome down to it, and the other conducting the steam that has passed through it along the boiler to the upper part of the smoke box. Regulators may be divided into two sorts, viz., those with sliding valves and steam ports, and those with conical valves and seats, of which the latter kind are the best. The former kind have for the most part consisted of a circular valve and face, with radial apertures, the valve resembling the outstretched wings of a butterfly, and being made to revolve on its central pivot by connecting links between its outer edges, or by its central spindle. In some of Stephenson's engines the regulator consists of a slide valve covering a port on the top of the valve chests. A rod passes from this valve through the smoke box below the boiler, and by means of a lever parallel to the starting lever, is brought up to the engineer's reach. Cocks were at first used as regulators, but were given up, as they were found liable to stick fast. A gridiron slide valve has been used by Stephenson, which con-

sists of a perforated square moving upon a face with an equal number of holes. This plan of a valve gives, with a small movement, a large area of opening. In Bury's engines a sort of conical plug is used, which is withdrawn by turning the handle in front of the fire box: a spiral groove of very large pitch is made in the valve spindle, in which fits a pin fixed to the boiler, and by turning the spindle an end motion is given to it, which either shuts or opens the steam passage according to the direction in which it is turned. The best regulator would probably be a valve of the equilibrium description, such as is used in the Cornish engine: there would be no friction in such a regulator, and it could be opened or shut with a small amount of force. Such valves, indeed, are now sometimes employed for regulators in locomotives.

CHAP. VIII.

CONSTRUCTIVE DETAILS OF ENGINES.

PUMPING ENGINES.

422. Q.— Will you explain the course of procedure in the erection of a pumping engine, such as Boulton and Watt introduced into Cornwall?

A. — The best instructions on this subject are those of Mr. Watt himself, which are as follows: — Having fixed on the proper situation of the pump in the pit, from its centre measure out the distance to the centre of the cylinder, from which set off all the other dimensions of the house, including the thickness of the walls, and dig out the whole of the included ground to the depth of the bottom of the cellar, so that the bottom of the cylinder may stand on a level with the natural ground of the place, or lower if convenient, for the less the height of the house above the ground, the firmer it will be. The foundations of the walls must be laid at least two feet lower than the bottom of the cellar, unless the foundation be firm rock; and care must be taken to leave a small drain into the pit quite through the lowest part of the foundation of the lever wall, to let off any water that may be spilt in the

engine house, or may naturally come into the cellar. If the foundation at that depth does not prove good, you must either go down to a better if in your reach, or make it good by a platform of wood or piles, or both.

423. Q. — These directions refer to the foundations ?

A. — Yes ; but I will now proceed to the other parts. Within the house, low walls must be built to carry the cylinder beams, so as to leave sufficient room to come at the holding down bolts, and the ends of these beams must also be lodged in the wall. The lever wall must be built in the firmest manner, and run solid, course by course, with thin lime mortar care being taken that the lime has not been long slaked. If the house be built of stone, let the stones be large and long, and let many headers be laid through the wall : it should also be a rule, that every stone be laid on the broadest bed it has, and never set on its edge. A course or two above the lintel of the door that leads to the condenser, build into the wall two parallel flat thin bars of iron equally distant from each other, and from the outside and inside of the wall, and reaching the whole breadth of the lever wall. About a foot higher in the wall, lay at every four feet of the breadth of the front, other bars of the same kind at right angles to the former course, and reaching quite through the thickness of the wall ; and at each front corner lay a long bar in the middle of the side walls, and reaching quite through the front wall ; if these bars are 10 feet or 12 feet long it will be sufficient. When the house is built up nearly to the

bottom of the opening under the great beam, another double course of bars is to be built in, as has been directed. At the level of the upper cylinder beams, holes must be left in the walls for their ends, with room to move them laterally, so that the cylinder may be got in; and smaller holes must be left quite through the walls for the introduction of iron bars, which being firmly fastened to the cylinder beams at one end, and screwed at the other or outer end, will serve, by their going through both the front and back walls, to bind the house more firmly together. The spring beams or iron bars fastened to them must reach quite through the back wall, and be keyed or screwed up tight; and they must be firmly fastened to the lever wall on each side, either by iron bars, firm pieces of wood, or long strong stones, reaching far back into the wall. They must also be bedded solidly, and the residue of the opening must be built up in the firmest manner.

424. Q. — If there be a deficiency of water for the purpose of condensation, what course should be pursued?

A. — If there be no water in the neighbourhood that can be employed for the purpose of condensation, it will be necessary to make a pond, dug in the earth, for the reception of the water delivered by the air pump, to the end that it may be cooled and used again for the engine. The pond may be three or four feet deep, and lined with turf, puddled, or otherwise made water tight. Throwing up the water into the air in the form of a jet to cool it, has been found detri-

mental; as the water is then charged with air which vitiates the vacuum.

425. Q. — How is the piston of a pumping engine packed?

A. — To pack the piston, take sixty common-sized white or untarred rope-yarns, and with them plait a gasket or flat rope as close and firm as possible, tapering for eighteen inches at each end, and long enough to go round the piston, and overlapped for that length; coil this rope the thin way as hard as possible, and beat it with a sledge hammer until its breadth answers the place; put it in and beat it down with a wooden drift and a hand mallet, pour some melted tallow all around, then pack in a layer of white oakum half an inch thick, so that the whole packing may have the depth of five to six inches, depending on the size of the engine; finally, screw down the junk ring. The packing should be beat solid, but not too hard, otherwise it will create so great a friction as to prevent the easy going of the engine. Abundance of tallow should be allowed, especially at first; the quantity required will be less as the cylinder grows smooth. In some of the more modern pumping engines, the piston is provided with metallic packing, consisting for the most part of a single ring with a tongue piece to break the joint, and packed behind with hemp. The upper edge of the metallic ring is sharpened away from the inside so as to permit more conveniently the application of hemp packing behind it; and the junk ring is made much the same as if no metallic packing were employed.

426. Q.—Will you explain the mode of putting the engine into operation?

A. — To set the engine going, the steam must be raised until the pressure in the steam pipe is at least equal to three pounds on the square inch; and when the cylinder jacket is fully warmed, and steam issues freely from the jacket cock, open all the valves or regulators; the steam will then forcibly blow out the air or water contained in the eduction pipe, and to get rid of the air in the cylinder, shut the steam valve after having blown through the engine for a few minutes. The cold water round the condenser will condense some of the steam contained in the eduction pipe, and its place will be supplied by some of the air from the cylinder. The steam valve must again be opened to blow out that air, and the operation is to be repeated until the air is all drawn out of the cylinder. When that is the case shut all the valves, and observe if the vacuum gauge shows a vacuum in the condenser; when there is a vacuum equivalent to three inches of mercury, open the injection a very little, and shut it again immediately; and if this produces any considerable vacuum, open the exhausting valve a very little way, and the injection at the same time. If the engine does not now commence its motion, it must be blown through again until it moves. If the engine be lightly loaded, or if there be no water in the pumps, the throttle valve must be kept nearly closed, and the top and exhaustion regulators must be opened only a very little way, else the engine will make its stroke with violence, and perhaps do mischief. If there is much unbalanced weight on the

pump end, the plug which opens the steam valve must be so regulated, that the valve will only be opened very slightly; and if after a few strokes it is found that the engine goes out too slowly, the valve may be then so adjusted as to open wider. The engine should always be made to work full stroke, that is, until the catch pins be made to come within half an inch of the springs at each end, and the piston should stand high enough in the cylinder when the engine is at rest, to spill over into the perpendicular steam pipe any water which may be condensed above it; for if water remain upon the piston, it will increase the consumption of steam. When the engine is to be stopped, shut the injection valve and secure it, and adjust the tappets so as to prevent the exhausting valve from opening and to allow the steam valve to open and remain open, otherwise a partial vacuum may arise in the cylinder, and it may be filled with water from the injection or from leaks. A single acting engine, when it is in good order, ought to be capable of going as slow as one stroke in ten minutes, and as fast as ten strokes in one minute; and if it does not fulfil these conditions, there is some fault which should be ascertained and remedied.

427. Q. — Your explanation has reference to the pumping engine as introduced into Cornwall by Watt: have any modifications been since made upon it?

A. — In the modern Cornish engines the steam is used very expansively, and a high pressure of steam is employed. In some cases a double cylinder engine is used, in which the steam, after having given motion to a small piston on the principle of a high pressure

engine, passes into a larger cylinder, where it operates on the principle of a condensing engine; but there is no superior effect gained by the use of two cylinders, and there is greater complexity in the apparatus. Instead of the lever walls, cast iron columns are now frequently used for supporting the main beam in pumping engines, and the cylinder end of the main beam is generally made longer than the pump end in engines made in Cornwall, so as to enable the cylinder to have a long stroke, and the piston to move quickly, without communicating such a velocity to the pump buckets as will make them work with such a shock as to wear themselves out quickly. A high pressure of steam, too, can be employed where the stroke is long, without involving the necessity of making the working parts of such large dimensions as would otherwise be necessary; for the strength of the parts of a single acting engine will require to be much the same, whatever the length of the stroke may be.

428. Q.—What kind of pump is mostly used in draining deep mines?

A.—The pump now universally preferred is the plunger pump, which admits of being packed or tightened while the engine is at work; but the lowest lift of a mine is generally supplied with a pump on the suction principle, both with the view of enabling the lowest pipe to follow the water with facility as the shaft is sunk deeper, and to obviate the inconvenience of the valves of the pump being rendered inaccessible by any flooding in the mine. The pump valves of deep mines are a perpetual source of expense and trouble, as from the pressure of water upon them

it is difficult to prevent them from closing with violence ; and many expedients have been contrived to mitigate the evil, of which the valve known as Harvey and West's valve has perhaps gained the widest acceptance.

429. Q. — Will you describe Harvey and West's pump valve ?

A. — This valve is a compromise between the equilibrium valve, of the kind employed for admitting the steam to and from the cylinder in single acting engines, and the common spindle valve formerly used for that purpose ; and to comprehend its action, it is necessary that the action of the equilibrium valve, which has been already represented in *fig. 27.*, should first be understood. This valve consists substantially of a cylinder open at both ends, and capable of sliding upon a stationary piston fixed upon a rod the length of the cylinder, which proceeds from the centre of the orifice the valve is intended to close. It is clear, that when the cylinder is pressed down until its edge rests upon the bottom of the box containing it, the orifice of the pipe must be closed, as the steam can neither escape past the edge of the cylinder nor between the cylinder and the piston ; and it is equally clear, that as the pressure upon the cylinder is equal all around it, and the whole of the downward pressure is maintained by the stationary piston, the cylinder can be raised or lowered without any further exertion of force than is necessary to overcome the friction of the piston and of the rod by which the cylinder is raised. Instead of the rubbing surface of a piston, however, a conical valve face between the cylinder and piston is

employed, which is tight only when the cylinder is in its lowest position; and there is a similar face between the edge of the cylinder and the bottom of the box in which it is placed. The moving part of the valve, too, instead of being a perfect cylinder, is bulged outwards in the middle, so as to permit the steam to escape past the stationary piston when the cylindrical part of the valve is raised. It is clear, that if such a valve were applied to a pump, no pressure of water within the pump would suffice to open it, neither would any pressure of water above the valve cause it to shut with violence; and if an equilibrium valve, therefore, be used as a pump valve at all, it must be opened and shut by mechanical means. In Harvey and West's valves, however, the equilibrium principle is only partially adopted; the lower face is considerably larger in diameter than the upper face, and the difference constitutes an annulus of pressure, which will cause the valve to open or shut with the same force as a spindle valve of the area of the annulus. To deaden the shock still more effectually, the lower face of the valve is made to strike upon end wood driven into an annular recess in the pump bucket; and valves thus constructed work with very little noise or tremor; but it is found in practice, that the use of Harvey and West's valve, or any contrivance of a similar kind, adds materially to the load upon the pump, especially in low lifts where the addition of a load to the valve makes a material addition to the total resistance which the engine has to overcome. Instead of end wood driven into a recess for the valve to strike upon, a mixture of tin and lead cast in a

recess is now frequently used, and is found to be preferable to the wood.

430. *Q.*—Is there any other kind of pump valve which is free from the shocks incidental to the working of common valves?

A.—In some cases india rubber valves are used for pumps, with the effect of materially mitigating the shock; but they require frequent renewal, and are of inferior eligibility in their action to the slide valve, which might in many cases be applied to pumps without inconvenience.

431. *Q.*—Could not a form of pump be devised capable of working without valves at all?

A.—It appears probable, that by working a common bucket-valve pump at a high speed, a continuous flow of water might be maintained through the pipes in such a way as to render the existence of other valves superfluous after once the action was begun; the momentum of the moving water acting in fact as valves. The centrifugal pump, however, threatens to supersede other pumps for low lifts; and if the centrifugal pump be employed, there will be no necessity for pump valves at all. There is less loss of effect by the centrifugal pump than by many common pumps.

482. *Q.*—What is the best form of the centrifugal pump?

A.—Appold's pump, which consists of a number of bent blades arranged in much the same manner as a revolving fan for air, is the species of centrifugal pump which has been most employed for irrigation, and other purposes requiring only low lifts. For high

lifts, such as draining deep mines, the centrifugal pump has not yet been employed ; neither has Giffard's injector, which in some cases appears applicable. The introduction of the centrifugal pump would obviously extinguish the single acting engine, as rotative engines working at a high speed would be the most appropriate form of engine where the centrifugal pump was employed.

433. Q.—This would not be a heavy deprivation ?

A.—The single acting engine is a remnant of engineering barbarism which must now be superseded by more compendious contrivances. The Cornish engines, though rudely manufactured, are very expensive in production, as a large engine does but little work ; whereas by employing a smaller engine, moving with a high speed, the dimensions may be so far diminished that the most refined machinery may be obtained at less than the present cost.

434. Q.—Are not the Cornish engines more economical in fuel than other engines ?

A.—It is a mistake to suppose that there is any peculiar virtue in the existing form of Cornish engine to make it economical in fuel, or that a less lethargic engine would necessarily be less efficient. The large duty of the engines in Cornwall is traceable to the large employment of the principle of expansion, and to a few other causes which may be made of quite as decisive efficacy in smaller engines working with a quicker speed ; and there is therefore no argument in the performance of the present engines against the proposed substitution.

VARIOUS FORMS OF MARINE ENGINES.

435. Q.—What species of paddle engine do you consider to be the best?

A.—The oscillating engine.

436. Q.—Will you explain the grounds of that preference?

A.—The engine occupies little space, consists of few parts, is easily accessible for repairs, and may be both light and strong at the same time. In the case of large engines the crank in the intermediate shaft is a disadvantage, as it is difficult to obtain such a forging quite sound. But by forging it in three cranked flat bars, which are then laid together and welded into a square shaft, a sound forging will be more probable, and the bars should be rounded a little on the sides which are welded to allow the scoriæ to escape during that operation. It is important in so large a forging not to let the fire be too fierce, else the surface of the iron will be burnt before the heart is brought to a welding heat. In some cases in oscillating engines the air pump has been wrought by an eccentric, and that may at any time be done where doubt of obtaining a sound intermediate shaft is entertained; but the precaution must be taken to make the eccentric very wide so as to distribute the pressure over a large surface, else the eccentric will be apt to heat.

437. Q.—Have not objections been brought against the oscillating engine?

A.—In common with every other improvement, the oscillating engine, at the time of its introduction,

encountered much opposition. The cylinder, it was said, would become oval, the trunnion bearings would be liable to heat and the trunnion joints to leak, the strain upon the trunnions would be apt to bend in or bend out the sides of the cylinder; and the circumstance of the cylinder being fixed across its centre, while the shaft requires to accommodate itself to the working of the ship, might, it was thought, be the occasion of such a strain upon the trunnions as would either break them or bend the piston rod. It is a sufficient reply to these objections to say that they are all hypothetical, and that none of them in practice have been found to exist—to such an extent at least as to occasion any inconvenience; but it is not difficult to show that they are altogether unsubstantial, even without a recourse to the disproofs afforded by experience.

438. *Q.*—Is there not a liability in the cylinder to become oval from the strain thrown on it by the piston?

A.—There is, no doubt, a tendency in oscillating engines for the cylinder and the stuffing box to become oval, but after a number of years' wear it is found that the amount of ellipticity is less than that which is found to exist in the cylinders of side lever engines after a similar trial. The resistance opposed by friction to the oscillation of the cylinder is so small, that a man is capable of moving a large cylinder with one hand; whereas in the side lever engine, if the parallel motion be in the least untrue, which is, at some time or other, an almost inevitable condition, the piston is pushed with great force against the side of the cy-

linder, whereby a large amount of wear and friction is occasioned. The trunnion bearings, instead of being liable to heat like other journals, are kept down to the temperature of the steam by the flow of steam passing through them; and the trunnion packings are not liable to leak when the packings, before being introduced, are squeezed in a cylindrical mould.

439. *Q.*—Might not the eduction trunnions be immersed in water?

A.—In some cases a hollow, or lantern brass, about one-third or one-fourth the length of the packing space, and supplied with steam or water by a pipe, is introduced in the middle of the packing, so that if there be any leakage through the trunnion, it will be a leakage of steam or water, which will not vitiate the vacuum; but in ordinary cases this device will not be necessary, and it is not commonly employed. It is clear that there can be no buckling of the sides of the cylinder by the strain upon the trunnions, if the cylinder be made strong enough, and in cylinders of the ordinary thickness such an action has never been experienced; nor is it the fact, that the intermediate shaft of steam vessels, to which part alone the motion is communicated by the engine, requires to adapt itself to the altering forms of the vessel, as the engine and intermediate shaft are rigidly connected, although the paddle shaft requires to be capable of such an adaptation. Even if this objection existed, however, it could easily be met by making the crank pin of the ball and socket fashion, which would permit the position of the intermediate shaft, relatively with that of the cylinder, to be slightly

changed, without throwing an undue strain upon any of the working parts.

440. Q.—Is the trunk engine inferior to the oscillating?

A.—A very elegant and efficient arrangement of trunk engine suitable for paddle vessels has latterly been employed by Messrs. Rennie, of which all the parts resemble those of Penn's oscillating engine except that the cylinders are stationary instead of being movable; and a round trunk or pipe set upon the piston, and moving steam tight through the cylinder cover, enables the connecting rod which is fixed to the piston to vibrate within it to the requisite extent. But the vice of all trunk engines is that they are necessarily more wasteful of steam, as the large mass of metal entering into the composition of the trunk, moving as it does alternately into the atmosphere and the steam, must cool and condense a part of the steam. The radiation of heat from the interior of the trunk will have the same operation, though in vertical trunk engines the loss from this cause might probably be reduced by filling the trunk with oil, so far as this could be done without the oil being spilt over the edge.

441. Q.—What species of screw engine do you consider the best?

A.—I am inclined to give the preference to a variety of the horizontal steeple engine, such as was first used in H. M. S. Amphion. In this engine the cylinders lie on their sides, and they are placed near the side of the vessel with their mouths pointing to the keel. From each cylinder two long piston rods

proceed across the vessel to a cross head working in guides; and from this cross head a connecting rod returns back to the centre of the vessel and gives

Fig. 35.

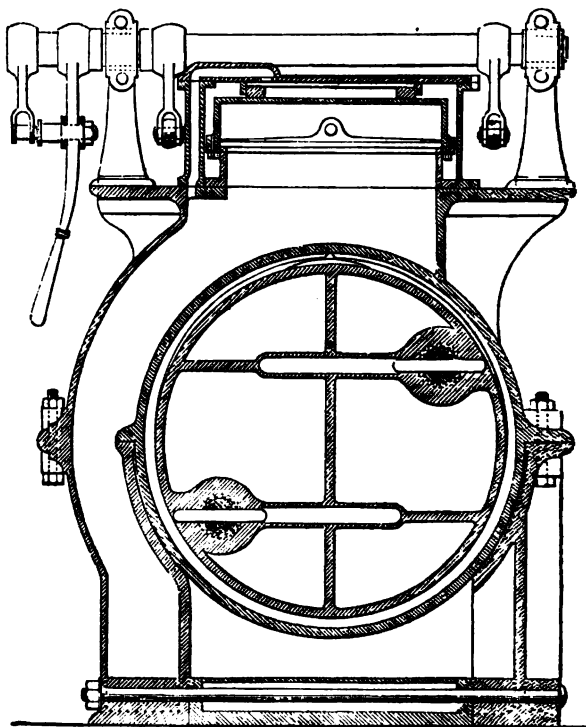

CROSS SECTION OF ONE OF THE CYLINDERS OF THE AMBRION.

motion to the crank. The piston rods are placed in the piston, as shown in *fig. 35.*, and one of them passes above the crank shaft, and the other below the crank shaft. The cross head lies in the same horizontal plane as the centre of the cylinder, and a lug projects upwards from the cross head to engage one piston rod, and downwards from the cross head to engage the other piston rod. The air pump is double acting, and its piston or bucket has the same stroke as the piston of the engine. The air pump bucket derives its motion from an arm on the cross head, and a similar arm is usually employed in engines of this class to work the feed and bilge pumps.

442. Q.—Is not inconvenience experienced in direct acting screw engines from the great velocity of their motion?

A.—Not if they are properly constructed; but they require to be much stronger, to be fitted with more care, and to have the bearing surfaces much larger than is necessary in engines moving slowly. The momentum of the reciprocating parts should also be balanced by a weight applied to the crank or crank shaft, as is done in locomotives. A very convenient arrangement for obtaining surface is to form the crank of each engine of two cast iron discs cast with heavy sides, the excess of weight upon the heavy sides being nearly equal to that of the piston and its connections. When the piston is travelling in one direction the weights are travelling in the opposite; and the momentum of the piston and its attachments, which is arrested at each reciprocation, is just balanced by the equal and opposite momentum of the weights. One

advantage of the horizontal engine is, that a single engine may be employed, whereby greater simplicity of the machinery and greater economy of fuel will be obtained, since there will be less radiating surface in one cylinder than in two.

CYLINDERS, PISTONS, AND VALVES.

443. *Q.*—Is it a beneficial practice to make cylinders with steam jackets ?

A.—In Cornwall, where great attention is paid to economy of fuel, all the engines are made with steam jackets, and in some cases a flue winds spirally round the cylinder, for keeping the steam hot. Mr. Watt in his early practice discarded the steam jacket for a time, but resumed it again, as he found its discontinuance occasioned a perceptible waste of fuel; and in modern engines it has been found that where a jacket is used less coal is consumed than where the use of a jacket is rejected. The cause of this at one time was not of very easy perception, for the jacket exposes a larger radiating surface for the escape of the heat than the cylinder; but since Joule's researches the result is known to be consequent on the superior economy of high temperatures in the production of power. The exterior of the cylinder, or jacket, should be covered with several plies of felt, and then be cased in timber, which must be very narrow, the boards being first dried in a stove, and then bound round the cylinder with hoops, like the staves of a cask. In many of the Cornish engines the steam is let into casings formed in the cylinder cover and cylinder

bottom, for the further economisation of the heat, and the cylinder stuffing box is made very deep, and a lantern or hollow brass is introduced into the centre of the packing, into which brass the steam gains admission by a pipe provided for the purpose ; so that in the event of the packing becoming leaky, it will be steam that will be leaked into the cylinder instead of air, which, being incondensable, would impair the efficiency of the engine. A lantern brass, of a similar kind, is sometimes introduced into the stuffing boxes of oscillating engines, but its use there is to receive the lateral pressure of the piston rod, and thus take any strain off the packing.

444. Q. — Will you explain the proper course to pursue in the production of cylinders ?

A. — In all engines the valve casing, if made in a separate piece from the cylinder, should be attached by means of a metallic joint, as such a barbarism as a rust joint in such situations is no longer permissible. In the case of large engines with valve casings suitable for long slides, an expansion joint in the valve casing should invariably be inserted, otherwise the steam, by gaining admission to the valve casing before it can enter the cylinder, expands the casing while the cylinder remains unaltered in its dimensions, and the joints are damaged, and in some cases the cylinder is cracked by the great strain thus introduced. The chest of the blow-through valve is very commonly cast upon the valve casing ; and in engines where the cylinders are stationary this is the most convenient practice. All engines, where the valve is not of such a construction as to leave the face when a pressure

exceeding that of the steam is created in the cylinder by priming or otherwise, should be provided with an escape valve to let out the water, and such valve should be so constructed that the water cannot fly out with violence over the attendants; but it should be conducted away by a suitable pipe, to a place where its discharge can occasion no inconvenience. The stuffing boxes of all engines which cannot be stopped frequently to be repacked, should be made very deep: metallic packing in the stuffing box has been used in some engines, consisting in most instances of one or more rings, cut, sprung, and slipped upon the piston rod before the cross head is put on, and packed with hemp behind. This species of packing answers very well when the parallel motion is true, and the piston rod free from scratches, and it accomplishes a material saving of tallow. In some cases a piece of sheet brass, packed behind with hemp, has been introduced with good effect, a flange being turned over on the under edge of the brass to prevent it from slipping up or down with the motion of the rod. The sheet brass speedily puts an excellent polish upon the rod, and such a packing is more easily kept, and requires less tallow than where hemp alone is employed. In side lever marine engines the attachments of the cylinder to the diagonal stay are generally made of too small an area, and the flanges are made too thick. A very thick flange cast on any part of a cylinder endangers the soundness of the cylinder, by inducing an unequal contraction of the metal; and it is a preferable course to make the flange for the attachment or the framing thin, and the surface large—the bolts being turned

bolts and nicely fitted. If from malformation in this part the framing works to an inconvenient extent, the best expedient appears to be the introduction of a number of steel tapered bolts, the holes having been previously bored out; and if the flanges be thick enough, square keys may also be introduced, half into one flange and half into the other, so as to receive the strain. If the jaw cracks or breaks away, however, it will be best to apply a malleable iron hoop round the cylinder to take the strain, and this will in all cases be the preferable expedient, where from any peculiarities of structure there is a difficulty in introducing bolts and keys of sufficient strength.

445. Q.—Which is the most eligible species of piston?

A.—For large engines, pistons with a metallic packing, consisting of a single ring, with the ends morticed into one another, and a piece of metal let in flush over the joint and riveted to one end of the ring, appears to be the best species of piston; and if the cylinder be oscillating, it will be expedient to chamfer off the upper edge of the ring on the inner side, and to pack it at the back with hemp. If the cylinder be a stationary one, springs may be substituted for the hemp packing, but in any case it will be expedient to make the vertical joints of the ends of the ring run a little obliquely, so as to prevent the joint forming a ridge in the cylinder. For small pistons two rings may be employed, made somewhat eccentric internally to give a greater thickness of metal in the centre of the ring: these rings must be set one above the other in the cylinder, and the joints, which are oblique,

must be set at right angles with one another, so as to obviate any disposition of the rings, in their expansion, to wear the cylinder oval. The rings must first be turned a little larger than the diameter of the cylinder, and a piece is then to be cut out, so that when the ends are brought together the ring will just enter within the cylinder. The ring, while retained in a state of compression, is then to be put in the lathe and turned very truly, and finally it is to be hammered on the inside with the small end of the hammer, to expand the metal, and thus increase the elasticity.

446. Q. — The rings should be carefully fitted to one another laterally?

A. — The rings are to be fitted laterally to the piston, and to one another, by scraping — a steady pin being fixed upon the flange of the piston, and fitting into a corresponding hole in the lower ring, to keep the lower ring from turning round; and a similar pin being fixed into the top edge of the lower ring to prevent the upper ring from turning round; but the holes into which these pins fit must be made oblong, to enable the rings to press outward as the rubbing surfaces wear. In most cases it will be expedient to press the packing rings out with springs where they are not packed behind with hemp, and the springs should be made very strong, as the prevailing fault of springs is their weakness. Sometimes short bent springs, set round at regular intervals between the packing rings and body of the piston, are employed, the centre of each spring being secured by a steady pin or bolt screwed into the side of the piston; but it will not signify much what kind of springs is used,

provided they have sufficient tension. When pistons are made of a single ring, or of a succession of single rings, the strength of each ring should be tested previously to its introduction into the piston, by means of a lever loaded by a heavy weight.

447. Q. — What kind of piston is employed by Messrs. Penn ?

A. — Messrs. Penn's piston for oscillating engines has a single packing ring, with a tongue piece, or mortice end, made in the manner already prescribed. The ring is packed behind with hemp packing, and the piece of metal which covers the joint is a piece of thick sheet copper or brass, and is indented into the iron of the ring, so as to offer no obstruction to the application of the hemp. The ring is fitted to the piston only on the under edge: the top edge is rounded to a point from the inside, and the junk ring does not bear upon it, but the junk ring squeezes down the hemp packing between the packing ring and the body of the piston.

448. Q. — How should the piston rod be secured to the piston ?

A. — The piston rod, where it fits into the piston, should have a good deal of taper; for if the taper be too small the rod will be drawn through the hole, and the piston will be split asunder. Small grooves are sometimes turned out of the piston rod above and below the cutter hole, and hemp is introduced in order to make the piston eye tight. Most piston rods are fixed to the piston by means of a gib and cutter, but in some cases the upper portion of the rod within the eye is screwed, and it is fixed into the piston by means

of an indented nut. This nut is in some cases hexagonal, and in other cases the exterior forms a portion of a cone which completely fills a corresponding recess in the piston; but nuts made in this way become rusted into their seat after some time, and cannot be started again without much difficulty. Messrs. Ravenhill, Salkeld, and Co. fix in their piston rods by means of an indented hexagonal nut, which may be started by means of an open box key. The thread of the screw is made flat upon the one side and much slanted on the other, whereby a greater strength is secured, without creating any disposition to split the nut. In side lever engines it is a judicious practice to add a nut to the top of the piston rod, in addition to the cutter for securing the piston rod to the cross head. In a good example of an engine thus provided, the piston rod is 7 in. in diameter, and the screw 5 in.; the part of the rod which fits into the cross head eye is 1 ft. 5½ in. long, and tapers from 6½ in. to 6¼ in. diameter. This proportion of taper is a good one: if the taper be less, or if a portion of the piston rod within the cross head eye be left untapered, as is sometimes the case, it is very difficult to detach the parts from one another.

449. Q.—Which is the most beneficial construction of slide valve?

A. — The best construction of slide valve appears to be that adopted by Messrs. Penn for their larger engines, and which consists of a three ported valve, to the back of which a ring is applied of an area equal to that of exhaustion port, and which, by bearing steam tight against the back of the casing, so

that a vacuum may be maintained within the ring, puts the valve in equilibrium, so that it may be moved with an inconsiderable exercise of force. The back of the valve casing is put on like a door, and its internal surface is made very true by scraping. There is a hole through the valve so as to conduct away any steam which may enter within the ring by leakage, and the ring is kept tight against the back of the casing by means of a ring situated beneath the bearing ring, provided with four lugs, through which bolts pass tapped into bosses on the back of the valve; and, by unscrewing these bolts,—which may be done by means of a box key which passes through holes in the casing closed with screwed plugs,—the lower ring is raised upwards, carrying the bearing ring before it. The rings must obviously be fitted over a boss upon the back of the valve; and between the rings, which are of brass, a gasket ring is interposed to compensate by its compressibility for any irregularity of pressure, and each of the bolts is provided with a ratchet collar to prevent it from turning back, so that the engineer, in tightening these bolts, will have no difficulty in tightening them equally, if he counts the number of clicks made by the ratchet. Where this species of valve is used, it is indispensable that large escape valves be applied to the cylinder, as a valve on this construction is unable to leave the face. In locomotive engines, the valve universally employed is the common three ported valve.

450. Q. — Might not an equilibrium slide valve be so constructed by the interposition of springs, as to

enable it to leave the cylinder face when an internal force is applied?

A. — That can no doubt be done, and in some engines has been done. In the screw steamer *Azof*, the valve is of the equilibrium construction, but the plate which carries the packing on which the top ring rests, is an octagon, and fits into an octagonal recess on the back of the valve. Below each side of the octagon there is a bent flat spring, which lifts up the octagonal plate, and with it the packing ring against the back of the valve casing; and should water get into the cylinder, it escapes by lifting the valve, which is rendered possible by the compressibility of the springs. An equivalent arrangement is shown in *figs.* 36. and 37., where the ring is lifted by spiral springs.

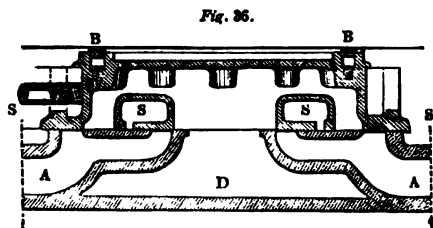

EQUILIBRIUM GRIDIRON SLIDE VALVE.

Longitudinal Section.

Scale $\frac{1}{4}$ inch = 1 foot.

451. *Q.* — What species of valve is that shown in *figs.* 36. and 37.?

A. — It is an equilibrium gridiron valve; so called because it lets the steam in and out by more than one port. \blacktriangle \blacktriangle are the ordinary steam passages to the top

Fig. 37.

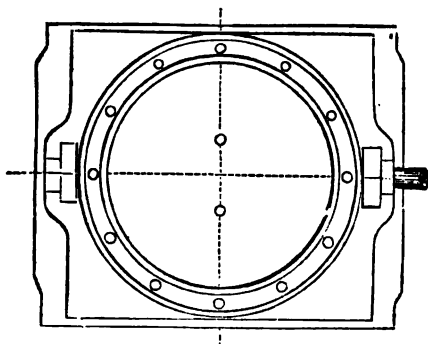

EQUILIBRIUM GRIDIRON SLIDE VALVE.

Back View with Ring removed.

Scale $\frac{1}{4}$ inch = 1 foot

and bottom of the cylinder; B B is the ring which rubs against the back of the valve casing, and D is the eduction passage. s s s s shows the limits of the steam space, for the steam penetrates to the central chamber s s by the sides of the valve. When the valve is opened upon the steam side, the cylinder receives steam through both ports at that end of the cylinder, and both ports at the other end of the cylinder are at the same time open to the eduction. The benefit of this species of valve is, that it gives the same opening of the valve that is given in ordinary engines, with half the amount of travel; or if three ports were made instead of two, then it would give the same area of opening that is given in common engines with one-third the amount of travel.

For direct acting screw engines this species of valve is now extensively used.

452. Q.— Will you describe the configuration and mode of attachment of the eccentric by which the valve is moved ?

A. — In marine engines, whether paddle or screw, if moving at a slow rate of speed, the eccentric is generally loose upon the shaft, for the purpose of backing, and is furnished with a back balance and catches, so that it may stand either in the position for going ahead, or in that for going astern. The body of the eccentric is of cast iron, and it is put on the shaft in two pieces. The halves are put together with rebated joints to keep them from separating laterally, and they are prevented from sliding out by round steel pins, each ground into both halves: square keys would probably be preferable to round pins in this arrangement, as the pins tend to wedge the jaws of the eccentric asunder. In some cases the halves of the eccentric are bolted together by means of flanges, which is, perhaps, the preferable practice. The eccentric hoop in marine and land engines is generally of brass: it is expedient to cast an oil cup on the eccentric hoop, and, where practicable, a pan should be placed beneath the eccentric for the reception of the oil droppings. The notch of the eccentric rod for the reception of the pin of the valve shaft is usually steeled, to prevent inconvenient wear; for when the sides of the notch wear, the valve movement is not only disturbed, but it is very difficult to throw the eccentric rod out of gear. It is found to be preferable, however, to fit this notch with a brass

bush, for the wear is then less rapid, and it is an easy thing to replace this bush with another when it becomes worn. The eccentric catches of the kind usually employed in marine engines, sometimes break off at the first bolt hole, and it is preferable to have a bolt in advance of the catch face, or to have a hoop encircling the shaft with the catches welded on it, the hoop itself being fixed by bolts or a key. This hoop may either be put on before the cranks in one piece or afterwards in two pieces.

453. Q.—Are such eccentrics used in direct acting screw engines?

A. — No; direct acting screw engines are usually fitted with the link motion and two fixed eccentrics

AIR PUMP AND CONDENSER.

454. Q.—What are the details of the air pump?

A. — The air pump bucket and valves are all of brass in modern marine engines, and the chamber of the pump is lined with copper, or made wholly of brass, whereby a single boring suffices. When a copper lining is used, the pump is first bored out, and a bent sheet of copper is introduced, which is made accurately to fill the place, by hammering the copper on the inside. Air pump rods of Muntz's metal or copper are much used. Iron rods covered with brass are generally wasted away where the bottom cone fits into the bucket eye, and if the casing be at all porous the water will insinuate itself between the casing and the rod and eat away the iron. If iron rods covered with brass be used, the brass casing should come some

distance into the bucket eye ; the cutter should be of brass, and a brass washer should cover the under side of the eye, so as to defend the end of the rod from the salt water. Rods of Muntz's metal are probably on the whole to be preferred. It is a good practice to put a nut on the top of the rod, to secure it more firmly in the cross head eye, where that plan can be conveniently adopted. The part of the rod which fits into the cross head eye should have more taper when made of copper or brass, than when made of iron ; as, if the taper be small, the rod may get staved into the eye, whereby its detachment will be difficult.

455. Q.—What species of packing is used in air pumps ?

A.—Metallic packing has in some instances been employed in air pump buckets, but its success has not been such as to lead to its further adoption. The packing commonly employed is hemp. A deep solid block of metal, however, without any packing, is often employed with a satisfactory result ; but this block should have circular grooves cut round its edge to hold water. Where ordinary packing is employed, the bucket should always be made with a junk ring, whereby the packing may be easily screwed down at any time with facility. In slow moving engines the bucket valve is generally of the spindle or pot-lid kind, but butterfly valves are sometimes used. The foot and delivery valves are for the most part of the flap or hanging kind. These valves all make a considerable noise in working, and are objectionable in many ways. Valves on Belidor's construction, which is in effect that of a throttle valve hung off the centre,

were some years ago proposed for the delivery and foot valves; and it appears probable that their operation would be more satisfactory than that of the valves usually employed.

456. *Q.* — Where is the delivery valve usually situated?

A. — Some delivery valve seats are bolted into the mouth of the air pump, whereby access to the pump bucket is rendered difficult: but more commonly the delivery valve is a flap valve exterior to the pump. If delivery valve seats be put in the mouth of the air pump at all, the best mode of fixing them appears to be that adopted by Messrs. Maudslay. The top of the pump barrel is made quite fair across, and upon this flat surface a plate containing the delivery valve is set, there being a small ledge all round to keep it steady. Between the bottom of the stuffing box of the pump cover and the eye of the valve seat a short pipe extends encircling the pump rod, its lower end checked into the eye of the valve seat, and its upper end widening out to form the bottom of the stuffing box of the pump cover. Upon the top of this pipe some screws press, which are accessible from the top of the stuffing box gland, and the packing also aids in keeping down the pipe, the function of which is to retain the valve seat in its place. When the pump bucket has to be examined the valve seat may be slung with the cover, so as to come up with the same purchase. For the bucket valves of such pumps Messrs. Maudslay employ two or more concentric ring valves with a small lift. These valves have given a good deal of trouble in some cases, in conse-

quence of the frequent fracture of the bolts which guide and confine the rings; but this is only a fault of detail which is easily remedied, and the principle

Fig. 38.

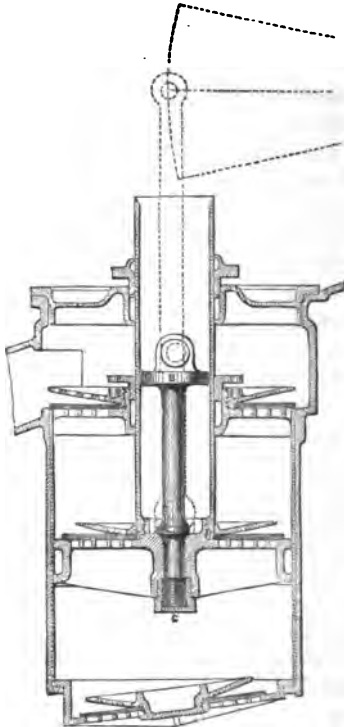

TRUNK AIR PUMP.

Scale $\frac{3}{4}$ inch to 1 foot.

appears to be superior to that of any of the other metallic air pump valves at present in common use.

457. Q.— Are not air pump valves now very generally made of india rubber ?

A.— They are almost invariably so made if the engines are travelling fast, as in the case of direct acting screw engines, and they are very often made of large discs or rings of india rubber, even when the engines travel slowly. A very usual and eligible arrangement for many purposes is that shown in *fig. 38.*, where both foot and delivery valves are situated in the ends of the pump, and they, as well as the valve in the bucket, are made of india rubber rings closing on a grating. The trunk in the air pump enables guide rods to be dispensed with.

458. Q.— The air pump, when double acting, has of course inlet and outlet valves at each end ?

A.— Yes; and the general arrangement of the valves of double acting air pumps, such as are usual in direct acting screw engines, is that represented in the figure of Penn's trunk engine already described in Chapter I. Each inlet and outlet valve consists of a number of india rubber discs set over a perforated brass plate, and each disc is bound down by a bolt in the middle, which bolt also secures a brass guard set above the disc to prevent it from rising too high. The usual configuration of those valves is that represented in *figs. 39, 40, and 41.*; *figs. 39. and 40.* being a section and ground plan of the species of valve used by Messrs. Penn, and *fig. 41.* being a section of that used by Messrs. Maudslay. It is important in these valves to have the india rubber thick, — say about an

Fig. 39.

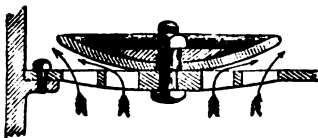

PENN'S DISC VALVE FOR AIR PUMP.
Section.

Fig. 40.

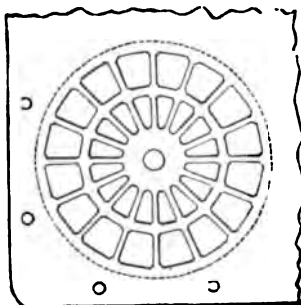

PENN'S DISC VALVE FOR AIR PUMP.
Ground Plan.

Fig. 41.



MAUDSLAY'S DISC VALVE FOR AIR PUMP.
Section.

inch thick for valves eight inches in diameter. It is also advisable to make the central bolts with a nut above and a nut below, and to form the bolt with a countersunk neck, so that it will not fall down when the top nut is removed. The lower point of the bolt should be riveted over on the nut to prevent it from unscrewing, and the top end should have a split pin through the point for the same purpose. The hole through which the bolt passes should be tapped, though the bolt is not screwed into it, so that if a bolt breaks a temporary stud may be screwed into the hole without the necessity of taking out

the whole plate. The guard should be large, else the disc may stretch in the central hole until it comes

over it; but the guard should not permit too much lift of the valve, else a good deal of the water and air will return into the pump at the return stroke before the valve shuts. Penn's guard is rather small, and Maudslay's permits too much lift.

459. Q.—What is the proper area through the valve gratings?

A.—The collective area should be at least equal to the area of the pump piston, and the lower edges of the perforations should be rounded off to afford more free ingress or egress to the water.

460. Q.—Is there much strain thrown on the plates in which the valves are set?

A.—A good deal of strain; and in the earlier direct acting screw engines these plates were nearly in every case made too light. They should be made thick, have strong feathers upon them, and be very securely bolted down with split pins at the points of the bolts, to prevent them from unscrewing. The plate will be very apt to be broken should some of the bolts become loose. Of course all the bolts and split pins, as well as the plates and guards, must be of brass.

461. Q.—How are the plates to be taken out should that become necessary?

A.—They are usually taken out through a door in the top of the hot well provided for that purpose, which door should be as large as the plates themselves; and it is a good precaution to cast upon this door—which will be of cast iron—six or eight stout projecting feet which will press upon the top of the outlet or delivery valve plate when the door is screwed

down. The upper or delivery valve plate and the lower or foot valve plate should have similar feet. A large part of the strain will thus be transferred from the plates to the door, which can easily be made strong enough to sustain it. It is advisable that the plates should lie at an angle so that the shock of the water may not come upon the whole surface at once.

462. *Q.* — Does the double acting air pump usual in direct acting screw engines, produce as good a vacuum as the single acting air pump usual in paddle engines?

A. — It will do so if properly constructed ; but I do not know of any case of a double acting air pump, with india rubber valves, which has been properly constructed.

463. *Q.* — What is the fault of such pumps ?

A. — The pump frequently works by starts, as if at times it did not draw at all, and then again on a sudden gorged itself with water, so as to throw a great strain upon the working parts. The vacuum, moreover, is by no means so good as it should be, and it is a universal vice of direct acting screw engines that the vacuum is defective. I have been at some pains to investigate the causes of this imperfection ; and in a sugar house engine fitted with pumps like those of a direct acting screw engine, to maintain a vacuum in the pans, I found that a better vacuum was produced when the engine was going slowly than when it was going fast ; which is quite the reverse of what was to have been expected, as the hot water which had to be removed by the condensation of the steam proceeding from the pan, was a constant quan-

tity. In this engine, too, which was a high pressure one, the irregularities of the engine consequent upon the fitful catching of the water by the pump, was more conspicuous, as the working of this vacuum pump was the only work that the engine had to perform.

464. Q.—And were you able to discover the cause of these irregularities?

A.—The main cause of them I found to be the largeness of the space left between the valve plates in this class of pumps, and out of which there is nothing to press the air or water which may be lying there. It consequently happens, that if there be the slightest leakage of air into the pump, this air is merely compressed, and not expelled, by the advance of the air pump piston. It expands again to its former bulk on the return of the pump piston, and prevents the water from entering until there is such an accumulation of pressure in the condenser as forces the water into the pump, when the air being expelled by the water, causes a good vacuum to be momentarily formed in the pump when it gorges itself by taking a sudden gulp of water. So soon, however, as the pressure falls in the condenser and some more air leaks into the pump, the former imperfect action recurs and is again redressed in the same violent manner.

465. Q.—Is this irregular action of the pump the cause of the imperfect vacuum?

A.—It is one cause. Sometimes one end of the pump will alone draw and the other end will be inoperative, although it is equally open to the condenser, and this will chiefly take place at the stuffing box end,

where a leakage of air is more likely to occur. I find, however, that even when both ends of the pump are acting equally and there is no leakage of air at all, the vacuum maintained by a double acting horizontal pump with india rubber valves, is not so good as that maintained by a single acting pump of the kind usual in old engines.

466. Q. — Will you specify more precisely what were the results you obtained?

A. — When the vacuum pan was exhausted by the pumps without any boiling being carried on in the pan, but only a little cold water being let into it, and also into the pumps to enable them to act in their best manner, it was found that whereas with the old pump a vacuum of 114 on the sugar boiler's gauge could be readily obtained, equal to about $29\frac{1}{2}$ inches of mercury, the lowest that could possibly be got with the new horizontal pump was 122 degrees of the sugar boiler's gauge, or 29 inches of mercury, and to get that the engine must not go faster than 10 or 12 strokes per minute. The proper speed of the engine was 75 strokes per minute, but if allowed to go at that speed the vacuum fell to 130 of the sugar maker's gauge, or $28\frac{1}{2}$ inches of mercury. When the steam was let into the worms of the pan so as to boil the water in it, the vacuum was 134 at 75 revolutions of the engine, and went down to 132 at 40 revolutions, but rose again to 135, equal to about $28\frac{1}{2}$ inches of mercury, at 20 revolutions.

467. Q. — To what do you attribute the circumstance of a better vacuum being got at low speeds than at high speeds?

A.— It is difficult to assign the precise reason, but it appears to be a consequence of the largeness of the vacant space between the valve plates. When the piston of the air pump is drawn back, the air contained in this large collection of water will cause it to boil up like soda water ; and when the piston of the pump is forced forward, this air, instead of being expelled, will be again driven into the water. There will consequently be a quantity of air in the pump which cannot be got rid of at all, and which will impair the vacuum as a matter of course.

468. *Q.*— What expedient did you adopt to improve the vacuum in the engine to which you have referred ?

A.— I put blocks of wood on the air pump piston, which at the end of its stroke projected between the valve plates and forced the water out. I also introduced a cock of water at each end of the pump between the valve plates, to insure the presence of water at each end of the pump to force the air out. With these ameliorations the pump worked steadily, and the vacuum obtained became as good as in the old pump. I had previously introduced an injection cock into each end of the air pump in steam vessels, from which I had obtained advantageous results ; and in all horizontal air pumps I would recommend the piston and valve plates to be so constructed that the whole of the water will be expressed by the piston. I would also recommend an injection cock to be introduced at each end of the pump.

PUMPS, COCKS, AND PIPES.

469. Q. — Will you explain the arrangement of the feed pump?

A. — In steam vessels, the feed pump plunger is generally of brass, and the barrel of the pump is sometimes of brass, but generally of cast iron. There should be a considerable clearance between the bottom of the plunger and the bottom of the barrel, as otherwise the bottom of the barrel may be knocked out, should coal dust or any other foreign substance gain admission, as it probably would do if the injection water were drawn at any time from the bilge of the vessel, as is usually done if the vessel springs a leak. The valves of the feed pump in marine engines are generally of the spindle kind, and are most conveniently arranged in a chest, which may be attached in any accessible position to the side of the hot well. There are two side nozzles upon this chest, of which the lower one leads to the pump, and the upper one to the boiler. The pipe leading to the pump is a suction pipe when the plunger ascends, and a forcing pipe when the plunger descends. The plunger in ascending draws the water out of the hot well through the lowest of the valves, and in descending forces it through the centre valve into the space above it, which communicates with the feed pipe. Should the feed cock be shut so as to prevent any feed water from passing through it, the water will raise the topmost valve, which is loaded to a pressure considerably above the pressure of the steam, and escape into the

hot well. This arrangement is neater and less expensive than that of having a separate loaded valve on the feed pipe, with an overflow through the ship's side, as is the more usual practice.

470. *Q.*—Will you describe what precautions are to be observed in the construction of the cocks used in engines?

A.—All the cocks about an engine should be provided with bottoms and stuffing boxes, and reliance should never be placed upon a single bolt passing through a bottom washer for keeping the plug in its place, in the case of any cock communicating with the boiler; for a great strain is thrown upon that bolt if the pressure of the steam be high, and if the plug be made with much taper; and should the bolt break, or the threads strip, the plug will fly out, and persons standing near may be scalded to death. In large cocks, it appears the preferable plan to cast the bottoms in; and the metal of which all the cocks about a marine engine are made, should be of the same quality as that used in the composition of the brasses, and should be without lead, or other deteriorating material. In some cases the bottoms of cocks are burnt in with hard solder, but this method cannot be depended upon, as the solder is softened and wasted away by the hot salt water, and in time the bottom leaks, or is forced out. The stuffing box of cocks should be made of adequate depth, and the gland should be secured by means of four strong copper bolts. The taper of blow-off cocks is an important element in their construction; as, if the taper be too great, the plugs will have a continual tendency to rise, which, if the pack-

ing be slack, will enable grit to get between the faces, while, if the taper be too little, the plug will be liable to jam, and a few times grinding will sink it so far through the shell that the waterways will no longer correspond. One-eighth of an inch deviation from the perpendicular for every inch in height, is a common angle for the side of the cock, which corresponds with one quarter of an inch difference of diameter in an inch of height; but perhaps a somewhat greater taper than this, or one-third of an inch difference in diameter for every inch of height, is a preferable proportion. The bottom of the plug must be always kept a small distance above the bottom of the shell, and an adequate surface must be left above and below the waterway to prevent leakage. Cocks formed according to these directions will be found to operate satisfactorily in practice, while they will occasion perpetual trouble if there be any malformation.

471. Q. — What is the best arrangement and configuration of the blow-off cocks?

A. — The blow-off cocks of a boiler are generally placed some distance from the boiler; but it appears preferable that they should be placed quite close to it, as there are no means of shutting off the water from the pipe between the blow-off cock and the boiler, should fracture or leakage there arise. Every boiler must be furnished with a blow-off cock of its own, independently of the main blow-off cocks on the ship's sides, so that the boilers may be blown off separately, and may be shut off from one another. The preferable arrangement appears to be, to cast upon each blow-off cock a bend for attaching the cock to the bottom of the

boiler, and the plug should stand about an inch in advance of the front of the boiler, so that it may be removed, or re-ground, with facility. The general arrangement of the blow-off pipes is to run a main blow-off pipe beneath the floor plates, across the ship, at the end of the engines, and into this pipe to lead a separate pipe, furnished with a cock, from each boiler. The main blow-off pipe, where it penetrates the ship's side, is furnished with a cock: and in modern steam vessels Kingston's valves are also used, which consist of a spindle or plate valve, fitted to the exterior of the ship, so that if the internal pipe or cock breaks, the external valve will still be operative. Some expedient of this kind is almost necessary, as the blow-off cocks require occasional re-grinding, and the sea cocks cannot be re-ground without putting the vessel into dock, except by the use of Kingston's valves, or some equivalent expedient.

472. Q. — What is the proper construction and situation of the injection cocks, and waste water valves?

A. — The sea injection cocks are usually made in the same fashion as the sea blow-off cocks, and of about the same size, or rather larger. The injection water is generally admitted to the condenser by means of a slide valve, but a cock appears to be preferable, as it is more easily opened, and has not any disposition to shut of its own accord. In paddle vessels the sea injection pipes should be put through the ship's sides in advance of the paddles, so that the water drawn in may not be injuriously charged with air. The waste water pipe passing from the hot well through the

vessel's side is provided with a stop valve, called the discharge valve, which is usually made of the spindle kind, so as to open when the water coming from the air pump presses against it. In some cases this valve is a sluice valve, but the hot well is then almost sure to be split, if the engine be set on without the valve having been opened. The opening of the waste water pipe should always be above the load water line, as it will otherwise be difficult to prevent leakage through the engine into the ship when the vessel is lying in harbour.

473. Q. — What is the best arrangement of gauge cocks and glass gauges?

A. — Gauge cocks are generally very inartificially made, and occasion needless annoyance. They are rarely made with bottoms, or with stuffing boxes, and are consequently, for the most part, adorned with stalactites of salt after a short period of service. The water discharged from them, too, from the want of a proper conduit, disfigures the front of the boiler, and adds to the corrosion in the ash pits. It would be preferable to combine the gauge cocks appertaining to each boiler into a single upright tube, connected suitably with the boiler, and the water flowing from them could be directed downwards into a funnel tube communicating with the bilge. The cocks of the glass tubes, as well as of the gauge cocks, should be furnished with stuffing boxes and with bottoms, unless the water enters through the bottom of the plug, which in gauge cocks is sometimes the case. The glass gauge tubes should always be fitted with a cock at each neck communicating with the boiler, so that

the water and steam may be shut off if the tube breaks; and the cocks should be so made as to admit of the tubes being blown through with steam to clear them, as in muddy water they will become so soiled that the water cannot be seen. The gauge cocks frequently have pipes running up within the boiler, to the end that a high water level may be made consistent with an easily accessible position of the gauge cocks themselves. With the glass tubes, however, this species of arrangement is not possible, and the glass tubes must always be placed in the position of the water level.

474. Q.—What is the proper material of the pipes in steam vessels?

A.—Most of the pipes of marine engines should be made of copper. The steam pipes may be of cast iron, if made very strong, but the waste water pipes should be of copper. Cast iron blow-off pipes have in some cases been employed, but they are liable to fracture, and are dangerous. The blow-off and feed pipes should be of copper, but the waste steam pipe may be of galvanised iron. Every pipe passing through the ship's side, and every pipe fixed at both ends, and liable to be heated and cooled, should be furnished with a faucett or expansive joint; and in the case of cast iron pipes, the part of the pipe fitting into the faucett should be turned. In the distribution of the faucetts of the pipes exposed to pressure, care must be taken that they be so placed that the parts of the pipe cannot be forced asunder, or turned round by the strain, as serious accidents have occurred from the neglect of this precaution.

475. Q.—What is the best mode of making pipes tight where they penetrate the ship's side?

A.—In wooden vessels the pipes where they pierce the ship's side, should be made tight, as follows:—the hole being cut, a short piece of lead pipe, with a broad flange at one end, should be fitted into it, the place having been previously smeared with white lead, and the pipe should then be beaten on the inside, until it comes into close contact all around with the wood. A loose flange should next be slipped over the projecting end of the lead pipe, to which it should be soldered, and the flanges should both be nailed to the timber with scupper nails, white lead having been previously spread underneath. This method of procedure, it is clear, prevents the possibility of leakage down through the timbers; and all, therefore, that has to be guarded against after this precaution, is to prevent leakage into the ship. To accomplish this object, let the pipe which it is desired to attach be put through the leaden hause, and let the space between the pipe and the lead be packed with gasket and white lead, to which a little olive oil has been added. The pipe must have a flange upon it to close the hole in the ship's side; the packing must then be driven in from the outside, and be kept in by means of a gland secured with bolts passing through the ship's side. If the pipe is below the water line the gland must be of brass, but for the waste water pipe a cast iron gland will answer. This method of securing pipes penetrating the side, however, though the best for wooden vessels, will, it is clear, fail to apply to iron ones. In the case of iron vessels, it appears to be the best practice to attach a short iron nozzle, projecting

inwards from the skin, for the attachment of every pipe below the water line, as the copper or brass would waste the iron of the skin if the attachment were made in the usual way.

DETAILS OF THE SCREW AND SCREW SHAFT.

476. Q.—What is the best method of fixing the screw upon the shaft?

A.—The best way is to cut two large grooves in the shaft coming up to a square end, and two corresponding grooves or key seats in the screw boss opposite the arms. Fit into the grooves on the shaft keys with heads, the length of which is equal to half the depth of the boss, and with the ends of the keys bearing against the ends of the grooves in the shaft. Then ship on the propeller, and drive other keys of an equal length from the other side of the boss, so that the points of the keys will nearly meet in the middle; next burr up the edge of the grooves upon the heads of the keys, to prevent them from working back; and finally tap a bolt into the side of the boss to penetrate the shaft. Propellers so fitted will never get slack.

477. Q.—What is the best way of fitting in the screw pipe at the stern?

A.—It should have projecting rings, which should be turned; and cast iron pieces with holes in them, bored out to the sizes of these rings, should be secured to the stern frames, and the pipe be then shipped through all. Before this is done, however, the stern post must be bored out by a template to fit the pipe, and the pipe is to be secured at the end to the stern

post either by a great external nut of cast iron, or by bolts passing through the stern post and through lugs on the pipe. The pipe should be bored throughout its entire length, or be lined with *lignum vite*, and the shaft should be turned so as to afford a very long bearing, which will prevent rapid wear.

478. Q. How is the hole formed in the deadwood of the ship in which the screw works?

A.—A great frame of malleable iron, the size of the hole, is first set up, and the plating of the ship is brought to the edge of this hole, and is riveted through the frame. It is important to secure this frame very firmly to the rest of the ship, with which view it is advisable to form a great palm, like the palm of a vice, on its inner superior corner, which, projecting into the ship, may be secured by breast-hook plates to the sides, whereby the strain which the screw causes will be distributed over the stern, instead of being concentrated on the rivets of the frame.

479. Q.—Are there several lengths of screw shaft?

A.—There are.

480. Q.—How then are these secured to one another?

A.—The best mode of securing the several lengths of shaft together is by forging the shafts with flanges at the ends, which are connected together by bolts, say six strong bolts in each, but the abutting ends of the shafts should be slightly rounded to permit a slight sideplay.

481. Q.—How is the thrust of the shaft received?

A.—In some cases it is received on a number of

metal discs set in a box containing oil; and should one of these discs stick fast from friction, the others will

Fig. 42.

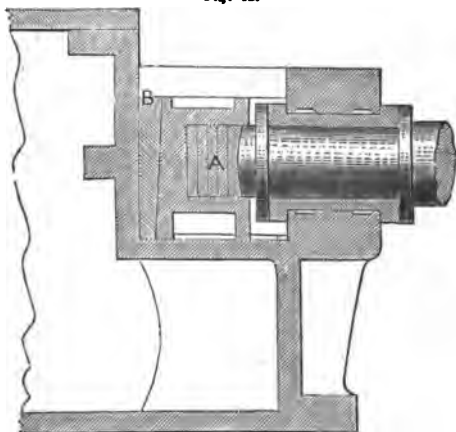

End of the SCREW SHAFT of CORREO, showing the Mode of receiving the Thrust. A, discs; B, tightening wedge.

Fig. 43.

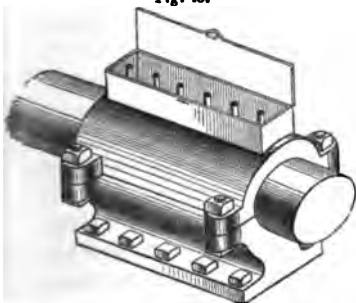
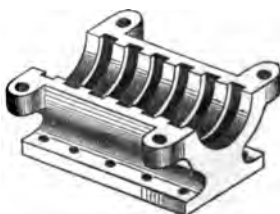

Fig. 44.



PLUMMER BLOCK for receiving Thrust of Screw, as used by Messrs. Penn.

PLUMMER BLOCK with Cap removed

be free to revolve. This arrangement, which is represented in *fig. 42.*, is used pretty extensively, and answers the purpose perfectly. It is of course necessary that the box in which the discs *A* are set, shall be strong enough to withstand the thrust which the screw occasions. Another arrangement still more generally used, is that represented in *figs. 43. and 44.* It is a good practice to make the thrust plummer block with a very long sole in the direction of the shaft so as to obviate any risk of canting or springing forward when the strain is applied, as such a circumstance, if occurring even to a slight extent, would be very likely to cause the bearing to heat.

Fig. 45.

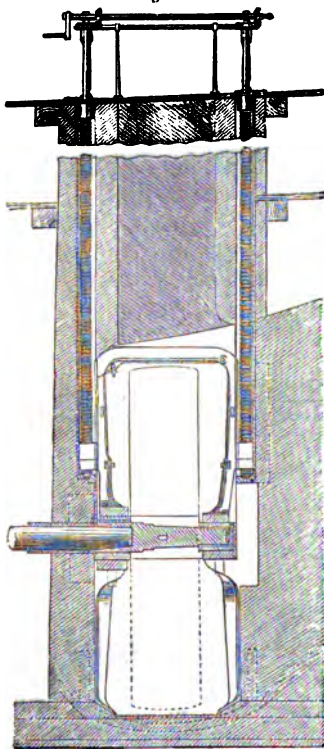

Elevation of Apparatus for lifting Screw of DAUNTLESS.

482. Q.—Are there not arrangements existing in some vessels for enabling the screw

to be lifted out of the water while the vessel is at sea?

A.— There are; but such arrangements are not usual in merchant vessels. One form of apparatus for this purpose is that represented in *fig. 45*. The screw is set on a short shaft in the middle of a sliding frame, which can be raised or lowered in grooves like a window, and the screw shaft within the ship can be protruded or withdrawn by appropriate mechanism, so as to engage or leave free this short shaft as may be required. When the screw has to be lifted, the screw shaft is drawn into the vessel, leaving the short shaft free to be raised up by the sliding frame, and the frame is raised by long screws turned round by a winch purchase on deck. A chain or rope, however, is better for the purpose of raising this frame, than long screws; but the frame should in such case be provided with pall catches like those of a windlass, which, if the rope should break, will prevent the screw from falling.

DETAILS OF THE PADDLES AND PADDLE SHAFT.

483. *Q.*— What are the most important details of the construction of paddle wheels?

A.— The structure of the feathering wheel will be hereafter described in connection with an account of the oscillating engine; and it will be expedient now to restrict any account of the details to the common radial paddle, as applied to ocean steamers. The best plan of making the paddle centres is with square eyes, and each centre should be secured in its

place by means of eight thick keys. The shaft should be burred up against the head of these keys with a chisel, so as to prevent the keys from coming back of their own accord. If the keys are wanted to be driven back, this burr must be cut off, and if made thick, and of the right taper, they may then be started without difficulty. The shaft must of course be forged with square projections on it, so as to be suitable for the application of centres with square eyes. Messrs. Maudslay and Co. bore out their paddle centres, and turn a seat for them on the shaft, afterwards fixing them on the shaft with a single key. This plan is objectionable for the two reasons, that it is insecure when new, and when old is irremovable. The general practice among the London engineers is to fix the paddle arms at the centre to a plate by means of bolts, a projection being placed upon the plates on each side of the arm, to prevent lateral motion; but this method is inferior in durability to that adopted in the Clyde, in which each arm is fitted into a socket by means of a cutter, — a small hole being left opposite to the end of each arm, whereby the arm may be forced back by a drift.

484. Q. — How are the arms attached to the outside rings?

A. — Some engineers join the paddle arms to the outer ring by means of bolts; but unless very carefully fitted, those bolts after a time become slack sideways, and a constant working of the parts of the wheel goes on in consequence. Sometimes the part of the outer ring opposite the arm is formed into a mortice, and the arms are wedged tight in these

holes by wedges driven in on each side; but the plan is an expensive one, and not satisfactory, as the wedges work loose even though riveted over at the point. The best mode of making a secure attachment of the arms to the ring, consists in making the arms with long T heads, and riveting the cross piece to the outer ring with a number of rivets, not of the largest size, which would weaken the outer ring too much. The best way of securing the inner rings to the arms is by means of lugs welded on the arms, and to which the rings are riveted.

485. Q. — What are the scantlings of the paddle floats?

A. — The paddle floats are usually made either of elm or pine; if of the former, the common thickness for large sea-going vessels is about $2\frac{1}{2}$ inches; if of the latter, 3 inches. The floats should have plates on both sides, else the paddle arms will be very liable to cut into the wood, and the iron of the arms will be very rapidly wasted. When the floats have been fresh put on they must be screwed up several times before they come to a bearing. If this be not done, the bolts will be sure to get slack at sea, and all the floats on the weather side may be washed off. The bolts for holding on the paddle floats are made extra strong, on account of the corrosion to which they are subject; and the nuts should be made large, and should be square, so that they may be effectually tightened up, even though their corners be worn away by corrosion. It is a good plan to give the thread of the paddle bolts a nick with a chisel, after the nut has been screwed up, which will prevent the nut from

turning back. Paddle floats, when consisting of more than one board, should be bolted together edge-ways, by means of bolts running through their whole breadth. The floats should not be notched to allow of their projection beyond the outer ring, as, if the sides of the notch be in contact with the outer ring, the ring is soon eaten away in that part, and the projecting part of the float, being unsupported, is liable to be broken off.

486. *Q.* — Do not the wheels jolt sideways when the vessel rolls?

A. — It is usual to put a steel plate at each end of the paddle shafts tightened with a key, to prevent end play when the vessel rolls, but the arrangement is precarious and insufficient. Messrs. Maudslay make their paddle shaft bearings with very large fillets in the corner, with the view of diminishing the evil; but it would be preferable to make the bearings like a common thrust bearing; and, indeed, it would probably be an improvement if most of the bearings about the engine were to be made in the same fashion. The loose end of the crank pin should be made not spheroidal, but consisting of a portion of a sphere; and a brass bush might then be fitted into the crank eye, that would completely encase the ball of the pin, and yet permit the outer end of the paddle shaft to fall without straining the pin, the bush being at the same time susceptible of a slight end motion. The paddle shaft, where it passes through the vessel's side, is usually surrounded by a lead stuffing box, which will yield if the end of the shaft falls; this stuffing box prevents leakage into the ship from the

paddle wheels: but it is expedient, as a further precaution, to have a small tank on the ship's side immediately beneath the stuffing box, with a pipe leading down to the bilge to catch and conduct away any water that may enter around the shaft.

487. *Q.* — How is the outer bearing of the paddle wheels supplied with tallow?

A. — The bearing at the outer end of the paddle shaft is sometimes supplied with tallow, forced into a hole in the plummer block cover, as in the case of water wheels; but for vessels intended to perform long voyages, it is preferable to have a pipe leading down to the oil cup above the journal from the top of the paddle box, through which pipe oil may at any time be supplied.

488. *Q.* — Will you explain the method of putting engines into a steam vessel?

A. — As an illustration of this operation it may be advisable to take the case of a side lever engine, and the method of proceeding is as follows:— First measure across from the inside of paddle bearers to the centre of the ship, to make sure that the central line, running in a fore and aft direction on the deck or beams, usually drawn by the carpenter, is really in the centre. Stretch a line across between the paddle bearers in the direction of the shaft; to this line, in the centre of the ship where the fore and aft mark has been made, apply a square with arms six or eight feet long, and bring a line stretched perpendicularly from the deck to the keelson, accurately to the edge of the square: the lower point of the line where it touches the keelson will be immediately beneath the

marks made upon the deck. If this point does not come in the centre of the keelson, it will be better to shift it a little, so as to bring it to the centre, altering the mark upon the deck correspondingly, provided either paddle shaft will admit of this being done — one of the paddle brackets being packed behind with wood, to give it an additional projection from the side of the paddle bearer. Continue the line fore and aft upon the keelson as nearly as can be judged in the centre of the ship; stretch another line fore and aft through the mark upon the deck, and look it out of winding with the line upon the keelson. Fix upon any two points equally distant from the centre, in the line stretched transversely in the direction of the shaft; and from those points, as centres, and with any convenient radius, sweep across the fore and aft line to see that the two are at right angles; and, if not, shift the transverse line a little to make them so. From the transverse line next let fall a line upon each outside keelson, bringing the edge of the square to the line, the other edge resting on the keelson. A point will thus be got on each outside keelson perpendicularly beneath the transverse line running in the direction of the shaft, and a line drawn between those two points will be directly below the shaft. To this line the line of the shaft marked on the sole plate has to be brought, care being taken, at the same time, that the right distance is preserved between the fore and aft line upon the sole plate, and the fore and aft line upon the central keelson.

489. Q. — Of course the keelsons have first to be properly prepared?

A. — In a wooden vessel, before any part of the machinery is put in, the keelsons should be dubbed fair and straight, and be looked out of winding by means of two straight edges. The art of placing engines in a ship is more a piece of plain common sense than any other feat in engineering, and every man of intelligence may easily settle a method of procedure for himself. Plumb lines and spirit levels, it is obvious, cannot be employed on board a vessel, and the problem consists in so placing the sole plates, without these aids, that the paddle shaft will not stand awry across the vessel, nor be carried forward beyond its place by the framing shouldering up more than was expected. As a plumb line cannot be used, recourse must be had to a square; and it will signify nothing at what angle with the deck the keelsons run, so long as the line of the shaft across the keelsons is squared down from the shaft centre. The sole plates being fixed, there is no difficulty in setting the other parts of the engine in their proper places upon them. The paddle wheels must be hung from the top of the paddle box to enable the shaft to be rove through them, and the cross stays between the engines should be fixed in when the vessel is afloat. To try whether the shafts are in a line, turn the paddle wheels, and try if the distance between the cranks is the same at the upper and under, and the two horizontal centres; if not, move the end of the paddle shaft up or down, backwards or forwards, until the distance between the cranks at all the four centres is the same.

490. **Q.** — In what manner are the engines of a steam vessel secured to the hull?

A. — The engines of a steamer are secured to the hull by means of bolts called holding down bolts, and in wooden vessels a good deal of trouble is caused by these bolts, which are generally made of iron. Sometimes they go through the bottom of the ship, and at other times they merely go through the keelson, — a recess being made in the floor or timbers to admit of the introduction of a nut. The iron, however, wears rapidly away in both cases, even though the bolts are tinned; and it has been found the preferable method to make such of the bolts as pass through the bottom, or enter the bilge, of Muntz's metal, or of copper. In a side lever engine, four Muntz's metal bolts may be put through the bottom at the crank end of the framing of each engine, four more at the main centre, and four more at the cylinder, making twelve through bolts to each engine; and it is more convenient to make these bolts with a nut at each end, as in that case the bolts may be dropped down from the inside, and the necessity is obviated of putting the vessel on very high blocks in the dock, in order to give room to put the bolts up from the bottom. The remainder of the holding down bolts may be of iron, and may, by means of a square neck, be screwed into the timber of the keelsons as wood screws — the upper part being furnished with a nut which may be screwed down upon the sole plate, so soon as the wood screw portion is in its place. If the cylinder be a fixed one it should be bolted down to the sole plate by as many bolts as are employed to attach the cylinder cover, and they should be of copper or brass, in any situation that is not easily accessible.

491. Q. — If the engines become loose, how do you refix them?

A. — It is difficult to fix engines effectually which have once begun to work in the ship, for in time the surface of the keelsons on which the engines bear becomes worn uneven, and the engines necessarily rock upon it. As a general rule, the bolts attaching the engines to the keelsons are too few and of too large a diameter: it would be preferable to have smaller bolts, and a greater number of them. In addition to the bolts going through the keelsons or the vessel's bottom, there should be a large number of wood screws securing the sole plate to the keelson, and a large number of bolts securing the various parts of the engine to the sole plate. In iron vessels, holding down bolts passing through the bottom are not expedient; and there the engine has merely to be secured to the iron plate of the keelsons, which are made hollow to admit of a more effectual attachment.

492. Q. — What are the proper proportions of bolts?

A. — In well formed bolts, the spiral groove penetrates about one-twelfth of the diameter of the cylinder round which it winds, so that the diameter of the solid cylinder which remains is five-sixths of the diameter over the thread. If the strain to which iron may be safely subjected in machinery is one-fifteenth of its utmost strength, or 4000 lbs. on the square inch, then 2180 lbs. may be sustained by a screw an inch in diameter, at the outside of the threads. The strength of the holding down bolts may easily be computed, when the elevating force of the piston or main centre is known; but it is expedient very much to

exceed this strength in practice, on account of the elasticity of the keelsons, the liability to corrosion, and other causes.

THE LOCOMOTIVE ENGINE.

493. Q.—What is the amount of tractive force requisite to draw carriages on railways?

A.—Upon well formed railways with carriages of good construction, the average tractive force required for low speeds is about $7\frac{1}{2}$ lbs. per ton, or $\frac{1}{300}$ th of the load, though in some experimental cases, where particular care was taken to obtain a favourable result, the tractive force has been reduced as low as $\frac{1}{800}$ th of the load. At low speeds the whole of the tractive force is expended in overcoming the friction, which is made up partly of the friction of attrition in the axles, and partly of the rolling friction, or the obstruction to the rolling of the wheels upon the rail. The rolling friction is very small when the surfaces are smooth, and in the case of railway carriages does not exceed $\frac{1}{1000}$ th of the load; whereas the draught on common roads of good construction, which is chiefly made up of the rolling friction, is as much as $\frac{1}{30}$ th of the load.

494. Q.—In reference to friction you have already stated that the friction of iron sliding upon brass, which has been oiled and then wiped dry, so that no film of oil is interposed, is about $\frac{1}{11}$ th of the pressure, but that in machines in actual operation, where there is a film of oil between the rubbing surfaces, the friction is only about one-third of this amount, or $\frac{1}{33}$ rd of the weight. How then can the tractive resistance

of locomotives at low speeds, which you say is entirely made up of friction, be so little as $\frac{1}{300}$ th of the weight?

A. — I did not state that the resistance to traction was $\frac{1}{300}$ th of the weight upon an average — to which condition the answer given to a previous question must be understood to apply — but I stated that the average traction was about $\frac{1}{300}$ th of the load, which nearly agrees with my former statement. If the total friction be $\frac{1}{300}$ th of the load, and the rolling friction be $\frac{1}{1000}$ th of the load, then the friction of attrition must be $\frac{1}{299}$ th of the load; and if the diameter of the wheels be 36 in., and the diameter of the axles be 3 in., which are common proportions, the friction of attrition must be increased in the proportion of 36 to 3, or 12 times, to represent the friction of the rubbing surface when moving with the velocity of the carriage. $\frac{12}{299}$ ths are about $\frac{1}{25}$ th of the load, which does not differ much from the proportion of $\frac{1}{25}$ rd, as previously determined.

495. Q. — What is the amount of adhesion of the wheels upon the rails?

A. — The adhesion of the wheels upon the rails is about $\frac{1}{4}$ th of the weight when the rails are clean, or either perfectly wet or perfectly dry; but when the rails are half wet or greasy, the adhesion is not more than $\frac{1}{10}$ th or $\frac{1}{12}$ th of the weight or pressure upon the wheels. The weight of a locomotive of modern construction varies from 20 to 25 tons.

496. Q. — And what is its cost and average performance?

A. — The cost of a common narrow gauge loco-

motive, of average power, varies from 1900*l.* to 2200*l.*; it will run on an average 130 miles per day, at a cost for repairs of 2½*d.* per mile; and the cost of locomotive power, including repairs, wages, oil, and coke, does not much exceed 6*d.* per mile run, on economically managed railways. This does not include a sinking fund for the renewal of the engines when worn out, which may be taken as equivalent to 10 per cent. on their original cost.

497. *Q.* — Does the expense of traction increase much with an increased speed?

A. — Yes; it increases very rapidly, partly from the undulation of the earth when a heavy train passes over it at a high velocity, but chiefly from the resistance of the atmosphere and blast pipe, which constitute the greatest of the impediments to motion at high speeds. At a speed of 30 miles an hour, the atmospheric resistance has been found in some cases to amount to about 12 lbs. a ton; and in side winds the resistance even exceeds this amount, partly in consequence of the additional friction caused from the flanges of the wheels being forced against the rails, and partly because the wind catches to a certain extent the front of every carriage, whereby the efficient breadth of each carriage, in giving motion to the air in the direction of the train, is very much increased. At a speed of 30 miles an hour, an engine evaporating 200 cubic feet of water in the hour, and therefore exerting about 200 horses power, will draw a load of 110 tons. Taking the friction of the train at 7½ lbs. per ton, or 825 lbs. operating at the circumference of the driving wheel, — which, with 5 ft. 6 in. wheels, and

18 in. stroke, is equivalent to 4757 lbs. upon the piston, — and taking the resistance of the blast pipe at 6 lbs. per square inch of the pistons, and the friction of the engine unloaded at 1 lb. per square inch, which, with pistons 12 in. in diameter, amount together to 1582 lbs., and reckoning the increased friction of the engine due to the load at $\frac{1}{4}$ th of the load, as in some cases it has been found experimentally to be, though a much less proportion than this would probably be a nearer average, we have 7018·4 lbs. for the total load upon the pistons. At 30 miles an hour the speed of the pistons will be 457·8 feet per minute, and 7018·4 lbs. multiplied by 457·8 ft. per minute, are equal to 3213023·5 lbs. raised one foot high in the minute, which, divided by 33,000, gives 97·3 horses power as the power which would draw 110 tons upon a railway at a speed of 30 miles an hour, if there were no atmospheric resistance. The atmospheric resistance is at the rate of 12 lbs. a ton, with a load of 110 tons, equal to 1320 lbs., moving at a speed of 30 miles an hour, which, when reduced, becomes 105·8 horses power, and this, added to 97·3 makes 203·1, instead of 200 horses power, as ascertained by a reference to the evaporative power of the boiler. This amount of atmospheric resistance, however, exceeds the average, and in some of the experiments for ascertaining the atmospheric resistance, a part of the resistance due to the curves and irregularities of the line has been counted as part of the atmospheric resistance.

498. Q. — Is the resistance per ton of the engine the same as the resistance per ton of the train?

A. — No; it is more, since the engine has not merely

the resistance of the atmosphere and of the wheels to encounter, but the resistance of the machinery besides. According to Mr. Gooch's experiments upon a train weighing 100 tons, the resistance of the engine and tender at 13·1 miles per hour was found by the indicator to be 12·38 lbs ; the resistance per ton of the train, as ascertained by the dynamometer, was at the same speed 7·56 lbs., and the average resistance of locomotive and train was 9·04 lbs. At 20·2 miles per hour these resistances respectively became 19·0, 8·19, and 12·2 lbs. At 44·1 miles per hour the resistances became 34·0, 21·10, and 25·5 lbs., and at 57·4 miles an hour they became 35·5, 17·81, and 23·8 lbs.

499. *Q.* — Is it not maintained that the resistance of the atmosphere to the progress of railway trains increases as the square of the velocity ?

A. — The atmospheric resistance, no doubt, increases as the square of the velocity, and the power, therefore, necessary to overcome it will increase as the cube of the velocity, since in doubling the speed four times, the power must be expended in overcoming the atmospheric resistance in half the time. At low speeds, the resistance does not increase very rapidly ; but at high speeds, as the rapid increase in the atmospheric resistance causes the main resistance to be that arising from the atmosphere, the total resistance will vary nearly as the square of the velocity. Thus the resistance of a train, including locomotive and tender, will, at 15 miles an hour, be about 9·3 lbs. per ton ; at 30 miles an hour it will be 13·2 lbs. per ton ; and at 60 miles an hour 29 lbs. per ton. If we suppose the same law of progression to continue up to 120 miles an hour,

the resistance at that speed will be 92·2 lbs. per ton, and at 240 miles an hour the resistance will be 344·8 lbs. per ton. Thus, in doubling the speed from 60 to 120 miles per hour, the resistance does not fall much short of being increased fourfold, and the same remark applies to the increase of the speed from 120 to 240 miles an hour. These deductions and other deductions from Mr. Gooch's experiments on the resistance of railway trains, are fully discussed by Mr. Clark, in his Treatise on railway machinery, who gives the following rule for ascertaining the resistance of a train, supposing the line to be in good order, and free from curves:—To find the total resistance of the engine, tender, and train in pounds per ton, at any given speed. Square the speed in miles per hour; divide it by 171, and add 8 to the quotient. The result is the total resistance at the rails in lbs. per ton.

500. Q.—How comes it, that the resistance of fluids increases as the square of the velocity, instead of the velocity simply?

A.—Because the height necessary to generate the velocity with which the moving object strikes the fluid, or the fluid strikes the object, increases as the *square* of the velocity, and the resistance or the weight of a column of any fluid varies as the height. A falling body, as has been already explained, to have acquired twice the velocity, must have fallen through four times the height; the velocity generated by a column of any fluid is equal to that acquired by a body falling through the height of the column; and it is therefore clear, that the pressure due to any given velocity must be as the square of that velocity, the

pressure being in every case as twice the altitude of the column. The work done, however, by a stream of air or other fluid in a given time, will vary as the cube of the velocity; for if the velocity of a stream of air be doubled, there will not only be four times the pressure exerted per square foot, but twice the quantity of air will be employed; and in windmills, accordingly, it is found, that the work done varies nearly as the cube of the velocity of the wind. If, however, the work done by *a given quantity* of air moving at different speeds be considered, it will vary as the squares of the speeds.

501. Q.—But in a case where there is no work done, and the resistance varies as the square of the speed, should not the power requisite to overcome that resistance vary as the square of the speed?

A.—It should if you consider the resistance over a given distance, and not the resistance during a given time. Supposing the resistance of a railway train to increase as the square of the speed, it would take four times the power, so far as atmospheric resistance is concerned, to accomplish a mile at the rate of 60 miles an hour, that it would take to accomplish a mile at 30 miles an hour; but in the former case there would be twice the number of miles accomplished in the same time, so that when the velocity of the train was doubled, we should require an engine that was capable of overcoming four times the resistance at twice the speed, or in other words, that was capable of exerting eight times the power, so far as regards the element of atmospheric resistance. We know by experience, however, that it is easier to attain high speeds on rail-

ways than in steam vessels, where the resistance does increase nearly as the square of the speed.

502. Q.—Will you describe generally the arrangement of a locomotive engine?

A.—The boiler and engine are hung upon a framework set on wheels, and, together with this frame or carriage, constitute what is commonly called the locomotive. Behind the locomotive runs another carriage, called the tender, for holding coke and water. A common mode of connecting the engine and tender is by means of a rigid bar, with an eye at each end through which pins are passed. Between the engine and tender, however, buffers should always be interposed, as their pressure contributes greatly to prevent oscillation and other irregular motions of the engine.

503. Q.—How is the framing of a locomotive usually constructed?

A.—All locomotives are now made with the framing which supports the machinery situated within the wheels; but for some years a vehement controversy was maintained respecting the relative merits of outside and inside framing, which has terminated, however, in the universal adoption of the inside framing. It is difficult, in engines intended for the narrow gauge, to get cylinders within the framing of sufficient diameter to meet the exigencies of railway locomotion; by casting both cylinders in a piece, however, a considerable amount of room may be made available to increase their diameters. It is very desirable that the cylinders of locomotives should be as large as possible, so that expansion may be adopted to a large

extent; and with any given speed of piston, the power of an engine either to draw heavy loads, or achieve high velocities, will be increased with every increase of the dimensions of the cylinder. The framing of locomotives, to which the boiler and machinery are attached, and which rests upon the springs situated above the axles, is formed generally of malleable iron, but in some engines the side frames consist of oak with iron plates riveted on each side. The guard plates are in these cases generally of equal length, the frames being curved upwards to pass over the driving axle. Hard cast iron blocks are riveted between the guard plates to serve as guides for the axle bushes. The side frames are connected across at the ends, and cross stays are introduced beneath the boiler to stiffen the frame sideways, and prevent the ends of the connecting or eccentric rods from falling down if they should be broken.

504. Q. — What is the nature and arrangement of the springs of locomotives?

A. — The springs are of the ordinary carriage kind, with plates connected at the centre, and allowed to slide on each other at their ends. The upper plate terminates in two eyes, through each of which passes a pin, which also passes through the jaws of the bridle, connected by a double threaded screw to another bridle, which is jointed to the framing; the centre of the spring rests upon the axle box. Sometimes the springs are placed between the guard plates, and below the framing which rests upon their extremities. One species of spring which has gained a considerable introduction, consists of a number of flat steel plates

with a piece of metal or other substance interposed between them at the centre, leaving the ends standing apart. It would be preferable, perhaps, to make the plates of a common spring with different curves, so that the leaves, though in contact at the centre, would not be in contact at the ends with light loads, but would be brought into contact gradually, as the strain comes on: a spring would thus be obtained that was suitable for all loads.

505. Q. — What is the difference between inside and outside cylinder engines?

A. — Outside cylinders are so designated when placed upon the outside of the framing, with their connecting rods operating upon pins in the driving wheels; while the inside cylinders are situated within the framing, and the connecting rods attach themselves to cranks in the driving axle.

506. Q. — Whether are inside or outside cylinder engines to be preferred?

A. — A diversity of opinion obtains as to the relative merits of outside and inside cylinders. The chief objection to outside cylinders is, that they occasion a sinuous motion in the engine which is apt to send the train off the rails; but this action may be made less perceptible or be remedied altogether, by placing a weight upon one side of the wheels, the momentum of which will just balance the momentum of the piston and its connections. The sinuous or rocking motion of locomotives is traceable to the arrested momentum of the piston and its attachments at every stroke of the engine, and the effect of the pressure thus created will be more operative in inducing oscillation the far-

ther it is exerted from the central line of the engine. If both cylinders were set at right angles in the centre of the carriage, and the pistons were both attached to a central crank, there would be no oscillation produced; or the same effect would be realised by placing one cylinder in the centre of the carriage, and two at the sides — the pistons of the side cylinders moving simultaneously: but it is impossible to couple the piston of an upright cylinder direct to the axle of a locomotive, without causing the springs to work up and down with every stroke of the engine: and the use of three cylinders, though adopted in some of Stephenson's engines, involves too much complication to be a beneficial innovation.

507. Q.—Whether are four-wheeled or six-wheeled engines preferable?

A. — Much controversial ingenuity has been expended upon the question of the relative merits of the four and six-wheeled engines; one party maintaining that four-wheeled engines are most unsafe, and the other that six-wheeled engines are unmechanical, and are more likely to occasion accidents. The four-wheeled engines, however, appear to have been charged with faults that do not really attach to them when properly constructed; for it by no means follows that if the axle of a four-wheeled engine breaks, or even altogether comes away, that the engine must fall down or run off the line; inasmuch as, if the engine be properly coupled with the tender, it has the tender to sustain it. It is obvious enough, that such a connection may be made between the tender and the engine, that either the fore or hind axle of the engine

may be taken away, and yet the engine will not fall down, but will be kept up by the support which the tender affords; and the arguments hitherto paraded against the four-wheeled engines are, so far as regards the question of safety, nothing more than arguments against the existence of the suggested connection. It is no doubt the fact, that locomotive engines are now becoming too heavy to be capable of being borne on four wheels at high speeds without injury to the rails; but the objection of damage to the rails applies with at least equal force to most of the six-wheeled engines hitherto constructed, as in those engines the engineer has the power of putting nearly all the weight upon the driving wheels; and if the rail be wet or greasy, there is a great temptation to increase the bite of those wheels by screwing them down more firmly upon the rails. A greater strain is thus thrown upon the rail than can exist in the case of any equally heavy four-wheeled engine; and the engine is made very unsafe, as a pitching motion will inevitably be induced at high speeds, when an engine is thus poised upon the central driving wheels, and there will also be more of the rocking or sinuous motion. Locomotives, however, intended to achieve high speeds or to draw heavy loads, are now generally made with eight wheels, and in some cases the driving wheels are placed at the end of the engine instead of in the middle.

508. Q.— As the question of the locomotive boiler has been already disposed of in discussing the question of boilers in general, it now only remains to inquire into the subject of the engine, and we may commence

with the cylinders. Will you state the arrangement and construction of the cylinders of a locomotive and their connections?

A.—The cylinders are placed in the same horizontal plane as the axle of the driving wheels, and the connecting rod which is attached to the piston rod engages either a crank in the driving axle or a pin in the driving wheel, according as the cylinders are inside or outside of the framework. The cylinders are generally made an inch longer than the stroke, or there is half an inch of clearance at each end of the cylinder, to permit the springs of the vehicle to act without causing the piston to strike the top or bottom of the cylinder. The thickness of metal of the cylinder ends is usually about a third more than the thickness of the cylinder itself, and both ends are generally made removable. The priming of the boiler, when it occurs, is very injurious to the cylinders and valves of locomotives, especially if the water be sandy, as the grit carried over by the steam wears the rubbing surfaces rapidly away. The face of the cylinder on which the valve works is raised a little above the metal around it, both to facilitate the operation of forming the face and with the view of enabling any foreign substance deposited on the face to be pushed aside by the valve into the less elevated part, where it may lie without occasioning any further disturbance. The valve casing is sometimes cast upon the cylinder, and it is generally covered with a door which may be removed to permit the inspection of the faces. In some valve casings the top as well as the back is removable, which admits of the valve

and valve bridle being removed with greater facility. A cock is placed at each end of locomotive cylinders, to allow the water to be discharged which accumulates in the cylinder from priming or condensation; and the four cocks of the two cylinders are usually connected together, so that by turning a handle the whole are opened at once. In Stephenson's engines, however, with variable expansion, there is but one cock provided for this purpose, which is on the bottom of the valve chest.

509. Q.—What kind of piston is used in locomotives?

A.—The variety of pistons employed in locomotives is very great, and sometimes even the more complicated kinds are found to work very satisfactorily; but, in general, those pistons which consist of a single ring and tongue piece, or of two single rings set one above the other, so as to break joint, are preferable to those which consist of many pieces. In Stephenson's pistons the screws were at one time liable to work slack, and the springs to break.

510. Q.—Will you explain the connection of the piston rod with the connecting rod?

A.—The piston rods of all engines are now generally either case hardened very deeply, or are made of steel; and in locomotive engines the diameter of the piston rod is about one-seventh of the diameter of the cylinder, and it is formed of tilted steel. The cone of the piston rod, by which it is attached to the piston, is turned the reverse way to that which is adopted in common engines, with the view of making the cutter more accessible from the bottom of the cylinder, which

is made to come off like a door. The top of the piston rod is secured with a cutter into a socket with jaws, through the holes of which a cross head passes, which is embraced between the jaws by the small end of the connecting rod, while the ends of the cross head move in guides. Between the piston rod clutch and the guide blocks, the feed pump rod joins the cross head in some engines.

511. Q.—What kind of guides is employed for the end of the piston rod?

A.—The guides are formed of steel plates attached to the framing, between which work the guide blocks, fixed on the ends of the cross head, which have flanges bearing against the inner edges of the guides. Steel or brass guides are better than iron ones: Stephenson and Hawthorn attach their guides at one end to a cross stay, at the other to lugs on the cylinder cover; and they are made stronger in the middle than at the ends. Stout guide rods of steel, encircled by stuffing boxes on the ends of the cross head, would probably be found superior to any other arrangement. The stuffing boxes might contain conical bushes, cut spirally, in addition to the packing, and a ring, cut spirally, might be sprung upon the rod and fixed in advance of the stuffing box, with lateral play to wipe the rod before entering the stuffing box, to prevent it from being scratched by the adhesion of dust.

512. Q.—Is any provision made for keeping the connecting rod always of the same length?

A.—In every kind of locomotive it is very desirable that the length of the connecting rod should remain invariable, in spite of the wear of the brasses, for there

is a danger of the piston striking against the cover of the cylinder if it be shortened, as the clearance is left as small as possible in order to economise steam. In some engines the strap encircling the crank pin is fixed immovably to the connecting rod by dovetailed keys, and a bolt passes through the keys, rod, and strap, to prevent the dovetail keys from working out. The brass is tightened by a gib and cutter, which is kept from working loose by three pinching screws and a cross pin or cutter through the point. The effect of this arrangement is to lengthen the rod, but at the cross head end of the rod the elongation is neutralised by making the strap loose, so that in tightening the brass the rod is shortened by an amount equal to its elongation at the crank pin end. The tightening here is also effected by a gib and cutter, which is kept from working loose by two pinching screws pressing on the side of the cutter. Both journals of the connecting rod are furnished with oil cups, having a small tube in the centre with siphon wicks. The connecting rod is a thick flat bar, with its edges rounded.

513. Q.—How is the cranked axle of locomotives constructed?

A.—The cranked axle of locomotives is always made of wrought iron, with two cranks forged upon it towards the middle of its length, at a distance from each other answerable to the distance between the cylinders. Bosses are made on the axle for the wheels to be keyed upon, and bearings for the support of the framing. The axle is usually forged in two pieces, which are afterwards welded together. Some-

times the pieces for the cranks are put on separately, but the cranks so made are liable to give way. In engines with outside cylinders the axles are made straight—the crank pins being inserted in the naves of the wheels. The bearings to which the connecting rods are attached are made with very large fillets in the corners, so as to strengthen the axle in that part, and to obviate side play in the connecting rod. In engines which have been in use for some time, however, there is generally a good deal of end play in the bearings of the axles themselves, and this slackness contributes to make the oscillation of the engine more violent ; but this evil may be remedied by making the bearings spheroidal, whereby end play becomes impossible.

514. Q.—How are the bearings of the axles arranged ?

A.—The axles bear only against the top of the axle boxes, which are generally of brass ; but a plate extends underneath the bearing, to prevent sand from being thrown upon it. The upper part of the box in most engines has a reservoir of oil, which is supplied to the journal by tubes with siphon wicks. Stephenson uses cast iron axle boxes with brasses, and grease instead of oil ; and the grease is fed upon the journal by the heat of the bearing melting it, whereby it is made to flow down through a hole in the brass. Any engines constructed with outside bearings have inside bearings also, which are supported by longitudinal bars, which serve also in some cases to support the piston guides ; these bearings are sometimes made so as not to touch the axles unless they break.

515. Q.—How are the eccentrics of a locomotive constructed ?

A.—In locomotives the body of the eccentric is of cast iron, in inside cylinder engines the eccentrics are set on the axle between the cranks, and they are put on in two pieces held together by bolts; but in straight axle engines the eccentrics are cast in a piece, and are secured on the shaft by means of a key. The eccentric, when in two pieces, is retained at its proper angle on the shaft by a pinching screw, which is provided with a jam nut to prevent it from working loose. A piece is left out of the eccentric in casting it to allow of the screw being inserted, and the void is afterwards filled by inserting a dovetailed piece of metal. Stephenson and Hawthorn leave holes in their eccentrics on each side of the central arm, and they apply pinching screws in each of these holes. The method of fixing the eccentric to the shaft by a pinching screw is scarcely sufficiently substantial; and cases are perpetually occurring, when this method of attachment is adopted, of eccentrics shifting from their place. In the modern engines the eccentrics are forged on the axles.

516. Q.—How are the eccentric straps constructed?

A.—The eccentric hoops are generally of wrought iron, as brass hoops are found liable to break. When formed of malleable iron, one half of the strap is forged with the rod, the other half being secured to it by bolts, nuts, and jam nuts. Pieces of brass are, in some cases, pinned within the malleable iron hoop; but it appears to be preferable to put brasses within the hoop to encircle the eccentric, as in the case of any

other bearing. When brass straps are used, the lugs have generally nuts on both sides, so that the length of the eccentric rod may be adjusted by their means to the proper length ; but it is better for the lugs of the hoops to abut against the necks of the screws, and, if any adjustment be necessary from the wear of the straps, washers can be interposed. In some engines the adjustment is effected by screwing the valve rod, and the cross head through which it passes has a nut on either side of it, by which its position upon the valve rod is determined.

517. Q. — Will you describe the eccentric rod and valve levers ?

A. — In the engines in use before the introduction of the link motion, the forks of the eccentric rod were of steel, and the length of the eccentric rod was the distance between the centre of the crank axle and the centre of the valve shaft ; but in modern engines the use of the link motion is universal. The valve lever in locomotives is usually longer than the eccentric lever, to increase the travel of the valve, if levers are employed ; but it is better to connect the valve rod to the link of the link motion without the intervention of levers. The pins of the eccentric lever in the old engines used to wear quickly ; Stephenson used to put a ferule of brass on these pins, which being loose, and acting like a roller, facilitated the throwing in and out of gear, and when worn could easily be replaced, so that there was no material derangement of the motion of the valve from play in this situation.

518. Q. — What is the arrangement of a starting lever ?

A.—The starting lever travels between two iron segments, and can be fixed in any desired position. This is done by a small catch or bell crank, jointed to the bottom of the handle at the end of the lever, and coming up by the side of the handle, but pressed out from it by a spring. The smaller arm of this bell crank is jointed to a bolt, which shoots into notches, made in one of the segments between which the lever moves. By pressing the bell crank against the handle of the lever the bolt is withdrawn, and the lever may be shifted to any other point, when, the spring being released, the bolt flies into the nearest notch.

519. *Q.*—In what way does the starting handle act on the machinery of the engine to set it in motion?

A.—Its whole action lies in raising or depressing the link of the link motion relatively with the valve rod. If the valve rod be attached to the middle of the link, the valve will derive no motion from it at all, and the engine will stop. If the attachment be slipped to one end of the link the engine will go ahead, and if slipped to the other end it will go astern. The starting handle merely achieves this change of position.

520. *Q.*—Will you explain the operation of setting the valve of a locomotive?

A.—In setting the valves of locomotives, place the crank in the position answerable to the end of the stroke of the piston, and draw a straight line, representing the centre line of the cylinder, through the centres of the crank shaft and crank pin. From the centre of the shaft describe a circle with the diameter equal to the throw of the valve; another circle to represent the crank shaft; and a third circle to repre-

sent the path of the crank pin. From the centre of the crank shaft, draw a line perpendicular to the centre line of the cylinder and crank shaft, and draw another perpendicular at a distance from the first equal to the amount of the lap and the lead of the valve: the points in which this line intersects the circle of the eccentric are the points in which the centre of the eccentric should be placed for the forward and reverse motions. When the eccentric rod is attached directly to the valve, the radius of the eccentric, which precedes the crank in its revolution, forms with the crank an obtuse angle; but when, by the intervention of levers, the valve has a motion opposed to that of the eccentric rod, the angle contained by the crank and the radius of the eccentric must be acute, and the eccentric must follow the crank: in other words, with a direct attachment to the valve the eccentric is set *more* than one-fourth of a revolution in advance of the crank, and with an indirect attachment the eccentric is set *less* than one-fourth of a circle behind the crank. If the valve were without lap or lead the eccentric would be exactly one-fourth of a circle in advance of the crank or behind the crank, according to the nature of the valve connection; but as the valve would thus cover the port by the amount of the lap and lead, the eccentric must be set forward so as to open the port to the extent of the lap and lead, and this is effected by the plan just described.

521. Q.— In the event of the eccentrics slipping round upon the shaft, which you stated sometimes happens, is it necessary to perform the operation of setting the valve as you have just described it?

A. — If the eccentrics shift upon the shaft, they may be easily refixed by setting the valve open the amount of the lead, setting the crank at the end of the stroke, and bringing round the eccentric upon the shaft till the eccentric rod gears with the valve. It would often be troublesome in practice to get access to the valve for the purpose of setting it, and this may be dispensed with if the amount of lap on the valve and the length of the eccentric rod be known. To this end draw upon a board two straight lines at right angles to one another, and from their point of intersection as a centre describe two circles, one representing the circle of the eccentric, the other the crank shaft; draw a straight line parallel to one of the diameters, and distant from it the amount of the lap and the lead: the points in which this parallel intersects the circle of the eccentric are the positions of the forward and backward eccentrics. Through these points draw straight lines from the centre of the circle, and mark the intersection of these lines with the circle of the crank shaft; measure with a pair of compasses the chord of the arc intercepted between either of these points, and the diameter which is at right angles with the crank, and the diameters being first marked on the shaft itself, then by transferring with the compasses the distance found in the diagram, and marking the point, the eccentric may at any time be adjusted without difficulty.

522. *Q.* — Will you describe the structure and arrangement of the feed pumps of locomotive engines?

A. — The feed pumps of locomotives are generally made of brass, but the plungers are sometimes made

of iron, and are generally attached to the piston cross head, though in Stephenson's engines they are worked by rods attached to eyes on the eccentric hoops. There is a ball valve between the pump and the tender, and two usually in the pipe leading from the pump to the boiler, besides a cock close to the boiler, by which the pump may be shut off from the boiler in case of any accident to the valves. The ball valves are guided by four branches, which rise vertically, and join together at the top in a hemispherical form. The shocks of the ball against this cap have in some cases broken it after one week's work, from the top of the cage having been flat, and the branches not having had their junction at the top properly filleted. These valve guards are attached in different ways to the pipes; when one occurs at the junction of two pieces of pipe it has a flange, which along with the flanges of the pipes and that of the valve seat are held together by a union joint. It is sometimes formed with a thread at the under end, and screwed into the pipe. The balls are cast hollow to lessen the shock, as well as to save the metal. In some cases where the feed pump plunger has been attached to the cross head, the piston rod has been bent by the strain; and that must in all cases occur, if the communication between the pump and boiler be closed when the engine is started, and there be no escape valve for the water.

523. Q.— Are none but ball valves used in the feed pump?

A.— Spindle valves have in some cases been used instead of ball valves, but they are more subject to derangement; but piston valves, so contrived as to

shut a portion of water in the cage when about to close, might be adopted with a great diminution of the sudden shock. In all spindle valves opened and shut rapidly, it is advisable to have the lower surface conical, to take off the shock of the water; and a large lift of the valve should be prevented, else much of the water during the return stroke of the pump will flow out before the valve shuts. Giffard's injectors are now very generally employed to feed boilers, instead of pumps, as stated in the introduction to the present work.

524. Q. — At what part of the boiler is the feed water admitted?

A. — The feed pipe of most locomotive engines enters the boiler near the bottom and about the middle of its length. In Stephenson's engine the water is let in at the smoke box end of the boiler, a little below the water level; by this means the heat is more fully extracted from the escaping smoke, but the arrangement is of questionable applicability to engines of which the steam dome and steam pipe are at the smoke box end, as in that case the entering cold water would condense the steam.

525. Q. — How are the pipes connecting the tender and locomotive constructed, so as to allow of play between the engine and tender without leakage?

A. — The pipes connecting the tender with the pumps should allow access to the valves and free motion to the engine and tender. This end is attained by the use of ball and socket joints; and, to allow some end play, one piece of the pipe slides into the other like a telescope, and is kept tight by means of a

stuffing box. Any pipe joint between the engine and tender must be made in this fashion.

526. Q.—Have you any suggestion to make respecting the arrangement of the feed pump?

A.—It would be a material improvement if a feed pump was to be set in the tender and worked by means of a small engine, such as that now used in steam vessels for feeding the boilers. The present action of the feed pumps of locomotives is precarious, as, if the valves leak in the slightest degree, the steam or boiling water from the boiler will prevent the pumps from drawing. It appears expedient, therefore, that at least one pump should be far from the boiler and should be set among the feed water, so that it will only have to force. If a pump was arranged in the manner suggested, the boiler could still be fed regularly, though the locomotive was standing still.*

527. Q.—Will you explain the construction of locomotive wheels?

A.—The wheels of a locomotive are always made of malleable iron. The driving wheels are made larger to increase the speed; the bearing wheels also are easier on the road when large. In the goods engines the driving wheels are smaller than in the passenger engines, and are generally coupled together. Wheels are made with much variety in their constructive details: sometimes they are made with cast iron naves, with the spokes and rim of wrought iron; but

* Since this recommendation was first given, locomotives have been very frequently fitted with donkey engines, or with Giffard's injectors, and have also been made to carry water and fuel on the locomotive itself.

in the best modern wheels the nave is formed of the ends of the spokes welded together at the centre. When cast iron naves are adopted, the spokes are forged out of flat bars with T-formed heads, and are arranged radially in the founders' mould, the cast iron, when fluid, being poured among them. The ends of the T heads are then welded together to constitute the periphery of the wheel or inner tire; and little wedge-form pieces are inserted where there is any deficiency of iron. In some cases the arms are hollow, though of wrought iron; the tire of wrought iron, and the nave of cast iron; and the spokes are turned where they are fitted into the nave, and are secured in their sockets by means of cutters. Hawthorn makes his wheels with cast iron naves and wrought iron rims and arms; but instead of welding the arms together, he make palms on their outer end, which are attached by rivets to the rim. These rivets, however, unless very carefully formed, are apt to work loose; and it would probably be found an improvement if the palms were to be slightly indented into the rim, in cases in which the palms do not meet each other at the ends. When the rim is turned it is ready for the tire, which is now made of steel.

528. Q. — How do you find the length of bar necessary for forming a tire?

A. — To find the proper length of bar requisite for the formation of a hoop of any given diameter, add the thickness of the bar to the required diameter, and the corresponding circumference in table of circumferences of circles is the length of the bar. If the iron be bent edgewise the breadth of the bar must be

added to the diameter, for it is the thickness of the bar measured radially that is to be taken into consideration. In the tires of railway wheels, which have a flange on one edge, it is necessary to add not only the thickness of the tire, but also two-thirds of the depth of the flange; generally, however, the tire bars are sent from the forge so curved that the plain edge of the tire is concave, and the flange edge convex, while the side which is afterwards to be bent into contact with the cylindrical surface of the wheel is a plane. In this case the addition of the diameter of two-thirds of the depth of the flange is unnecessary, for the curving of the flange edge has the effect of increasing the real length of the bar. When the tire is thus curved, it is only necessary to add the thickness of the hoop to the diameter, and then to find the circumference from a table; or the same result will be obtained by multiplying the diameter thus increased by the thickness of the hoop by 3.1416.

529. Q. — How are the tires attached to the wheels?

A. — The materials for wheel tires are first swaged separately, and then welded together under the heavy hammer at the steel works; after which they are bent to the circle, welded, and turned to certain gauges. The tire is now heated to redness in a circular furnace; during the time it is getting hot, the iron wheel, turned to the right diameter, is bolted down upon a face plate or surface; the tire expands with the heat, and when at a cherry red, it is dropped over the wheel, for which it was previously too small, and it is also hastily bolted down to the surface

plate; the whole mass is then quickly immersed by a swing crane in a tank of water five feet deep, and hauled up and down till nearly cold; the tires are not afterwards tempered. The tire is attached to the rim with rivets having countersunk heads, and the wheel is then fixed on its axle.

530. Q.—Is it necessary to have the whole tire of steel?

A.—It is not indispensable that the whole tire should be of steel; but a dovetail groove, turned out of the tire at the place where it bears most on the rail, and fitted with a band of steel, will suffice. This band may be put in in pieces, and the expedient appears to be the best way of repairing a worn tire; but particular care must be taken to attach these pieces very securely to the tire by rivets, else in the rapid revolution of the wheel the steel may be thrown out by the centrifugal force. In aid of such attachment the steel, after being introduced, is well hammered, which expands it sideways until it fills the dovetail groove.

531. Q.—Is any arrangement adopted to facilitate the passage of the locomotive round curves?

A.—The tire is turned somewhat conical, to facilitate the passage of the engine round curves, — the diameter of the outer wheel being virtually increased by the centrifugal force of the engine, and that of the inner wheel being correspondingly diminished, whereby the curve is passed without the resistance which would otherwise arise from the inequality of the spaces passed over by wheels of the same diameter fixed upon the same axle. The rails.

moreover, are not set quite upright, but are slightly inclined inwards, in consequence of which the wheels must be either conical or slightly dished, to bear fairly upon the rails. One benefit of inclining the rails in this way, and coning the tires, is that the flange of the wheels is less liable to bear against the sides of the rail, and with the same view the flanges of all the wheels are made with large fillets in the corners. Wheels have been placed loose upon the axle, but they have less stability, and are not now much used. Nevertheless this plan appears to be a good one if properly worked out.

582. Q.—Are any precautions taken to prevent engines from being thrown off the rails by obstructions left upon the line?

A.—In most engines a bar is strongly attached to the front of the carriage on each side, and projects perpendicularly downwards to within a short distance of the rail, to clear away stones or other obstructions that might occasion accidents if the engine ran over them.

CHAP. IX.

STEAM NAVIGATION.

RESISTANCE OF VESSELS IN WATER.

533. *Q.*—How do you determine the resistance encountered by a vessel moving in water?

A.—The resistance experienced by vessels moving in water varies as the square of the velocity of their motion, or nearly so; and the power necessary to impart an increased velocity varies nearly as the cube of such increased velocity. To double the velocity of a steam vessel, therefore, will require four times the amount of tractive force, and as that quadrupled force must act through twice the distance in the same time, an engine capable of exerting eight times the original power will be required.*

534. *Q.*—In the case of a board moving in water in the manner of a paddle float, or in the case of

* This statement supposes that there is no difference of level between the water at the bow and the water at the stern. In the experiments on the steamer Pelican, the resistance was found to vary, as the 2.28th power of the velocity, but the deviation from the recognised law was imputed to a difference in the level of the water at the bow and stern.

moving water impinging on a stationary board, what will be the pressure produced by the impact?

A. — The pressure produced upon a flat board, by striking water at right angles to the surface of the board, will be equal to the weight of a column of water having the surface struck as a base, and for its altitude twice the height due to the velocity with which the board moves through the water. If the board strike the water obliquely, the resistance will be less, but no very reliable law has yet been discovered to determine its amount.

535. *Q.* — Will not the resistance of a vessel in moving through the water be much less than that of a flat board of the area of the cross section?

A. — It will be very much less, as is manifest from the comparatively small area of paddle board, and the small area of the circle described by the screw, relatively with the area of the immersed midship section of the vessel. The absolute speed of a vessel, with any given amount of power, will depend very much upon her shape.

536. *Q.* — In what way is it that the shape of a vessel influences her speed, since vessels of the same sectional area must manifestly put in motion a column of water of the same magnitude, and with the same velocity?

A. — A vessel will not strike the water with the same velocity when the bow lines are sharp as when they are otherwise; for a very sharp bow has the effect of enabling the vessel to move through a great distance, while the particles of water are moved aside but a small distance, or in other words, it causes the

velocity with which the water is moved to be very small relatively with the velocity of the vessel; and as the resistance increases as the square of the velocity with which the water is moved, it is conceivable enough in what way a sharp bow may diminish the resistance.

537. *Q.*—Is the whole power expended in the propulsion of a vessel consumed in moving aside the water to enable the vessel to pass?

A.—By no means; only a portion, and in well-formed vessels only a small portion, of the power is thus consumed. In the majority of cases, the greater part of the power is expended in overcoming the friction of the water upon the bottom of the vessel; and the problem chiefly claiming consideration is, in what way we may diminish the friction.

538. *Q.*—Does the resistance produced by this friction increase with the velocity.

A.—It increases nearly as the square of the velocity. At two nautical miles per hour, the thrust necessary to overcome the friction varies as the 1·823 power of the velocity; and at eight nautical miles per hour, the thrust necessary to overcome the friction varies as the 1·713 power of the velocity. It is hardly proper, perhaps, to call this resistance by the name of friction; it is partly, perhaps mainly, due to the viscosity or adhesion of the water.

539. *Q.*—Perhaps at high velocities this resistance may become less?

A.—That appears very probable. It may happen that at high velocities the adhesion is overcome, so that the water is dragged off the vessel, and the

friction thereafter follows the law which obtains in the case of solid bodies. But any such conclusion is mere speculation, since no experiments illustrative of this question have yet been made.

540. Q.—Will a vessel experience more resistance in moving in salt water than in moving in fresh?

A.—If the immersion be the same in both cases a vessel will experience more resistance in moving in salt water than in moving in fresh, on account of the greater density of salt water; but as the flotation is proportionably greater in the salt water the resistance will be the same with the same weight carried.

541. Q.—Discarding for the present the subject of friction, and looking merely to the question of bow and stern resistance, in what manner should the hull of a vessel be formed so as to make these resistances a minimum?

A.—The hull should be so formed that the water, instead of being driven away forcibly from the bow, is opened gradually, so that every particle of water may be moved aside slowly at first, and then faster, like the ball of a pendulum, until it reaches the position of the midship frame, at which point it will have come to a state of rest, and then again, like a returning pendulum, vibrate back in the same way, until it comes to rest at the stern. It is not difficult to describe mechanically the line which the water should pursue. If an endless web of paper be put into uniform motion, and a pendulum carrying a pencil or brush be hung in front of it, then such pendulum will trace on the paper the proper water line of the ship, or the line which the water should pursue in order

that no power may be lost except that which is lost in friction. It is found, however, in practice, that vessels formed with water lines on this principle are not much superior to ordinary vessels in the facility with which they pass through the water; and this points to the conclusion that in ordinary vessels of good form, the amount of power consumed in overcoming the resistance due to the wave at the bow and the partial vacuity at the stern is not so great as has heretofore been supposed, and that, in fact, the main resistance is that due to the friction.

EXPERIMENTS ON THE RESISTANCE OF VESSELS.

542. Q.—Have experiments been made to determine the resistance which steam vessels experience in moving through the water?

A.—Experiments have been made both to determine the relative resistances of different classes of vessels, and also the absolute resistances in pounds or tons. The first experiments made upon this subject were conducted by Messrs. Boulton and Watt, and they have been numerous, long continued, and carefully performed. These experiments were made upon paddle vessels?

543. Q.—Will you recount the chief results of these experiments?

A.—The purpose of the experiments was to establish a coefficient of performance, which with any given class of vessel would enable the speed, which would be obtained with any given power, to be readily

predicted. This coefficient was obtained by multiplying the cube of the velocity of the vessels experimented upon, in miles per hour, by the sectional area of the immersed midship section in square feet, and dividing by the numbers of nominal horses power, and this coefficient will be large in the proportion of the goodness of the shape of the vessel.

544. Q.—How many experiments were made altogether?

A.—There were five different sets of experiments on five different classes of vessels. The first set of experiments was made in 1828, upon the vessels Caledonia, Diana, Eclipse, Kingshead, Moordyke, and Eagle—vessels of a similar form and all with square bilges and flat floors; and the result was to establish the number 925 as the coefficient of performance of such vessels. The second set of experiments was made upon the superior vessels Venus, Swiftsure, Dasher, Arrow, Spitfire, Fury, Albion, Queen, Dart, Hawk, Margaret, and Hero—all vessels having flat floors and round bilges, where the coefficient became 1160. The third set of experiments was made upon the vessels Lightning, Meteor, James Watt, Cinderella, Navy Meteor, Crocodile, Watersprite, Thetis, Dolphin, Wizard, Escape, and Dragon—all vessels with rising floors and round bilges, and the coefficient of performance was found to be 1430. The fourth set of experiments was made in 1834, upon the vessels Magnet, Dart, Eclipse, Flamer, Firefly, Ferret, and Monarch, when the coefficient of performance was found to be 1580. The fifth set of experiments was made upon the Red Rover, City of Canterbury,

Herne, Queen, and Prince of Wales, and in the case of those vessels the coefficient rose to 2550. The velocity of any of these vessels, with any power or sectional area, may be ascertained by multiplying the coefficient of its class by the nominal horse power, dividing by the sectional area in square feet, and extracting the cube root of the quotient, which will be the velocity in miles per hour; or the number of nominal horse power requisite for the accomplishment of any required speed may be ascertained by multiplying the cube of the required velocity in miles per hour, by the sectional area in square feet, and dividing by the coefficient: the quotient is the number of nominal horse power requisite to realise the speed.

545. Q.—Seeing, however, that the nominal power does not represent an invariable amount of dynamical efficiency, would it not be better to make the comparison with reference to the actual power?

A.—In the whole of the experiments recited, except in the case of one or two of the last, the pressure of steam in the boiler varied between $2\frac{3}{4}$ lbs. and 4 lbs. per square inch, and the effective pressure on the piston varied between 11 lbs. and 13 lbs. per square inch, so that the average ratio of the nominal to the actual power may be easily computed; but it will be preferable to state the nominal power of some of the vessels, and their actual power as ascertained by experiment.

546. Q.—Then state this.

A.—Of the Eclipse, the nominal power was 76, and the actual power 144·4 horses; of the Arrow, the nominal power was 60, and the actual 119·5; Spitfire,

nominal 40, actual 64; Fury, nominal 40, actual 65·6; Albion, nominal 80, actual 135·4; Dart, nominal 100, actual 152·4; Hawk, nominal 40, actual 73; Hero, nominal 100, actual 171·4; Meteor, nominal 100, actual 160; James Watt, nominal 120, actual 204; Watersprite, nominal 76, actual 157·6; Dolphin, nominal 140, actual 238; Dragon, nominal 80, actual 131; Magnet, nominal 140, actual 238; Dart, nominal 120, actual 237; Flamer, nominal 120, actual 234; Fire-fly, nominal 52, actual 86·6; Ferret, nominal 52, actual 88; Monarch, nominal 200, actual 378. In the case of swift vessels of modern construction, such as the Red Rover, Herne, Queen, and Prince of Wales, the coefficient appears to be about 2550; but in these vessels there is a still greater excess of the actual over the nominal power than in the case of the vessels previously enumerated, and the increase in the coefficient is consequent upon the increased pressure of the steam in the boiler, as well as the superior form of the ship. The nominal power of the Red Rover, Herne, and City of Canterbury is, in each case, 120 horses, but the actual power of the Red Rover is 294, of the Herne 354, and of the City of Canterbury 306, and in some vessels the excess is still greater; so that with such variations it becomes necessary to adopt a coefficient derived from the introduction of the actual instead of the nominal power.

547. Q.—What will be the average difference between the nominal and actual powers in the several classes of vessels you have mentioned and the respective coefficients when corrected for the actual power?

A.—In the first class of vessels experimented upon, the actual power was about 1·6 times greater than the nominal power; in the second class, 1·67 times greater; in the third class, 1·7 times greater; and in the fourth, 1·96 times greater; while in such vessels as the Red Rover and City of Canterbury, it is 2·65 times greater; so that if we adopt the actual instead of the nominal power in fixing the coefficients, we shall have 554 as the first coefficient, 694 as the second, 832 for the third, and 806 for the fourth, instead of 925, 1160, 1430, and 1580 as previously specified; while for such vessels as the Red Rover, Herne, Queen, and Prince of Wales, we shall have 962 instead of 2550. These smaller coefficients, then, express the relative merits of the different vessels without reference to any difference of efficacy in the engines, and it appears preferable, with such a variable excess of the actual over the nominal power, to employ them instead of those first referred to. From the circumstance of the third of the new coefficients being greater than the fourth, it appears that the superior result in the fourth set of experiments arose altogether from a greater excess of the actual over the nominal power.

548. *Q.* — These experiments, you have already stated, were all made on paddle vessels. Have similar coefficients of performance been obtained in the case of screw vessels?

A. — The coefficients of a great number of screw vessels have been obtained and recorded, but it would occupy too much time to enumerate them here. The coefficient of performance of the Fairy is 464·8; of

the Rattler 676·8 ; and of the Frankfort 792·3. This coefficient, however, refers to nautical and not to statute miles. If reduced to statute miles for the purpose of comparison with the previous experiments, the coefficients will respectively become 703, 1033, and 1212 ; which indicate that the performance of screw vessels is equal to the performance of paddle vessels, but some of the superiority of the result may be imputed to the superior size of the screw vessels.

INFLUENCE OF THE SIZE OF VESSELS UPON THEIR SPEED.

549. *Q.*—Will large vessels attain a greater speed than small, supposing each to be furnished with the same proportionate power ?

A.—It is well known that large vessels furnished with the same proportionate power, will attain a greater speed than small vessels, as appears from the rule usual in yacht races of allowing a certain part of the distance to be run to vessels which are of inferior size. The velocity attained by a large vessel will be greater than the velocity attained by a small vessel of the same mould and the same proportionate power, in the proportion of the square roots of the linear dimensions of the vessels. A vessel therefore with four times the sectional area and four times the power of a smaller symmetrical vessel, and consequently of twice the length, will have its speed increased in the proportion of the square root of 1 to the square root of 2, or 1·4 times.

550. Q.— Will you further illustrate this doctrine by an example?

A.— The screw steamer *Fairy*, if enlarged to three times the size while retaining the same form, would have twenty-seven times the capacity, nine times the sectional area, and nine times the power. The length of such a vessel would be 434 feet; her breadth 63 feet $4\frac{1}{2}$ inches; her draught of water $16\frac{1}{2}$ feet; her area of immersed section 729 square feet; and her nominal power 1080 horses. Now as the lengths of the *Fairy* and of the new vessel are in the proportion of 1 to 3, the speeds will be in the proportion of the square root of 1 to the square root of 3; or, in other words, the speed of the large vessel will be 1.73 times greater than the speed of the small vessel. These deductions, however, are not borne out by the results obtained with the steamer *Great Eastern*, which, with an immersed section of 2000 square feet, and with an actual or indicated power of 8000 horses, attained a speed of only 14 knots, which gives a coefficient of 686, while the coefficient of the *Fairy* is 464.8. As the coefficient is obtained by multiplying the cube of the speed in knots by the immersed section, and dividing by the indicated power, the coefficient of a vessel with 729 sq. ft. section, $22\frac{1}{2}$ knots speed, and 3279 actual horses power would be 2471.

STRUCTURE AND OPERATION OF PADDLE WHEELS.

551. Q.— Will you describe the configuration and mode of action of the paddle wheels in general use?

A.— There are two kinds of paddle wheels in

extensive use, the one being the ordinary radial wheel, in which the floats are fixed on arms radiating from the centre; and the other the feathering wheel, in which each float is hung upon a centre, and is so governed by suitable mechanism as to be always kept in nearly the vertical position. In the radial wheel there is some loss of power from oblique action, whereas in the feathering wheel there is little or no loss from this cause; but in every kind of paddle there is a loss of power from the recession of the water from the float boards, or the *slip* as it is commonly called; and this loss is the necessary condition of the resistance for the propulsion of the vessel being created in a fluid. The slip is expressed by the difference between the speed of the wheel and the speed of the vessel, and the larger this difference is the greater the loss of power from slip must be—the consumption of steam in the engine being proportionate to the velocity of the wheel, and the useful effect being proportionate to the speed of the ship.

552. Q.—The resistance necessary for propulsion will not be situated at the circumference of the wheel?

A.—In the feathering wheel, where every part of any one immersed float moves forward with the same horizontal velocity, the pressure or resistance may be supposed to be concentrated in the centre of the float; whereas, in the common radial wheel this cannot be the case, for as the outer edge of the float moves more rapidly than the edge nearest the centre of the wheel, the outer part of the float is the most effectual in propulsion. The point at which the outer and

inner portions of the float just balance one another in propelling effect, is called the *centre of pressure*; and if all the resistances were concentrated in this point, they would have the same effect as before in resisting the rotation of the wheel. The resistance upon any one moving float board totally immersed in the water will, when the vessel is at rest, obviously vary as the square of its distance from the centre of motion,—the resistance of a fluid varying with the square of the velocity; but, except when the wheel is sunk to the axle or altogether immersed in the water, it is impossible, under ordinary circumstances, for one float to be totally immersed without others being immersed partially, whereby the arc described by the extremity of the paddle arm will become greater than the arc described by the inner edge of the float; and consequently the resistance upon any part of the float will increase in a higher ratio than the square of its distance from the centre of motion — the position of the centre of pressure being at the same correspondingly affected. In the feathering wheel the position of the centre of pressure of the entering and emerging floats is continually changing from the lower edge of the float, — where it is when the float is entering or leaving the water, — to the centre of the float, which is its position when the float is wholly immersed; but in the radial wheel the centre of pressure can never rise so high as the centre of the float.

553. Q.—All this relates to the action of the paddle when the vessel is at rest: will you explain its action when the vessel is in motion?

A.—When the wheel of a coach rolls along the

ground, any point of its periphery describes in the air a curve which is termed a cycloid; any point within the periphery traces a prolate or protracted cycloid, and any point exterior to the periphery traces a curtate or contracted cycloid—the prolate cycloid partaking more of the nature of a straight line, and the curtate cycloid more of the nature of a circle. The action of a paddle wheel in the water resembles in this respect that of wheel of a carriage running along the ground: that point in the radius of the paddle of which the rotative speed is just equal to the velocity of the vessel will describe a cycloid; points nearer the centre, prolate cycloids, and points further from the centre, curtate cycloids. The circle described by the point whose velocity equals the velocity of the ship, is called the *rolling circle*, and the resistance due to the difference of velocity of the rolling circle and centre of pressure is that which operates in the propulsion of the vessel. The resistance upon any part of the float, therefore, will vary as the square of its distance from the rolling circle, supposing the float to be totally immersed; but, taking into account the greater length of time during which the extremity of the paddle acts, whereby the resistance will be made greater, we shall not err far in estimating the resistance upon any point at the third power of its distance from the rolling circle in the case of light immersions, and the 2.5 power in the case of deep immersions.

554. Q.—How is the position of the centre of pressure to be determined?

A.—With the foregoing assumption, which accords

sufficiently with experiment to justify its acceptance, the position of the centre of pressure may be found by the following rule:—from the radius of the wheel subtract the radius of the rolling circle; to the remainder add the depth of the paddle board, and divide the fourth power of the sum by four times the depth; from the cube root of the quotient subtract the difference between the radii of the wheel and rolling circle, and the remainder will be the distance of the centre of pressure from the upper edge of the paddle.

555. Q.—How do you find the diameter of the rolling circle?

A.—The diameter of the rolling circle is very easily found, for we have only to divide 5280 times the number of miles per hour, by 60 times the number of strokes per minute, to get an expression for the circumference of the rolling circle, or the following rule may be adopted:—divide 88 times the speed of the vessel in statute miles per hour, by 3.1416 times the number of strokes per minute; the quotient will be the diameter in feet of the rolling circle. The diameter of the circle in which the centre of pressure moves or the effective diameter of the wheel being known, and also the diameter of the rolling circle, we at once find the excess of velocity of the wheel over the vessel.

556. Q.—Will you illustrate these rules by an example?

A.—A steam vessel of moderately good shape, and with engines of 200 horses power, realises, with 22 strokes per minute, a speed of 10.62 miles per hour.

To find the diameter of the rolling circle, we have 88 times 10.62, equal to 934.66, and 22 times 3.1416, equal to 69.1152; then 934.66 divided by 69.1152 is equal to 13.52 feet, which is the diameter of the rolling circle. The diameter of the wheel is 19 ft. 4 in., so that the diameter of the rolling circle is about $\frac{2}{3}$ of the diameter of the wheel, and this is a frequent proportion. The depth of the paddle board is 2 feet, and the difference between the diameters of the wheel and rolling circle will be 5.8133, which will make the difference of their radii 2.9067; and adding to this the depth of the paddle board, we have 4.9067, the fourth power of which is 579.64, which, divided by four times the depth of the paddle board, gives us 72.455, the cube root of which is 4.1689, which, diminished by the difference of the radii of the wheel and rolling circle, leaves 1.2622 feet for the distance of the centre of pressure from the upper edge of the paddle board in the case of light immersions. The radius of the wheel being 9.6667, the distance from the centre of the wheel to the upper edge of the float is 7.6667, and adding to this 1.2622, we get 8.9299 feet as the radius, or 17.8598 feet as the diameter of the circle in which the centre of pressure revolves. With 22 strokes per minute, the velocity of the centre of pressure will be 20.573 feet per second, and with 10.62 miles per hour for the speed of the vessel, the velocity of the rolling circle will be 15.576 feet per second. The effective velocity will be the difference between these quantities, or 4.997 feet per second. Now the height from which a body must fall by gravity, to acquire a velocity of 4.997 feet per second, is about .62 feet; and

twice this height, or 1.24 feet, multiplied by $62\frac{1}{2}$, which is the number of lbs. weight in a cubic foot of water, gives $77\frac{1}{2}$ lbs. as the pressure on each square foot of the vertical paddle boards. As each board is of 20 square feet of area, and there is a vertical board on each side of the ship, the total pressure on the vertical paddle boards will be 2900 lbs.

557. Q.—What pressure is this equivalent to on each square inch of the pistons?

A.—A vessel of 200 horses power will have two cylinders, each 50 inches diameter, and 5 feet stroke, or thereabout. The area of a piston of 50 inches diameter is 1963.5 square inches, so that the area of the two pistons is 3927 square inches, and the piston will move through 10 feet every revolution; and with 22 strokes per minute, this will be 220 feet per minute, or 3.66 feet per second. Now, if the effective velocity of the centre of pressure and the velocity of the pistons had been the same, then a pressure of 2900 lbs. upon the vertical paddles would have been balanced by an equal pressure on the pistons, which would have been in this case about .75 lbs. per square inch; but as the effective velocity of the centre of pressure is 4.997 feet per second, while that of the pistons is only 3.66 feet per second, the pressure must be increased in the proportion of 4.997 to 3.66 to establish an equilibrium of pressure, or, in other words, it must be 1.02 lbs. per square inch. It follows from this investigation, that, in radial wheels, the greater part of the engine power is distributed among the oblique floats.

558. Q.—How comes this to be the case?

A.— To understand how it happens that more power is expended upon the oblique than upon the vertical floats, it is necessary to remember that the only resistance upon the vertical paddle is that due to the difference of velocity of the wheel and the ship; but if the wheel be supposed to be immersed to its axle, so that the entering float strikes the water horizontally, it is clear that the resistance on such float is that due to the whole velocity of rotation; and that the resistance to the entering float will be the same whether the vessel is in motion or not. The resistance opposed to the rotation of any float increases from the position of the vertical float—where the resistance is that due to the difference of velocity of the wheel and vessel—until it reaches the plane of the axis, supposing the wheel to be immersed so far, where the resistance is that due to the whole velocity of rotation; and although in any oblique float the total resistance cannot be considered operative in a horizontal direction, yet the total resistance increases so rapidly on each side of the vertical float, that the portion of it which is operative in the horizontal direction, is in all ordinary cases of immersion very considerable. In the feathering wheel, where there is little of this oblique action, the resistance will be in the proportion of the square of the horizontal velocities of the several floats, which may be represented by the horizontal distances between them; and in the feathering wheel, the vertical float having the greatest horizontal velocity will have the greatest propelling effect.

559. Q.—Should the floats in feathering wheels enter and leave the water vertically?

A.—The floats should be so governed by the central crank or eccentric, that the entering and emerging floats have a direction intermediate between a radius and a vertical line.

560. Q.—Can you give any practical rules for proportioning paddle wheels?

A.—A common rule for the pitch of the floats is to allow one float for every foot of diameter of the wheel; but in the case of fast vessels a pitch of $2\frac{1}{2}$ feet, or even less, appears preferable, as a close pitch occasions less vibration. If the floats be put too close, however, the water will not escape freely from between them, and if set too far apart the stroke of the entering paddle will occasion an inconvenient amount of vibratory motion, and there will also be some loss of power. To find the proper area of a single float:—divide the number of actual horses power of both engines by the diameter of the wheel in feet; the quotient is the area of one paddle board in square feet proper for sea going vessels, and the area multiplied by 0.6 will give the length of the float in feet. In very sharp vessels, which offer less resistance in passing through the water, the area of paddle board is usually one-fourth less than the above proportion, and the proper length of the float may in such case be found by multiplying the area by 0.7. In sea going vessels about four floats are usually immersed, and in river steamers only one or two floats. There is more slip in the latter case, but there is also more engine power

exerted in the propulsion of the ship, from the greater speed of engine thus rendered possible.

561. Q. — Then is it beneficial to use small floats?

A. — Quite the contrary. If to permit a greater speed of the engine the floats be diminished in area instead of being raised out of the water, no appreciable accession to the speed of the vessel will be obtained; whereas there will be an increased speed of vessel if the accelerated speed of the engine be caused by diminishing the diameter of the wheels. In vessels intended to be very fast, therefore, it is expedient to make the wheels small, so as to enable the engine to work with a high velocity; and it is expedient to make such wheels of the feathering kind, to obviate loss of power from oblique action. In no wheel must the rolling circle fall below the water line, else the entering and emerging floats will carry masses of water before them. The slip is usually equal to about one-fourth of the velocity of the centre of pressure in well proportioned wheels; but it is desirable to have the slip as small as is possible consistently with the observance of other necessary conditions. The speed of the engine and also the speed of the vessel being fixed, the diameter of the rolling circle becomes at once ascertainable, and adding to this the slip, we have the diameter of the wheel.

CONFIGURATION AND ACTION OF THE SCREW.

562. Q. — Will you describe more in detail than you have yet done, the configuration and mode of action of the screw propeller?

A. — The ordinary form of screw propeller is repre-

sented in *figs.* 46. and 47.; *fig.* 46. being a perspective view, and *fig.* 47. an end view, or view such as is

Fig. 46.

Fig. 47.



ORDINARY FORM OF SCREW
PROPELLER.

seen when looking upon the end of the shaft. The screw here represented is one with two arms or blades. Some screws have three arms, some four, and some six; but the screw with two arms is the most usual, and screws with more than three arms are not now much employed in this country. The screw on being put into revolu-

tion by the engine, preserves a spiral path in the water, in which it draws itself forward in the same way as a screw nail does when turned round in a piece of wood, whereas the paddle wheel more resembles the action of a cog wheel working in a rack.

563. Q.—But the screw of a steam vessel has no resemblance to a screw nail?

A.—It has in fact a very close resemblance if you suppose only a very short piece of the screw nail to be employed, and if you suppose, moreover, the thread of the screw to be cut nearly into the centre to prevent the wood from stripping. The original screw propellers were made with several convolutions of screw, but it was found advantageous to shorten them, until they are now only made one-sixth of a convolution in length.

564. Q.—And the pitch you have already explained to be the distance in the line of the shaft from one

convolution to the next, supposing the screw to consist of two or more convolutions?

A.— Yes, that is what is meant by the pitch. If a thread be wound upon a cylinder with an equal distance between the convolutions, it will trace a screw of a uniform pitch; and if the thread be wound upon the cylinder with an increasing distance between each convolution, it will trace a screw of an increasing pitch. But two or more threads may be wound upon the cylinder at the same time, instead of a single thread. If two threads be wound upon it they will trace a double-threaded screw; if three threads be wound upon it they will trace a treble-threaded screw; and so of any other number. Now if the thread be supposed to be raised up into a very deep and thin spiral feather, and the cylinder be supposed to become very small, like the newel of a spiral stair, then a screw will be obtained of the kind proper for propelling vessels, except that only a very short piece of such screw must be employed. Whatever be the number of threads wound upon a cylinder, if the cylinder be cut across all the threads will be cut. A slice cut out of the cylinder will therefore contain a piece of each thread. But the threads, in the case of a screw propeller, answer to the arms, so that in every screw propeller the number of threads entering into the composition of the screw will be the same as the number of arms. An ordinary screw with two blades is a short piece of a screw of two threads.

565. *Q.*— In what part of the ship is the screw usually placed?

A.— In that part of the run of the ship called the

dead wood, which is a thin and unused part of the vessel just in advance of the rudder. The usual arrangement is shown in *fig. 48.*, which represents the

Fig. 48.

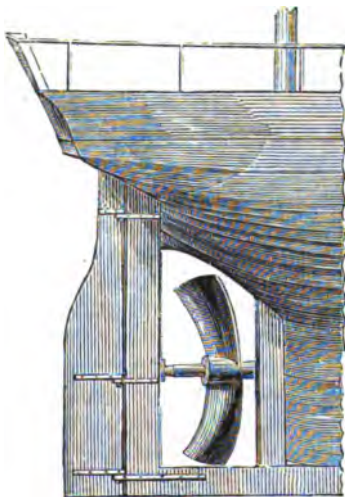

HODGSON'S SCREW PROPELLER.

application to a vessel of a species of screw which has the arms bent backwards, to counteract the centrifugal motion given to the water when there is a considerable amount of slip.

566. Q.— How is the slip in a screw vessel determined?

A.— By comparing the actual speed of the vessel with the speed due to the pitch and number of revo-

lutions of the screw, or, what is the same thing, the speed which the vessel would attain if the screw worked in a solid nut. The difference between the actual speed and this hypothetical speed, is the slip.

567. Q.—In well formed screw propellers what is the amount of slip found to be ?

A.—If the screw be properly proportioned to the resistance that the vessel has to overcome, the slip will not be more than 10 per cent., but in some cases it amounts to 30 per cent., or even more than this. In other cases, however, the slip is nothing at all, and even less than nothing ; or, in other words, the vessel passes through the water with a greater velocity than if the screw were working in a solid nut.

568. Q.—Then it must be by the aid of the wind or some other extraneous force ?

A.—No ; by the action of the screw alone.

569. Q.—But how is such a result possible ?

A.—It appears to be mainly owing to the centrifugal action of the screw, which interposes a film or wedge of water between the screw itself and the water on which the screw reacts. This negative slip, as it is called, chiefly occurs when the pitch of the screw is less than its diameter, and when, consequently, the velocity of rotation is greater than if a coarser pitch had been employed. There is, moreover, in all vessels passing through the water with any considerable velocity, a current of water following the vessel, in which current, in the case of a screw vessel, the screw will revolve ; and in certain cases the phenomenon of negative slip may be imputable in part to the existence of this current.

570. Q.—Is the screw propeller as effectual an instrument of propulsion as the radial or feathering paddle ?

A.—In all cases of deep immersion it appears to be quite as effectual as the radial paddle, indeed, more so ; but it is scarcely as effectual as the feathering paddle, with any amount of immersion, and scarcely as effectual as the common paddle in the case of light immersions.

COMPARATIVE ADVANTAGES OF PADDLE AND SCREW VESSELS.

571. Q.—Whether do you consider paddle or screw vessels to be on the whole the most advantageous ?

A.—That is a large question, and can only receive a qualified answer. In some cases the use of paddles is indispensable, as, for example, in the case of river vessels of a limited draught of water, where it would not be possible to get sufficient depth below the water surface to enable a screw of a proper diameter to be got in.

572. Q.—But how does the matter stand in the case of ocean vessels ?

A.—In the case of ocean vessels, it is found that paddle vessels fitted with the ordinary radial wheels, and screw vessels fitted with the ordinary screw, are about equally efficient in calms and in fair or beam winds with light and medium immersions. If the vessels are loaded deeply, however, as vessels starting on a long voyage and carrying much coal must almost necessarily be, then the screw has an advantage, since

the screw acts in its best manner when deeply immersed, and the paddles in their worst. When a screw and paddle vessel, however, of the same model and power are set to encounter head winds, the paddle vessel it is found has in all cases an advantage, not in speed, but in economy of fuel. For whereas in a paddle vessel, when her progress is resisted, the speed of the engine diminishes nearly in the proportion of the diminished speed of ship, it happens that in a screw vessel this is not so,—at least to an equal extent,—but the engines work with nearly the same rate of speed as if no increase of resistance had been encountered by the ship. It follows from this circumstance, that whereas in paddle vessels the consumption of steam, and therefore of fuel, per hour is materially diminished when head winds occur, in screw vessels a similar diminution in the consumption of steam and fuel does not take place.

573. Q.—But perhaps under such circumstances the speed of the screw vessel will be the greater of the two?

A.—No; the speed of the two vessels will be the same, unless the strength of the head wind be so great as to bring the vessels nearly to a state of rest, and on that supposition the screw vessel will have the advantage. Such cases occur very rarely in practice; and in the case of the ordinary resistances imposed by head winds, the speed of the screw and paddle vessel will be the same, but the screw vessel will consume most coals.

574. Q.—What is the cause of this peculiarity?

A.—The cause is, that when the screw is so pro-

portioned in its length as to be most suitable for propelling vessels in calms, it is too short to be suitable for propelling vessels which encounter a very heavy resistance. It follows, therefore, that if it is prevented from pursuing its spiral course in the water, it will displace the water to a certain extent laterally, in the manner it does if the engine be set on when the vessel is at anchor; and a part of the engine power is thus wasted in producing a useless disturbance of the water, which in paddle vessels is not expended at all.

575. Q.— If a screw and paddle vessel of the same mould and power be tied stern to stern, will not the screw vessel preponderate and tow the paddle vessel astern against the whole force of her engines?

A.— Yes, that will be so.

576. Q.— And seeing that the vessels are of the same mould and power, so that neither can derive an advantage from a variation in that condition, does not the preponderance of the screw vessel show that the screw must be the most powerful propeller?

A.— No, it does not.

577. Q.— Seeing that the vessels are the same in all respects except as regards the propellers, and that one of them exhibits a superiority, does not this circumstance show that one propeller must be more powerful than the other?

A.— That does not follow necessarily, nor is it the fact in this particular case. All steam vessels when set into motion, will force themselves forward with an amount of thrust which, setting aside the loss from friction and from other causes, will just balance the pressure on the pistons. In a paddle vessel, as has

already been explained, it is easy to tell the tractive force exerted at the centre of pressure of the paddle wheels, when, the pressure urging the pistons, the dimensions of the wheels and the speed of the vessel are known; and that force, whatever be its amount, must always continue the same with any constant pressure on the pistons. In a screw vessel the same law applies, so that with any given pressure on the pistons and discarding the consideration of friction, it will follow that whatever be the thrust exerted by a paddle or a screw vessel, it must remain uniform whether the vessel is in motion or at rest, and whether moving at a high or a low velocity through the water. Now to achieve an equal speed during calms in two vessels of the same model, there must be the same amount of propelling thrust in each; and this thrust, whatever be its amount, cannot afterwards vary if a uniform pressure of steam be maintained. The thrusts, therefore, caused by their respective propelling instruments, when a screw and paddle vessel are tied stern to stern, must be the same as at other times; and as at other times those thrusts are equal, so must they be when the vessels are set in the antagonism supposed.

578. Q. — How comes it then that the screw vessel preponderates?

A. — Not by virtue of a larger thrust exerted by the screw in pressing forward the shaft and with it the vessel, but by the gravitation against the stern of the wave of water which the screw raises by its rapid rotation. This wave will only be raised very high when the progress of the vessel through the water is nearly arrested, at which time the centrifugal action

of the screw is very great; and the vessel under such circumstances is forced forward partly by the thrust of the screw, and partly by the hydrostatic pressure of the protuberance of water which the centrifugal action of the screw raises up at the stern.

579. *Q.*— Can you state any facts in corroboration of this view?

A.— The screw vessel will not preponderate if a screw and paddle vessel be tied bow to bow and the engines of each be then reversed. In some screw vessels the amount of thrust actually exerted by the screw under all its varying circumstances, has been ascertained by the application of a dynamometer to the end of the shaft. By this instrument — which is formed by a combination of levers like a weighing machine for carts — a thrust or pressure of several tons can be measured by the application of a small weight; and it has been found, by repeated experiment with the dynamometer, that the thrust of the screw in a screw vessel when towing a paddle vessel against the whole force of her engines, is just the same as it is when the two vessels are maintaining an equal speed in calms. The preponderance of the screw vessel must, therefore, be imputable to some other agency than to a superior thrust of the screw, which is found by experiment not to exist.

580. *Q.*— Has the dynamometer been applied to paddle vessels?

A.— It has not been applied to the vessels themselves, as in the case of screw vessels, but it has been employed on shore to ascertain the amount of tractive force that a paddle vessel can exert on a rope.

581. Q.—Have any experiments been made to determine the comparative performances of screw and paddle vessels at sea?

A.—Yes, numerous experiments; of which the best known are probably those made on the screw steamer *Rattler* and the paddle steamer *Alecto*, each vessel of the same model, size, and power,—each vessel being of about 800 tons burden and 200 horses power. Subsequently another set of experiments with the same object was made with the *Niger* screw steamer and the *Basilisk* paddle steamer, both vessels being of about 1000 tons burden and 400 horses power. The general results which were obtained in the course of these experiments are those which have been already recited.

582. Q.—Will you recapitulate some of the main incidents of these trials?

A.—I may first state some of the chief dimensions of the vessels. The *Rattler* is 176 feet 6 inches long, 32 feet 8½ inches broad, 888 tons burden, 200 horses power, and has an area of immersed midship section of 380 square feet at a draught of water of 11 feet 5½ inches. The *Alecto* is of the same dimensions in every respect, except that she is only of 800 tons burden, the difference in this particular being wholly owing to the *Rattler* having been drawn out about 15 feet at the stern, to leave abundant room for the application of the screw. The *Rattler* was fitted with a dynamometer, which enabled the actual propelling thrust of the screw shaft to be measured; and the amount of this thrust, multiplied by the distance through which the vessel passed in a given time, would determine

the amount of power actually utilised in propelling the ship. Both vessels were fitted with indicators applied to the cylinders, so as to determine the amount of power exerted by the engines.

583. Q.—How many trials of the vessels were made on this occasion?

A.—Twelve trials in all; but I need not refer to those in which similar or identical results were only repeated. The first trial was made under steam only, the weather was calm and the water smooth. At 54 minutes past 4 in the morning both vessels left the Nore, and at 30½ minutes past 2 the Rattler stopped her engines in Yarmouth Roads, where in 20½ minutes afterwards she was joined by the Alecto. The mean speed achieved by the Rattler during this trial was 9·2 knots per hour; the mean speed of the Alecto was 8·8 knots per hour. The slip of the screw was 10·2 per cent. The actual power exerted by the engines, as shown by the indicator, was in the case of the Rattler 334·6 horses, and in the case of the Alecto 281·2 horses; being a difference of 53·4 horses in favour of the Rattler. The forward thrust upon the screw shaft was 3 tons, 17 cwt., 3 qrs., and 14 lbs. The horse power of the shaft—or power actually utilised—ascertained by multiplying the thrust in pounds by the space passed through by the vessel in feet per minute, and dividing by 33,000, was 247·8 horses power. This makes the ratio of the shaft to the engine power as 1 to 1·3, or, in other words, it shows that the amount of engine power utilised in propulsion was 77 per cent. In a subsequent trial made with the vessels running before the wind, but

with no sails set and the masts struck, the speed realised by the Rattler was 10 knots per hour. The slip of the screw was 11·2 per cent. The actual power exerted by the engines of the Rattler was 368·8 horses. The actual power exerted by the engines of the Alecto was 291·7 horses. The thrust of the shaft was equal to a weight of 4 tons, 4 cwt., 1 qr., 1 lb. The horse power of the shaft was 290·2 horses, and the ratio of the shaft to the engine power was 1 to 1·2. Here, therefore, the amount of the engine power utilised was 84 per cent.

584. Q. — If in any screw vessel the power of the engine be diminished by shutting off the steam or otherwise, you will then have a larger screw relatively with the power of the engine than before?

A. — Yes.

585. Q. — Was any experiment made to ascertain the effect of this modification?

A. — There was; but the result was not found to be better than before. The experiment was made by shutting off the steam from the engines of the Rattler, until the number of strokes was reduced to 17 in the minute. The actual power was then 126·7 horses; thrust upon the shaft 2 tons, 2 cwt., 3 qrs., 14 lbs.; horse power of shaft 88·4 horses; ratio of shaft to engine power 1 to 1·4; slip of the screw 18·7 per cent. In this experiment the power utilised was 71 per cent.

586. Q. — Was any experiment made to determine the relative performances in head winds?

A. — The trial in which this relation was best determined lasted for seven hours, and was made

against a strong head wind and heavy head sea. The speed of the Rattler by patent log was 4.2 knots; and at the conclusion of the trial the Alecto had the advantage by about half a mile. Owing to an accidental injury to the indicator, the power exerted by the engines of the Rattler in this trial could not be ascertained; but judging from the power exerted in other experiments with the same number of revolutions, it appears probable that the power actually exerted by the Rattler was about 300 horses. The number of strokes per minute made by the engines of the Rattler was 22, whereas in the Alecto the number of strokes per minute was only 12; so that while the engines of the Alecto were reduced, by the resistance occasioned by a strong head wind, to nearly half their usual speed, the engines of the Rattler were only lessened about one-twelfth of their usual speed. The mean thrust upon the screw shaft during this experiment, was 4 tons, 7 cwt., 0 qr., 16 lbs. The horse power of the shaft was 125.9 horses, and the slip of the screw was 56 per cent. Taking the power actually exerted by the Rattler at 300 horses, the power utilised in this experiment is only 42 per cent.

587. Q.— What are the dimensions of the screw in the Rattler?

A.— Diameter 10 feet, length 1 foot 3 inches, pitch 11 feet. The foregoing experiments show that with a larger screw a better average performance would be obtained. The best result arrived at, was when the vessel was somewhat assisted by the wind, which is equivalent to a reduction of the resistance of

the hull, or to a smaller hull, which is only another expression for a larger proportionate screw.

588. Q. — When you speak of a larger screw, what increase of dimension do you mean to express?

A. — An increase of the diameter. The amount of reacting power of the screw upon the water is not measured by the number of square feet of surface of the arms, but by the area of the disc or circle in which the screw revolves. The diameter of the screw of the Rattler being 10 feet, the area of its disc is 78·5 square feet; and with the amount of thrust already mentioned as existing in the first experiment, viz. 8722 lbs., the reacting pressure on each square foot of the screw's disc will be $108\frac{1}{2}$ lbs. The immersed midship section being 380 square feet, this is equivalent to 23 lbs. per square foot of immersed midship section at a speed of 9·2 knots per hour.

589. Q. — In smaller vessels of similar form, will the resistance per square foot of midship section be more than this?

A. — It will be considerably more. In the Pelican, a vessel of 109 $\frac{1}{2}$ square feet of midship section, I estimate the resistance per square foot of midship section at 30 lbs., when the speed of the vessel is 9·7 knots per hour. In the Minx with an immersed midship section of 82 square feet, the resistance per square foot of immersed midship section was found by the dynamometer to be 41 lbs. at a speed of 8 $\frac{1}{2}$ knots; and in the Dwarf, a vessel with 60 square feet of midship section, I estimate the resistance per square foot of midship section at 46 lbs. at a speed of 9 knots per hour, which is just double the resistance

per square foot of the Rattler. The diameter of the screw of the Minx is $4\frac{1}{2}$ feet, so that the area of its disc is 15.9 square feet, and the area of immersed midship section is about 5 times greater than that of the screw's disc. The diameter of the screw of the Dwarf is 5 feet 8 inches, so that the area of its disc is 25.22 square feet, and the area of immersed midship section is 2.4 times greater than that of the screw's disc. The pressure per square foot of the screw's disc is 214 lbs. in the case of the Minx, and $109\frac{1}{2}$ lbs. in the case of the Dwarf.

590. Q.—From the greater proportionate resistance of small vessels, will not they require larger proportionate screws than large vessels?

A.—They will.

591. Q.—Is there any ready means of predicting what the amount of thrust of a screw will be?

A.—When we know the amount of pressure on the pistons, and the velocity of their motion relatively with the velocity of advance made by the screw, supposing it to work in a solid nut, it is easy to tell what the thrust of the screw would be if it were cleared of the effects of friction and other irregular sources of disturbance. The thrust, in fact, would be at once found by the principle of virtual velocities; and if we take this theoretical thrust and diminish it by one-fourth to compensate for friction and lateral slip, we shall have a near approximation to the amount of thrust that will be actually exerted.*

* See Treatise on the Screw Propeller, by J. Bourne, C.E.

COMPARATIVE ADVANTAGES OF DIFFERENT KINDS OF SCREWS.

592. Q.—What species of screw do you consider the best?

A.—In cases in which a large diameter of screw can be employed, the ordinary screw or helix with two blades seems to be as effective as any other, and it is the most easily constructed. If, however, the screw is restricted in diameter, or if the vessel is required to tow, or will have to encounter habitually strong head winds, it will be preferable to employ a screw with an increasing pitch, and also of such other configuration that it will recover from the water some portion of the power that has been expended in slip.

593. Q.—How can this be done?

A.—There are screws which are intended to accomplish this object already in actual use. When there is much slip a centrifugal velocity is given to the water, and the screw, indeed, if the engine be set on when the vessel is at rest, acts very much as a centrifugal fan would do if placed in the same situation. The water projected outwards by the centrifugal force escapes in the line of least resistance, which is to the surface; and if there be a high column of water over the screw, or, in other words, if the screw is deeply immersed, then the centrifugal action is resisted to a greater extent, and there will be less slip produced. The easiest expedient, therefore, for obviating loss by slip is to sink the screw deeply in the water; but as there are obvious limits to the application of this

remedy, the next best device is to recover and render available for propulsion some part of the power which has been expended in giving motion to the water. One device for doing this consists in placing the screw well forward in the dead wood, so that it shall be overhung by the stern of the ship. The water forced upward by the centrifugal action of the screw will, by impinging on the overhanging stern, press the vessel forward in the water, just in the same way as is done by the wind when acting on an oblique sail. I believe, that two revolving vanes without any twist or obliquity on them at all, would propel a vessel if set well forward in the dead wood or beneath the bottom, merely by the ascent of the water up the inclined plane of the vessel's run; and, at all events, a screw so placed would, in my judgment, aid materially in propelling the vessel when her progress was resisted by head winds.

594. Q. — But you said there are some kinds of screws which profess to accomplish this?

A. — There are screws which profess to counteract the centrifugal velocity given to the water by imparting to it an equal centripetal force, the consequence of which will be, that the water projected backward by the screw, instead of taking the form of the frustrum of a cone, with its small end next the screw, will take the form of a cylinder. One of these forms of screw is that patented by the Earl of Dundonald in 1843, and which is represented in *fig.* 49. Another is the form of screw already represented in *fig.* 48., and which was patented by Mr. Hodgson in 1844. Mr. Hodgson bends the arms of his propellers backward,

not into the form of a triangle, but into the form of a parabola, to the end that the impact of the screw on

Fig. 49.

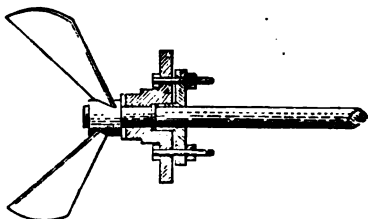

THE EARL OF DUNDONALD'S PROPELLER.

the particles of the water may cause them to converge to a focus, as the rays of light would do in a parabolic reflector. But this particular configuration is not important, seeing that the same convergence which is given to the particles of the water, with a screw of uniform pitch bent back into the form of a parabola, will be given with a screw bent back into the form of a triangle, if the pitch be suitably varied between the centre and the circumference.

595. *Q.*—Then the pitch may be varied in two ways?

A.—Yes: a screw may have a pitch increasing in the direction of the length, as would happen in the case of a spiral stair, if every successive step in the ascent was thicker than the one below it; or it may increase from the centre to the circumference, as would happen in the case of a spiral stair, if every step were thinner at the centre of the tower than at its outer wall. When the pitch of a screw increases

in the direction of its length, the leading edge of the screw enters the water without shock or impact, as the advance of the leading edge per revolution will not be greater than the advance of the vessel. When the pitch of a screw increases in the direction of its diameter, the central part of the screw will advance with only the same velocity as the water, so that it cannot communicate any centrifugal velocity to the water; and the whole slip, as well as the whole propelling pressure, will occur at the outer part of the screw blades.

596. *Q.* — Is there any advantage derived from these forms of screws?

A. — There is a slight advantage, but it is so slight as hardly to balance the increased trouble of manufacture, and, consequently, they are not generally or widely adopted.

597. *Q.* — What other kinds of screw are there proposing to themselves the same or similar objects?

A. — There is the corrugated screw, the arms of which are corrugated, so as it were to gear with the water during its revolution, and thereby prevent it from acquiring a centrifugal velocity. Then there is Griffith's screw, which has a large ball at its centre, which, by the suction it creates at its hinder part, in passing through the water, produces a converging force, which partly counteracts the divergent action of the arms. Finally, there is Holm's screw, which has now been applied to a good number of vessels with success.

598. *Q.* — Will you describe the configuration and action of Holm's screw?

A.—First, then, the screw increases in the direction of its length, and this increase is very rapid at the following edge, so that, in fact, the following edge stands in the plane of the shaft, or in the vertical longitudinal plane of the vessel. Then the ends of the arms are bent over into a curved flange, the edge of which points astern, and the point where this curved flange joins the following edge of the screw is formed, not into an angle, but into a portion of a sphere, so that this corner resembles the bowl of a spoon. When the screw is put into revolution, the water is encountered by the leading edge of the screw without shock, as its advance is only equal to the advance of the vessel, and before the screw leaves the water it is projected directly astern. At the same time, the curved flange at the rim of the screw prevents the dispersion of the water in a radial direction, and it consequently assumes the form of a column or cylinder of water, projected backward from the ship.

599. *Q.*—What is the nature of Beattie's screw?

A.—Beattie's screw is an arrangement of the screw propeller whereby it is projected beyond the rudder, and the main object of the arrangement is to take away the vibratory motion at the stern,—an intention which it accomplishes in practice. There is an oval eye in the rudder, to permit the screw shaft to pass through it, as shown in *fig. 50*.

600. *Q.*—When the diameter of the cylinder of water projected backward by a screw, and the force urging it into motion are known, may not the velocity it will acquire be approximately determined?

A.—That will not be very difficult; and I will take

for illustration the case of the *Minx*, already referred to, which will show how such a computation is to be

Fig. 50.

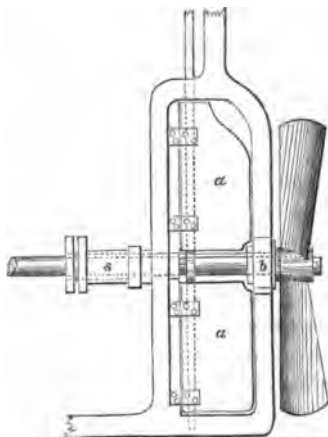

EYE OF RUDDER STOCK.

BEATTIE'S ARRANGEMENT OF SCREW PROPELLER.

a the rudder, *s* the shaft, *b* boss for supporting shaft.

conducted. The speed of this vessel, in one of the experiments made with her, was 8.445 knots; the number of revolutions of the screw per minute, 231.82; and the pressure on each square foot of area of the screw's disc, 214 lbs. If a knot be taken to be 6075.6 feet, then the distance advanced by the vessel, when the speed is 8.445 knots, will be 3.7 feet per revolution, and this advance will be made in about .26 of a second of time. Now the distance which a body will fall by gravity, in .26 of a second, is 1.087 feet; and a weight of 214 lbs. put into motion by gravity, or by a pressure

of 214 lbs., would, therefore, acquire a velocity of 1.087 feet during the time one revolution of the screw is being performed. The weight to be moved, however, is 3.7 cubic feet of water, that being the new water seized by the screw each revolution for every square foot of surface in the screw's disc; and 3.7 cubic feet of water weigh 231.5 lbs., so that the urging force of 214 lbs. is somewhat less than the force of gravity, and the velocity of motion communicated to the water will be somewhat under 1.087 feet per revolution, or we may say it will be in round numbers 1 foot per revolution. This, added to the progress of the vessel, will make the distance advanced by the screw through the water 4.7 feet per revolution, leaving the difference between this and the pitch, namely 1.13 feet, to be accounted for on the supposition that the screw blades had broken laterally through the water to that extent. It would be proper to apply some correction to this computation, which would represent the increased resistance due to the immersion of the screw in the water; for a column of water cannot be moved in the direction of its axis beneath the surface, without giving motion to the superincumbent water, and the inertia of this superincumbent water must, therefore, be taken into the account. In the experiment upon the Minx, the depth of this superincumbent column was but small. The total amount of the slip was 36.53 per cent.; and there will not be much error in setting down about one-half of this as due to the recession of the water in the direction of the vessel's track, and the other half as due to the lateral penetration of the screw blades.

601. Q.— Is it not important to make the stern of screw vessels very fine, with the view of diminishing the slip, and increasing the speed?

A.— It is most important. The Rifleman, a vessel of 486 tons, had originally engines of 200 horses power, which propelled her at a speed of 8 knots an hour. The Teazer, a vessel of 296 tons, had originally engines of 100 horses power, which propelled her at a speed of $6\frac{1}{2}$ knots an hour. The engines of the Teazer were subsequently transferred to the Rifleman, and new engines of 40 horse power were put into the Teazer. Both vessels were simultaneously sharpened at the stern, and the result was, that the 100 horse engines drove the Rifleman, when sharpened, as fast as she had previously been driven by the 200 horse engines; and the 40 horse engines drove the Teazer, when sharpened, a knot an hour faster than she had previously been driven by the 100 horse engines. The immersion of both vessels was kept unchanged in each case; and the 100 horse engines of the Teazer, when transferred to the Rifleman, drove that vessel after she had been sharpened, 2 knots an hour faster than they had previously driven a vessel not much more than half the size. These are important facts for every one to be acquainted with who is interested in the success of screw vessels, and who seeks to obtain the maximum of efficiency with the minimum of expense.*

* See Treatise on the Screw Propeller, by John Bourne, C.E.

PROPORTIONS OF SCREWS.

602. Q.—In fixing upon the proportions of a screw proper to propel any given vessel, how would you proceed?

A.—I would first compute the probable resistance of the vessel, and I would be able to find the relative resistances of the screw and hull, and in every case it is advisable to make the screw as large in diameter as possible. The larger the screw is, the greater will be the efficiency of the engine in propelling the vessel; the larger will be the ratio of the pitch to the diameter, which produces a maximum effect; and the smaller will be the length of the screw or the fraction of a convolution to produce a maximum effect.

603. Q.—Will you illustrate this doctrine by a practical example?

A.—The French screw steamer Pelican was fitted successively with two screws of four blades, but the diameter of the first screw was 98·42 inches, and the diameter of the second 54 inches. If the efficiency of the first screw be represented by 1, that of the second screw will be represented by ·823, or, in other words, if the first screw would give a speed of 10 knots, the second would give little more than 8. The most advantageous ratio of pitch to diameter was found to be 2·2 in the case of the large screw, and 1·384 in the case of the small. The fraction of a convolution which was found to be most advantageous was ·281 in the case of the large screw, and ·450 in the case of the small screw.

604. Q.—Were screws of four blades found to be more efficient than screws with two?

A.—They were found to have less slip, but not to be more efficient, the increased slip in those of two blades being balanced by the increased friction in those of four. Screws of two blades, to secure a maximum efficiency, must have a finer pitch than screws of four.

605. Q.—Are the proportions found to be most suitable in the case of the Pelican applicable to the screws of other vessels?

A.—Only to those which have the same relative resistance of screw and hull. Taking the relative resistance to be the area of immersed midship section, divided by the square of the screw's diameter, it will in the case of the Rattler be $\frac{380}{100}$ or 3·8. From the experiments made by MM. Bourgois and Moll on the screw steamer Pelican, they have deduced the proportions of screws proper for all other classes of vessels, whether the screws are of two, four, or six blades.

606. Q.—Will you specify the nature of their deductions?

A.—I will first enumerate those which bear upon screws with two blades. When the relative resistance is 5·5 the ratio of pitch to diameter should be 1·006, and the fraction of the pitch or proportion of one entire convolution should be 0·454. When the relative resistance is 5, the ratio of pitch to diameter should be 1·069, and fraction of pitch 0·428; relative resistance 4·5, pitch 1·135, fraction 0·402; relative resistance 4, pitch 1·205, fraction 0·378; relative resistance 3·5, pitch 1·279, fraction 0·355; relative

resistance 3, pitch 1·357, fraction 0·334; relative resistance 2·5, pitch 1·450, fraction 0·313; relative resistance 2, pitch 1·560, fraction 0·294; relative resistance 1·5, pitch 1·682, fraction 0·275. The relative resistance of 4 is that which is usual in an auxiliary line of battle ship, 3·5 in an auxiliary frigate, 3 in a high speed line of battle ship, 2·5 in a high speed frigate, 2 in a high speed corvette, and 1·5 in a high speed despatch boat.

607. Q.—What are the corresponding proportions of screws of four blades?

A.—The ratios of the pitches to the diameter being for each of the relative resistances enumerated above, 1·342, 1·425, 1·513, 1·607, 1·705, 1·810, 1·933, 2·080, and 2·243, the respective fractions of pitch or fractions of a whole convolution will be 0·455, 0·428, 0·402, 0·378, 0·355, 0·334, 0·313, 0·294, and 0·275.

608. Q.—And what are the corresponding proportions proper for screws of six blades?

A.—Beginning with the relative resistance of 5·5 as before, the proper ratio of pitch to diameter for that and each of the successive resistances in the case of screws with six blades, will be 1·677, 1·771, 1·891, 1·2009, 2·131, 2·262, 2·416, 2·600, 2·804; and the respective fractions of pitch will be 0·794, 0·749, 0·703, 0·661, 0·621, 0·585, 0·548, 0·515, and 0·481. These are the proportions which will give a maximum performance in every case.*

* In my Treatise on the Screw Propeller I have gone into these various questions more fully than would consort with the limits of this publication.

SCREW VESSELS WITH FULL AND AUXILIARY POWER.

609. Q.—Do you consider that the screw propeller is best adapted for vessels with full power, or for vessels with auxiliary power?

A.—It is, in my opinion, best adapted for vessels with auxiliary power, and it is a worse propeller than paddle wheels for vessels which have habitually to encounter strong head winds. Screw vessels are but ill calculated—at least as constructed heretofore—to encounter head winds, and the legitimate sphere of the screw is in propelling vessels with auxiliary power.

610. Q.—Does the screw act well in conjunction with sails?

A.—I cannot say it acts better than paddles, except in so far as it is less in the way and is less affected by the listing or heeling over of the ship. A small steam power, however, acts very advantageously in aid of sails, for not only does the operation of the sails in reducing the resistance of the hull virtually increase the screw's diameter, but the screw, by reducing the resistance which has to be overcome by the sails and by increasing the speed of the vessel, enables the sails to act with greater efficiency, as the wind will not rebound from them with as great a velocity as it would otherwise do, and a larger proportion of the power of the wind will also be used up. In the case of beam winds, moreover, the action of the screw, by the larger advance it gives to the vessel, will enable the sails to intercept a larger column of wind in a given time. It appears, therefore, that the sails add

to the efficiency of the screw, and that the screw also adds to the efficiency of the sails.

611. Q.—What is the comparative cost of transporting merchandise in paddle steamers of full power, in screw steamers of auxiliary power, and in sailing ships?

A.—That will depend very much upon the locality where the comparison is made. In the case of vessels performing distant ocean voyages, in which they may reckon upon the aid of uniform and constant winds, such as the trade winds or the monsoon, sailing ships of large size will be able to carry more cheaply than any other species of vessel. But where the winds are irregular and there is not much sea room, or for such circumstances as exist in the Channel or Mediterranean trades, screw vessels with auxiliary power will constitute the cheapest instrument of conveyance.

612. Q.—Are there any facts recorded illustrative of the accuracy of this conclusion?

A.—A full paddle vessel of 1000 tons burden and 350 horses power, will carry about 400 tons of cargo, besides coal for a voyage of 500 miles, and the expense of such a voyage, including wear and tear, depreciation, &c., will be about 190*l*. The duration of the voyage will be about 45½ hours. A screw vessel of 400 tons burden and 100 horses power, will carry the same amount of cargo, besides her coals, on the same voyage, and the expense of the voyage, including wear and tear, depreciation, &c., will be not much more than 60*l*. An auxiliary screw vessel, therefore, can carry merchandise at one-third of the cost of a full-powered paddle vessel. By similar comparisons made

between the expense of conveying merchandise in auxiliary screw steamers and sailing ships on coasting voyages, it appears that the cost in the screw steamers is about one-third less than in the sailing ships; the greater expedition of the screw steamers much more than compensating for the expense which the maintenance of the machinery involves.

SCREW AND PADDLES COMBINED.

613. Q. — Would not a screw combined with paddles act in a similarly advantageous way as a screw or paddles when aided by the wind?

A. If in any given paddle vessel a supplementary screw be added to increase her power and speed, the screw will act in a more beneficial manner than if it had the whole vessel to propel itself, and for a like reason the paddles will act in a more beneficial manner. There will be less slip both upon the paddles and upon the screw than if either had been employed alone; but the same object would be attained by giving the vessel larger paddles or a larger screw.

614. Q. — Have any vessels been constructed with combined screw and paddles?

A. — Not any that I know of, except the great vessel built under the direction of Mr. Brunel. The Bee many years since was fitted with both screw and paddles, but this was for the purpose of ascertaining the relative efficiency of the two modes of propulsion, and not for the purpose of using both together.

615. Q. — What would be the best means of ac-

celerating the speed of a paddle vessel by the introduction of a supplementary screw?

A.— If the vessel requires new boilers, the best course of procedure would be to work a single engine giving motion to the screw with high pressure steam, and to let the waste steam from the high pressure engine work the paddle engines. In this way the power might be doubled without any increased expenditure of fuel per hour, and there would be a diminished expenditure per voyage in the proportion of the increased speed.

616. *Q.*— What would the increased speed be by doubling the power?

A.— The increase would be in the proportion of the cube root of 1 to the cube root of 2, or it would be 1.25 times greater. If, therefore, the existing speed were 10 miles, it would be increased to $12\frac{1}{2}$ miles by doubling the power, and the vessel would ply with about a fourth less coals by increasing the power in the manner suggested.

617. *Q.*— Is not high pressure steam dangerous in steam vessels?

A.— Not necessarily so, and it has now been introduced into a good number of steam vessels with satisfactory results. In the case of locomotive engines, where it is used so widely, very few accidents have occurred; and in steam vessels the only additional source of danger is the salting of the boiler. This may be prevented either by the use of fresh water in the boiler, or by practising a larger amount of blowing off, to insure which it should be impossible to diminish the amount of water sent into the boiler

by the feed pump, and the excess should be discharged overboard through a valve near the water level of the boiler, which valve is governed by a float that will rise or fall with the fluctuating level of the water. If the float be a copper ball, a little water should be introduced into it before it is soldered or brazed up, which will ensure an equality of pressure within and without the ball, and a leakage of water into it will then be less likely to take place. A stone float, however, is cheaper, and if properly balanced will be equally effective. All steam vessels should have a large excess of boiling feed water constantly flowing into the boiler, and a large quantity of water constantly blowing off through the surface valves, which being governed by floats will open and let the superfluous water escape whenever the water level rises too high. In this way the boiler will be kept from salting, and priming will be much less likely to occur. The great problem of steam navigation is the economy of fuel, since the quantity of fuel consumed by a vessel will very much determine whether she is profitable or otherwise. Notwithstanding the momentous nature of this condition, however, the consumption of fuel in steam vessels is a point to which very little attention has been paid, and no efficient means have yet been adopted in steam vessels to insure that measure of economy which is known to be attainable, and which has been attained already in other departments of engineering in which the benefits of such economy are of less weighty import. It needs nothing more than the establishment of an efficient system of registration in steam vessels, to insure a large and

rapid economy in the consumption of fuel, as this quality would then become the test of an engineer's proficiency, and would determine the measure of his fame. In the case of the Cornish engines, a saving of more than half the fuel was speedily effected by the introduction of the simple expedient of registration. In agricultural engines a like economy has speedily followed from a like arrangement; yet in both of these cases the benefits of a large saving are less eminent than they would be in the case of steam navigation; and it is to be hoped that this expedient of improvement will now be speedily adopted.

CHAP. X.

EXAMPLES OF ENGINES.

OSCILLATING PADDLE ENGINES.

618. Q.—Will you describe the structure of an oscillating engine as made by Messrs. Penn?

A.—To do this it will be expedient to take an engine of a given power, and then the sizes may be given as well as an account of the configuration of the parts: we may take for an example a pair of engines of $21\frac{1}{2}$ inches diameter of cylinder, and 22 inches stroke, rated by Messrs. Penn at 12 horses power each. The cylinders of this oscillating engine are placed beneath the cranks, and, as in all Messrs. Penn's smaller engines, the piston rod is connected to the crank pin by means of a brass cap, provided with a socket, by means of which it is cuttered to the piston rod. There is but one air pump, which is situated within the condenser between the cylinders, and it is wrought by means of a crank in the intermediate shaft—this crank being cut out of a solid piece of metal as in the formation of the cranked

axles of locomotive engines. The steam enters the cylinder through the outer trunnions, or the trunnions adjacent to the ship's sides, and enters the condenser through the two midship trunnions — a short three ported valve being placed on the front of the cylinder to regulate the flow of steam to and from the cylinder in the proper manner. The weight of this valve on one side of the cylinder is balanced by a weight hung upon the other side of the cylinder; but in the most recent engines this weight is discarded, and two valves are used, which balance one another. The framing consists of an upper and lower frame of cast iron, bound together by eight malleable iron columns: upon the lower frame the pillow blocks rest which carry the cylinder trunnions, and the condenser and the bottom frame are cast in the same piece. The upper frame supports the paddle shaft pillow blocks; and pieces are bolted on in continuation of the upper frame to carry the paddle wheels, which are overhung from the journal.

619. Q. — What are the dimensions and arrangement of the framing?

A. — The web, or base plate, of the lower frame is $\frac{3}{4}$ of an inch thick, and a coaming is carried all round the cylinder, leaving an opening of sufficient size to permit the necessary oscillation. The cross section of the upper frame is that of a hollow beam 6 inches deep, and about $3\frac{1}{2}$ inches wide, with holes at the sides to take out the core; and the thickness of the metal is $\frac{1}{8}$ ths of an inch. Both the upper and the lower frame is cast in a single piece, with the exception of the continuations of the upper frame, which

support the paddle wheels. An oval ring 3 inches wide is formed in the upper frame, of sufficient size to permit the working of the air pump crank; and from this ring feathers run to the ends of the cross portions of the frame which support the intermediate shaft journals. The columns are $1\frac{1}{2}$ inch in diameter; they are provided with collars at the lower ends, which rest upon bosses in the lower frame, and with collars at the upper ends for supporting the upper frame; but the upper collars of two of the corner columns are screwed on, so as to enable the columns to be drawn up when it is required to get the cylinders out. The cross section of the bottom frame is also of the form of a hollow beam, 7 inches deep, except in the region of the condenser, where it is, of course, of a different form. The depth of the boss for the reception of the columns is a little more than 7 inches deep on the lower frame, and a little more than 6 inches deep on the upper frame; and the holes through them are so cored out, that the columns only bear at the upper and lower edges of the hole, instead of all through it — a formation by which the fitting of the columns is facilitated.

620. Q. — What are the dimensions of the condenser?

A. — The condenser, which is cast upon the lower frame, consists of an oval vessel $22\frac{1}{2}$ inches wide, by 2 feet $4\frac{1}{2}$ inches long, and 1 foot $10\frac{1}{2}$ inches deep; it stands 9 inches above the upper face of the bottom frame, the rest projecting beneath it; and it is enlarged at the sides by being carried beneath the trunnions.

621. Q. — What are the dimensions of the air pump?

A. — The air pump, which is set in the centre of the condenser, is $15\frac{1}{4}$ inches in diameter, and has a stroke of 11 inches. The foot valve is situated in the bottom of the air pump, and its seat consists of a disc of brass, in which there is a rectangular flap valve, opening upwards, but rounded on one side to the circle of the pump, and so balanced as to enable the valve to open with facility. The balance weight, which is formed of brass cast in the same piece as the valve itself, operates as a stop, by coming into contact with the disc which constitutes the bottom of the pump; the disc being recessed opposite to the stop to enable the valve to open sufficiently. This disc is bolted to the barrel of the pump by means of an internal flange, and before it can be removed the pump must be lifted out of its place. The air pump barrel is of brass, to which is bolted a cast iron mouth piece, with a port for carrying the water to the hot well; and within the hot well the delivery valve, which consists of a common flap valve, is situated. The mouth piece and the air pump barrel are made tight to the condenser, and to one another, by means of metallic joints carefully scraped to a true surface, so that a little white or red lead interposed makes an air tight joint. The air pump bucket is of brass, and the valve of the bucket is of the common pot lid or spindle kind. The injection water enters through a single cock in front of the condenser — the jet striking against the barrel of the air pump. The air pump rod is maintained in its vertical position by means of guides, the lower

ends of which are bolted to the mouth of the pump, and the upper to the oval in the top frame, within which the air pump crank works; and the motion is communicated from this crank to the pump rod by means of a short connecting rod. The lower frame is not set immediately below the top frame, but $2\frac{1}{2}$ inches behind it, and the air pump and condenser are $2\frac{1}{2}$ inches nearer one edge of the lower frame than the other.

622. Q.—What are the dimensions of the cylinder?

A. — The thickness of the metal of the cylinder is $\frac{9}{16}$ ths of an inch; the depth of the belt of the cylinder is $9\frac{1}{2}$ inches, and its greatest projection from the cylinder is $2\frac{1}{2}$ inches. The distance from the lower edge of the belt to the bottom of the cylinder is $11\frac{1}{2}$ inches, and from the upper edge of the belt to the top flange of the cylinder is 9 inches. The trunnions are $7\frac{1}{2}$ inches diameter in the bearings, and $8\frac{1}{2}$ inches in width; and the flanges to which the glands are attached for screwing in the trunnion packings are $1\frac{1}{2}$ inch thick, and have $\frac{7}{8}$ ths of an inch of projection. The width of the packing space round the trunnions is $\frac{5}{8}$ ths of an inch, and the diameter of the pipe passing through the trunnions $4\frac{5}{8}$ ths, which leaves $\frac{1}{8}$ ths for the thickness of the metal of the bearing. Above and below each trunnion a feather runs from the edge of the belt or bracket between 3 and 4 inches along the cylinder, for the sake of additional support; and in large engines the feather is continued through the interior of the belt, and cruciform feathers are added for the sake of greater stiffness. The projection of the outer face of the trunnion flange from the side

of the cylinder is $6\frac{1}{2}$ inches; the thickness of the flange round the mouth of the cylinder is $\frac{3}{4}$ of an inch, and its projection $1\frac{3}{8}$ inch; the height of the cylinder stuffing box above the cylinder cover is $4\frac{1}{2}$ inches, and its external diameter $4\frac{3}{8}$ inches — the diameter of the piston rod being $2\frac{1}{2}$ inches. The thickness of the stuffing box flange is $1\frac{1}{2}$ inch.

623. Q. — Will you describe the nature of the communication between the cylinder and condenser?

A. — The pipe leading to the condenser from the cylinder is made somewhat bell mouthed where it joins the condenser, and the gland for compressing the packing is made of a larger internal diameter in every part except at the point at which the pipe emerges from it, where it accurately fits the pipe so as to enable the gland to squeeze the packing. By this construction the gland may be drawn back without being jammed upon the enlarged part of the pipe; and the enlargement of the pipe towards the condenser prevents the air pump barrel from offering any impediment to the free egress of the steam. The gland is made altogether in four pieces: the ring which presses the packing is made distinct from the flange to which the bolts are attached which force the gland against the packing, and both ring and flange are made in two pieces, to enable them to be got over the pipe. The ring is half checked in the direction of its depth, and is introduced without any other support to keep the halves together, than what is afforded by the interior of the stuffing box; and the flange is half checked in the direction of its thickness, so that the bolts which press down the ring by passing through

this half-checked part, also keep the segments of the flange together. The bottom of the trunnion packing space is contracted to the diameter of the eduction pipe, so as to prevent the packing from being squeezed into the jacket; but the eduction pipe does not fit quite tight into this contracted part, but, while in close contact on the lower side, has about $\frac{1}{32}$ nd of an inch of space between the top of the pipe and the cylinder, so as to permit the trunnions to wear to that extent without throwing a strain upon the pipe. The eduction pipe is attached to the condenser by a flange joint, and the bolt holes are all made somewhat oblong in the perpendicular direction, so as to permit the pipe to be slightly lowered, should such an operation be rendered necessary by the wear of the trunnion bearings; but in practice the wear of the trunnion bearings is found to be so small, as to be almost inappreciable.

624. — Q. Will you describe the valve and valve casing?

A.—The length of the valve casing is $16\frac{1}{2}$ inches, and its projection from the cylinder is $3\frac{1}{2}$ inches at the top, $4\frac{1}{2}$ inches at the centre, and $2\frac{1}{2}$ inches at the bottom, so that the back of the valve casing is not made flat, but is formed in a curve. The width of the valve casing is 9 inches, but there is a portion of the depth of the belt $1\frac{1}{2}$ inch wider, to permit the steam to enter from the belt into the casing. The valve casing is attached to the cylinder by a metallic joint; the width of the flange of this joint is $1\frac{1}{2}$ inch, the thickness of the flange on the casing $\frac{1}{2}$ inch, and the thickness of the flange on the cylinder $\frac{1}{4}$ ths of an

inch. The projection from the cylinder of the passage for carrying the steam upwards and downwards, from the valve to the top and bottom of the cylinder, is $2\frac{1}{4}$ inches, and its width externally $8\frac{1}{2}$ inches. The valve is of the ordinary three ported description, and both cylinder and valve faces are of cast iron.

625. Q.—What description of piston is used?

A.—The piston is packed with hemp, but the junk ring is made of malleable iron, as cast iron junk rings have been found liable to break : there are four plugs screwed into the cylinder cover, which, when removed, permit a box key to be introduced, to screw down the piston packing. The screws in the junk ring are each provided with a small ratchet, cut in a washer fixed upon the head, to prevent the screw from turning back ; and the number of clicks given by these ratchets, in tightening up the bolts, enables the engineer to know when they have all been tightened equally. In more recent engines, and especially in those of large size, Messrs. Penn employ for the piston packing a single metallic ring with tongue piece and indented plate behind the joint ; and this ring is packed behind with hemp squeezed by the junk ring as in ordinary hemp-packed pistons.

626. Q.—Will you describe the construction of the cap for connecting the piston rod with the crank pin ?

A.—The cap for attaching the piston rod to the crank pin, which is exhibited in perspective in *fig. 51.*, is formed altogether of brass, which brass serves to form the bearing of the crank pin. The external diameter of the socket by which this cap is attached

to the piston rod is $3\frac{5}{8}$ inches. The diameter of the crank pin is 3 inches, and the length of the crank pin bearing $3\frac{7}{8}$ inches. The thickness of the brass around the crank pin bearing is 1 inch, and the upper portion of the brass is secured to the lower portion by means of lugs, which are of such a depth that the perpendicular section through the centre of the bearing has a square outline measuring 7 inches in the horizontal direction, $3\frac{7}{8}$ inches from the centre of the pin to the level of the top of the lugs, and $2\frac{1}{2}$ inches from the centre of the pin to the level of the bottom of the lugs. The width of the lugs is 2 inches, and the bolts passing through them are $1\frac{1}{2}$ inch in diameter. The bolts are tapped into the lower portion of the cap, and are fitted very accurately by scraping where they pass through the upper portion, so as to act as steady pins in preventing the cover of the crank pin bearing from being worked sideways by the alternate thrust on each side. The distance between the centres of the bolts is 5 inches, and in the centre of the cover, where the lugs, continued in the form of a web, meet one another, an oil cup $1\frac{1}{2}$ inch in diameter, $1\frac{1}{2}$ inch high, and provided with an internal pipe, is cast upon the cover, to contain oil for the lubrication of the crank pin bearing. The depth of

Fig. 51.

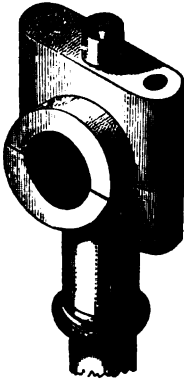

PISTON ROD CAP.
Messrs. Penn.

diameter. The bolts are tapped into the lower portion of the cap, and are fitted very accurately by scraping where they pass through the upper portion, so as to act as steady pins in preventing the cover of the crank pin bearing from being worked sideways by the alternate thrust on each side. The distance between the centres of the bolts is 5 inches, and in the centre of the cover, where the lugs, continued in the form of a web, meet one another, an oil cup $1\frac{1}{2}$ inch in diameter, $1\frac{1}{2}$ inch high, and provided with an internal pipe, is cast upon the cover, to contain oil for the lubrication of the crank pin bearing. The depth of

the cutter for attaching the cap to the piston rod is $1\frac{1}{4}$ inch and its thickness is $\frac{3}{8}$ ths of an inch.

627. Q.—Will you describe the means by which the air pump rod is connected with the crank which works the air pump?

A.—A similar cap to that of the piston rod attaches

Fig. 52.

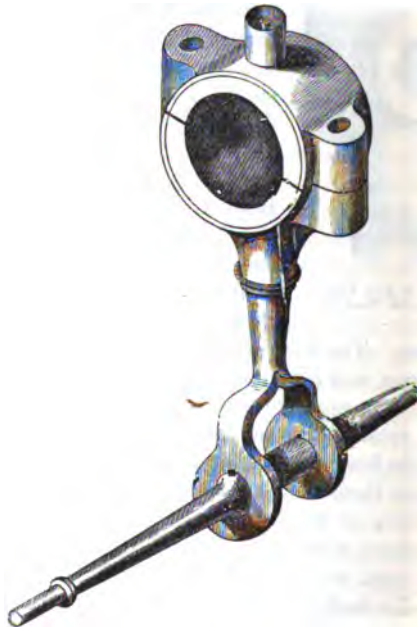

AIR PUMP CONNECTING ROD AND CROSS HEAD. MESSRS. PENN

the air pump crank to the connecting rod by which the air pump rod is moved, but in this instance the diameter of the bearing is 5 inches, and the length of the bearing is about 3 inches. The air pump connecting rod and cross head are shown in perspective in *fig. 52*. The thickness of the brass encircling the bearing of the shaft is three-fourths of an inch upon the edge, and $1\frac{1}{4}$ inch in the centre, the back being slightly rounded; the width of the lugs is $1\frac{1}{2}$ inch, and the depth of the lugs is 2 inches upon the upper brass, and 2 inches upon the lower brass, making a total depth of 4 inches. The diameter of the bolts passing through the lugs is 1 inch, and the bolts are tapped into the lower brass, and accurately fitted into the upper one, so as to act as steady pins, as in the previous instance. The lower eye of the connecting rod is forked, so as to admit the eye of the air pump rod; and the pin which connects the two together is prolonged into a cross head, as shown in *fig. 52*. The ends of this cross head move in guides. The forked end of the connecting rod is fixed upon the cross head by means of a feather, so that the cross head partakes of the motion of the connecting rod, and a cap, similar to that attached to the piston rod, is attached to the air pump rod, for connecting it with the cross head: this cap is shown in *fig. 53*. The diameter of the air pump rod is $1\frac{1}{2}$ inch, the external diameter of the socket encircling the rod is $2\frac{1}{2}$ inches, and the depth of the socket $4\frac{1}{2}$ inches from the centre of the cross head. The depth of the cutter for attaching the socket to the rod is 1 inch, and its thickness $\frac{5}{8}$ inch. The breadth of the lugs is

Fig. 53.

CAP OF AIR PUMP
ROD. Messrs. Penn.

$1\frac{3}{8}$ inch, the depth $1\frac{1}{4}$ inch, making a total depth of $2\frac{1}{2}$ inches; and the diameter of the bolts seven-eighths of an inch. The diameter of the cross head at the centre is 2 inches, the thickness of each jaw around the bearing 1 inch, and the breadth of each $\frac{9}{16}$ inch.

628. Q.—What are the dimensions of the crank shaft and cranks?

A.—The diameter of the intermediate shaft journal is $4\frac{3}{16}$ inches, and of the paddle shaft journal $4\frac{3}{8}$ inches; the length of the journal in each case is 5 inches. The diameter of the large eye of the crank is 7 inches, and the diameter of the hole through it is $4\frac{3}{8}$ inches; the diameter of the small eye of the crank is $5\frac{1}{4}$ inches, the diameter of the hole through it being 3 inches. The depth of the large eye is $4\frac{1}{4}$ inches, and of the small eye $3\frac{3}{4}$ inches; the breadth of the web is 4 inches at the shaft end, and 3 inches at the pin end, and the thickness of the web is $2\frac{5}{8}$ inches. The width of the notch forming the crank in the intermediate shaft for working the air pump is $3\frac{1}{2}$ inches, and the width of each of the arms of this crank is $3\frac{1}{8}$ inches. Both the outer and inner corners of the crank are chamfered away, until the square part of the crank meets the round of the shaft. The method of securing the crank pins into the crank eyes of the intermediate shaft consists in the application of a nut to the end of each pin, where it passes through the eye, the projecting end of the pin being formed with a thread upon which the nut is screwed.

Fig. 54.

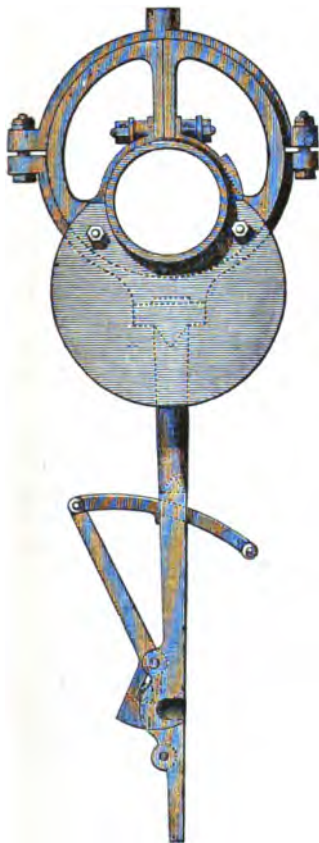

ECCENTRIC AND ROD. Messrs. Penn.

629. Q.—Will you describe the eccentric and eccentric rod ?

A.—The eccentric and eccentric rod are shown in *fig. 54*, The eccentric is put on the crank shaft in two halves, joined in the diameter of largest eccentricity by means of a single bolt passing through lugs on the central eye, and the back balance is made in a separate piece five-eighths of an inch thick, and is attached by means of two bolts, which also help to bind the halves of the eccentric together. The eccentric strap is half an inch thick, and $1\frac{1}{4}$ inch broad, and the flanges of the eccentric, within which the strap works, are each three-eighths of an inch thick. The ec-

centric rod is attached to the eccentric hoop by means of two bolts passing through lugs upon the rod, and tapped into a square boss upon the hoop; and pieces of iron, of a greater or less thickness, are interposed between the surfaces in setting the valve, to make the eccentric rod of the right length. The eccentric rod is kept in gear by the push of a small horizontal rod, attached to a vertical blade spring, and it is thrown out of gear by means of the ordinary disengaging apparatus, which acts in opposition to the spring, as, in cases where the eccentric rod is not vertical, it acts in opposition to the gravity of the rod.

630. *Q.*—Will you explain in detail the construction of the valve gearing, or such parts of it as are peculiar to the oscillating engine?

A.—The eccentric rod is attached by a pin, 1 inch in diameter, to an open curved link or sector with a tail projecting upwards and passing through an eye to guide the link in a vertical motion. This sector, together with the valve lever, shaft, and finger for moving the valve, are represented in *fig. 55*. The link is formed of iron case hardened, and is $2\frac{3}{4}$ inches deep at the middle, and $2\frac{1}{8}$ inches deep at the ends, and 1 inch broad. The opening in the link, which extends nearly its entire length, is $1\frac{5}{8}$ inch broad; and into this opening a brass block 2 inches long is truly fitted, there being a hole through the block $\frac{3}{4}$ inch diameter, for the reception of the pin of the valve shaft lever. The valve shaft is $1\frac{1}{4}$ inch diameter at the end next the link or segment, and diminishes regularly to the other end, but its cross section assumes the form of

an octagon in its passage round the cylinder, measuring mid-way $1\frac{1}{4}$ inch deep, by about $\frac{3}{4}$ inch thick, and the greatest depth of the finger for moving the valve is about 1 inch. The depth of the lever for moving the valve shaft is 2 inches at the broad, and $1\frac{1}{4}$ inch

Fig. 55.

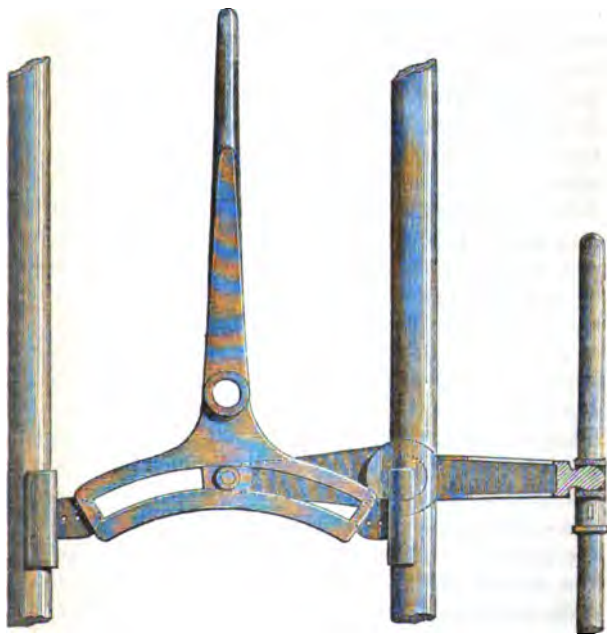

VALVE SECTOR AND SHAFT. Messrs. Penn.

at the narrow end. The internal breadth of the

mortice in which the valve finger moves is $\frac{5}{16}$ inch, and its external depth is $1\frac{3}{4}$ inch, which leaves three-eighths of an inch as the thickness of metal round the hole; and the breadth, measuring in the direction of the hole, is $1\frac{1}{2}$ inch. The valve rod is three-fourths of an inch in diameter, and the mortice is connected to the valve rod by a socket 1 inch long, and $1\frac{1}{8}$ inch diameter, through which a small cutter passes. A continuation of the rod, eleven-sixteenths of an inch diameter, passes upward from the mortice, and works through an eye, which serves the purpose of a guide. In addition to the guide afforded to the segment by the ascending tail, it is guided at the ends upon the columns of the framing by means of thin semi-circular brasses, 4 inches deep, passing round the columns, and attached to the segment by two $\frac{3}{8}$ inch bolts at each end, passing through projecting feathers upon the brasses and segment, three-eighths of an inch in thickness. The curvature of the segment is such as to correspond with the arc swept from the centre of the trunnion to the centre of the valve lever pin when the valve is at half stroke as a radius; and the operation of the segment is to prevent the valve from being affected by the oscillation of the cylinder, but the same action would be obtained by the employment of a smaller eccentric with more lead. In some engines the segment is not formed in a single piece, but of two curved blades, with blocks interposed at the ends, which may be filed down a little, to enable the sides of the slot to be brought nearer, as the metal wears away.

631. Q. — What kind of plummer blocks are used for the paddle shaft bearings?

A. — The paddle shaft plummer blocks are altogether of brass, and are formed in much the same manner as the cap of the piston rod, only that the sole is flat, as in ordinary plummer blocks, and is fitted between projecting lugs of the framing, to prevent side motion. In the bearings fitted on this plan, however, the upper brass will generally acquire a good deal of play after some amount of wear. The bolts are worked slack in the holes, though accurately fitted at first; and it appears expedient, therefore, either to make the bolts very large, and the sockets through which they pass very deep, or to let one brass fit into the other.

632. Q. — How are the trunnion plummer blocks made?

A. — The trunnion plummer blocks are formed in the same manner as the crank shaft plummer blocks; the nuts are kept from turning back by means of a pinching screw passing through a stationary washer. It is not expedient to cast the trunnion plummer blocks upon the lower frame, as is sometimes done; for the cylinders, being pressed from the steam trunnions by the steam, and drawn in the direction of the condenser by the vacuum, have a continual tendency to approach one another; and as they wear slightly towards midships there would be no power of re-adjustment unless the plummer blocks were movable. The flanges of the trunnions should always fit tight against the plummer block sides, but there should be a little play sideways at the necks of the trunnions,

so that the cylinder may be enabled to expand when heated, without throwing an undue strain upon the trunnion supports.

633. Q. — What kind of paddle wheel is supplied with these oscillating engines?

A. — The wheels are of the feathering kind, 9 feet 8 inches in diameter, measuring to the edges of the floats; and there are 10 floats upon each wheel, measuring 4 feet 6 inches long each, and $18\frac{1}{2}$ inches broad. There are two sets of arms to the wheel, which converge to a cast iron centre, formed like a short pipe with large flanges, to which the arms are affixed. The diameter of the shaft, where the centre is put on, is $4\frac{1}{2}$ inches, the external diameter of the pipe is 8 inches, and the diameter of the flanges is 20 inches, and their thickness $1\frac{1}{2}$ inch. The flanges are 12 inches asunder at the outer edge, and they partake of the converging direction of the arms. The arms are $2\frac{1}{4}$ inches broad, and half an inch thick; the heads are made conical, and each is secured into a recess upon the side of the flange by means of three bolts. The ring which connects together the arms, runs round at a distance of 3 feet 6 inches from the centre, and the projecting ends of the arms are bent backward the length of the lever which moves the floats, and are made very wide and strong at the point where they cross the ring, to which they are attached by four rivets. The feathering action of the floats is accomplished by means of a pin fixed to the interior of the paddle box, set 3 inches in advance of the centre of the shaft, and in the same horizontal line. This pin is encircled by a cast iron collar, to

which rods are attached $1\frac{3}{8}$ inch diameter in the centre, proceeding to the levers, 7 inches long, fixed on the back of the floats in the line of the outer arms. One of these rods, however, is formed of nearly the same dimensions as one of the arms of the wheel, and is called the driving arm, as it causes the cast iron collar to turn round with the revolution of the wheel, and this collar, by means of its attachments to the floats, accomplishes the feathering action. The eccentricity in this wheel is not sufficient to keep the floats in the vertical position, but in the position between the vertical and the radial. The diameter of the pins upon which the floats turn is $1\frac{3}{8}$ inch, and between the pins and the paddle ring two stud rods are set between each of the projecting ends of the arms, so as to prevent the two sets of arms from being forced nearer or further apart; and thus prevent the ends of the arms from hindering the action of the floats, by being accidentally jammed upon the sides of the joints. Stays, crossing one another, proceed from the inner flange of the centre to the outer ring of the wheel, and from the outer flange of the centre to the inner ring of the wheel, with the view of obtaining greater stiffness. The floats are formed of plate iron, and the whole of the joints and joint pins are steeled, or formed of steel. For sea going vessels the most approved practice is to make the joint pins of brass, and to bush the eyes of the joints with *lignum vitæ*; and the surface should be large to diminish wear.

634. Q.—Can you give the dimensions of any other oscillating engines?

A.—In Messrs. Penn's 50 horse power oscillating

engine, the diameter of the cylinder is 3 feet 4 inches, and the length of the stroke 3 feet. The thickness of the metal of the cylinder is 1 inch, and the thickness of the cylinder bottom is $1\frac{3}{4}$ inch, crossed with feathers, to give it additional stiffness. The diameter of the trunnion bearings is 1 foot 2 inches, and the breadth of the trunnion bearings $5\frac{1}{2}$ inches. Messrs. Penn, in their larger engines, generally make the area of the steam trunnion less than that of the eduction trunnion, in the proportion of 32 to 37; and the diameter of the eduction trunnion is regulated by the internal diameter of the eduction pipe, which is about $\frac{1}{8}$ th of the diameter of the cylinder. But a somewhat larger proportion than this appears to be expedient: Messrs. Rennie make the area of their eduction pipes, in oscillating engines, $\frac{1}{12}$ nd of the area of the cylinder. In the oscillating engines of the Oberon, by Messrs. Rennie, the cylinder is 61 inches diameter, and $1\frac{1}{2}$ inch thick above and below the belt, but in the wake of the belt it is $1\frac{1}{2}$ inch thick, which is also the thickness of metal of the belt itself. The internal depth of the belt is 2 feet 6 inches, and its internal breadth is 4 inches. The piston rod is $6\frac{3}{4}$ inches in diameter, and the total depth of the cylinder stuffing box is 2 feet 4 inches, of which 18 inches consists of a brass bush — this depth of bearing being employed to prevent the stuffing box or cylinder from wearing oval.

635. Q. — Can you give any other examples?

A. — The diameter of cylinder of the oscillating engines of the steamers Pottinger, Ripon, and Indus, by Miller and Ravenhill, is 76 inches, and the length

of the stroke 7 feet. The thickness of the metal of the cylinder is $1\frac{1}{4}$ inch ; diameter of the piston rod $8\frac{3}{4}$ inches ; total depth of cylinder stuffing box 3 feet ; depth of bush in stuffing box 4 inches ; the rest of the depth, with the exception of the space for packing, being occupied with a very deep gland, bushed with brass. The internal diameter of the steam pipe is 13 inches ; diameter of steam trunnion journal 25 inches ; diameter of eduction trunnion journal 25 inches ; thickness of metal of trunnions $2\frac{1}{2}$ inches ; length of trunnion bearings 11 inches ; projection of cylinder jacket, 8 inches ; depth of packing space in trunnions, 10 inches ; width of packing space in trunnions, or space round the pipes, $1\frac{1}{2}$ inch ; diameter of crank pin $10\frac{1}{2}$ inches ; length of bearing of crank pin $15\frac{1}{2}$ inches. There are six boilers on the tubular plan in each of these vessels ; the length of each boiler is 10 feet 6 inches, and the breadth 8 feet ; and each boiler contains 62 tubes 3 inches in diameter, and 6 feet 6 inches long, and two furnaces 6 feet $4\frac{1}{2}$ inches long, and 3 feet $1\frac{1}{2}$ inch broad.

636. Q. — Is it the invariable practice to make the piston rod cap of brass in the way you have described ?

A. — In all oscillating engines of any considerable size, the cover of the connecting brass, which attaches the crank pin to the connecting rod, is formed of malleable iron ; and the socket also, which is cuttered to the end of the piston rod, is of malleable iron, and is formed with a T head, through which bolts pass up through the brass, to keep the cover of the brass in its place.

637. Q. — Is the piston of an oscillating engine made deeper than in common engines?

A. — It is expedient, in oscillating engines, to form the piston with a projecting rim round the edge above and below, and a corresponding recess in the cylinder cover and cylinder bottom, whereby the breadth of bearing of the solid part of the metal will be increased, and in many engines this is now done.

638. Q. — Would any difficulty be experienced in keeping the trunnions tight in a high pressure oscillating engine?

A. — It is very doubtful whether the steam trunnions of a high pressure oscillating engine will continue long tight if the packing consists of hemp; and it appears preferable to introduce a brass ring, to embrace the pipe, cut spirally, with an overlap piece to cover the cut, and packed behind with hemp.

639. Q. — How is the packing of the trunnions usually effected?

A. — The packing of the trunnions, after being plaited as hard as possible, and cut to the length to form one turn round the pipe, is dipped into boiling tallow, and is then compressed in a mould, consisting of two concentric cylinders, with a gland forced down into the annular space by three to six screws in the case of large diameters, and one central screw in the case of small diameters. Unless the trunnion packings be well compressed, they will be likely to leak air, and it is, therefore, necessary to pay particular attention to this condition. It is also very important that the trunnions be accurately fitted into their brasses by scraping, so that there may not be the

smallest amount of play left upon them ; for if any upward motion is permitted, it will be impossible to prevent the trunnion packings from leaking.

DIRECT ACTING SCREW ENGINE.

640. Q.—Will you describe the configuration and construction of a direct acting screw engine ?

A.—I will take as an example of this species of engine, the engine constructed by Messrs. John Bourne and Co., for the screw steamer *Alma*, a vessel of 500 tons burden. This engine is a single steeple engine laid on its side, and in its general features it resembles the engines of the *Amphion* already described, only that there is one cylinder instead of two. The cylinder is of 42 inches diameter and 42 inches stroke, and the vessel has been propelled by this single engine at the rate of fourteen miles an hour.

641. Q.—Is not a single engine liable to stick upon the centre so that it cannot be started or reversed with facility ?

A.—A single engine is no doubt more liable to stick upon the centre than two engines, the cranks of which are set at right angles with one another ; but numerous paddle vessels are plying successfully that are propelled by a single engine, and the screw offers still greater facility than paddles for such a mode of construction. In the screw engine referred to, as the cylinder is laid upon its side, there is no unbalanced weight to be lifted up every stroke, and the crank, whereby the screw shaft is turned round, consists of two discs with a heavy side intended to balance the

momentum of the piston and its connections ; but these counter-weights by their gravitation also prevent the connecting rod and crank from continuing in the same line when the engine is stopped, and in fact they place the crank in the most advantageous position for starting again when it has to be set on.

642. Q.—Will you explain the general arrangement of the parts of this engine ?

A.—The cylinder lies on its side near one side of the vessel, and from the end of the cylinder two piston rods extend to a cross head sliding athwartships, in guides, near the other side of the vessel. To this cross head the connecting rod is attached, and one end of it partakes of the motion of the cross head or piston, while the other end is free to follow the revolution of the crank on the screw shaft.

643. Q.—What is the advantage of two discs entering into the composition of the crank instead of one ?

A.—A double crank, such as two discs form with the crank pin, is a much steadier combination than would result if only one disc were employed with an over-hung pin. Then the friction on the neck of the shaft is made one half less by being divided between the two bearings, and the short prolongation of the shaft beyond the journal is convenient for the attachment of the eccentrics to work the valves.

644. Q.—Will you enumerate some of the principal dimensions of this engine ?

A.—The bottom frame, on which also the condenser is cast, forms the base of the engine : on one end of it the cylinder is set ; on the other end are the guides

for the cross head, and in the middle are the bearings for the crank shaft. The part where the cylinder stands is two feet high above the engine platform, and the elevation to the centre of the guides or the centre of the shaft is 10 inches higher than this. The metal both of the side frames and bottom flange is $1\frac{1}{2}$ inch thick. The cylinder has flanges cast on its sides, upon which it rests on the bottom frame, and it is sunk between the sides of the frame so as to bring the centre of the cylinder in the same plane as the centre of the screw shaft. The opening left at the guides for the reception of the guide blocks is 6 inches deep, and the breadth of the bearing surface is 11 inches. The cover of the guides is 8 inches deep at the middle, and about half the depth at the ends, and holes are cored through the central web for two oil cups on each guide. The brass for each of the crank shaft bearings is cut into four pieces so that it may be tightened in the up and down direction by the bolts, which secure the plummer block cap, and tightened in the athwartship direction, which is the direction of the strain, by screwing up a wedge-formed plate against the side of the brass, a parallel plate being applied to the other side of the brass, which may be withdrawn to get out the wedge piece when the shaft requires to be lifted out of its place. The air pump is bolted to one side of the bottom frame, and a passage is cast on it conducting from the condenser to the air pump. In this passage the inlet and outlet valves at each end of the air pump are situated, and appropriate doors are formed above them to make them easily accessible. The outlet passage

leading from the air pump communicates with the waste water pipe, through which the water expelled by the air pump is discharged overboard.

645. *Q.*—Is the cylinder of the usual strength and configuration?

A.—The cylinder is formed of cast iron in the usual way, and is $1\frac{1}{8}$ inch thick in the barrel. The ends are of the same thickness, but are each stiffened with six strong feathers. The piston is cast open. The bottom of it is $\frac{5}{8}$ ths of an inch thick, and it is stiffened by six feathers $\frac{3}{4}$ of an inch thick; but the feather connecting the piston rod eyes is $1\frac{1}{4}$ inch thick, and the metal round the eyes is 2 inches thick. The piston is closed by a disc or cover $\frac{5}{8}$ ths of an inch thick, secured by 15 bolts, and this cover answers also the purpose of a junk ring. The piston packing consists of a single cast iron ring $3\frac{1}{2}$ inches broad, and $\frac{1}{2}$ inch thick, packed behind with hemp. This ring is formed with a tongue piece, with an indented plate behind the cut; and the cut is oblique to prevent a ridge forming in the cylinder. The total thickness of the piston is $5\frac{1}{2}$ inches. The piston rods are formed with conical ends for fitting into the piston, but are coned the reverse way as in locomotives, and are secured in the piston by nuts on the ends of the rods, these nuts being provided with ratchets to prevent them from unscrewing accidentally.

646. *Q.*—What species of slide valve is employed?

A.—The ordinary three ported valve, and it is set on the top of the cylinder. The cylinder ports are $4\frac{1}{2}$ inches broad by 24 inches long; and to relieve the valve from the great friction due to the pressure on

so large a surface, a balance piston is placed over the back of the valve, to which it is connected by a strong link; and the upward pressure on this piston being nearly the same as the downward pressure on the valve, it follows that the friction is extinguished, and the valve can be moved with great ease with one hand. The balance piston is 21 inches in diameter. In the original construction of this balance piston two faults were committed. The passage communicating between the condenser and the top of the balance piston was too small, and the pins at the ends of the link connecting the valve and balance piston were formed with an inadequate amount of bearing surface. It followed from this misproportion that the balance piston, being adjusted to take off nearly the whole of the pressure, lifted the valve off the face at the beginning of each stroke. For the escape of the steam into the eduction passage momentarily impaired the vacuum subsisting there, and owing to the smallness of the passage leading to the space above the balance piston, the vacuum subsisting in that space could not be impaired with equal rapidity. The balance piston, therefore, rose by the upward pressure upon it momentarily predominating over the downward pressure on the valve; but this fault was corrected by enlarging the communicating passage between the top of the balance piston and the eduction pipe. The smallness of the pins at the ends of the link connecting the valve and balance piston, caused the surfaces to cut into one another, and to wear very rapidly, and the pins and eyes in this situation should be large in diameter, and as long as they can be got, as they are

not so easily lubricated as the other bearings about the engine, and are moreover kept at a high temperature by the steam. The balance piston is packed in the same way as the main piston of the engine. Its cylinder, which is only a few inches in length, is set on the top of the valve casing, and a trunk projects upwards from its centre to enable the connecting link to rise up in it to attain the necessary length.

Fig. 56.



CONNECTING ROD.
Messrs. Bourne
and Co.

647. Q.—What is the diameter of the piston rods and connecting rod?

A.—The piston rods, which are two in number, are 3 inches diameter, and 12 feet 10 inches long over all. They were, however, found to be rather small, and have since been made half an inch thicker. The connecting rod consists of two rods, which are prolongations of the bolts that connect the sides of the brass bushes which encircle the crank pin and cross head. The connecting rod is shown in perspective in *fig. 56*. The rods composing it are each $2\frac{3}{4}$ inches in diameter.

648. Q.—Will you describe the configuration of the cross head?

A.—The cross head, exhibited in *fig. 57*., is a round piece of iron like a short shaft, with two unequal arms keyed upon it, the longer of which *b* works the air pump, and the shorter *c* works the feed pump. The piston rods enter these arms at *a a*. The cross head is 8 inches diameter

where it is embraced by the connecting rod at *e*, and 7 inches diameter where the air pump and feed pump arms are fixed on. The ends of the cross head *d d*, for a length of 12 inches, are reduced to 3 inches diameter where they fit into round holes in the centre of the guide blocks. Those

Fig. 57.

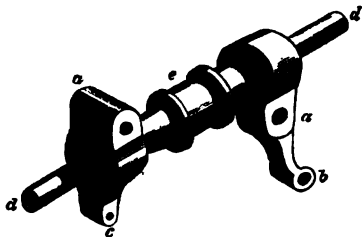

CROSS HEAD AND PUMP ARMS. Messrs. Bourne and Co.

blocks are of cast iron 6 inches deep, 11 inches wide, and 14 inches long, and they are formed with flanges 1 inch thick on the inner sides of the blocks. The projection of the air pump lever from the centre of the cross head is 1 foot 9 inches, and it is bent $5\frac{3}{4}$ inches to one side to enable it to engage the air pump rod. The eye of this arm is 6 inches broad and about 2 inches thick. At the part where one of the piston rods passes through it, the arm is 8 inches deep and 6 inches wide; but the width thereafter narrows to 3 inches, and finally to 2 inches; and the depth of the web of the arm reduces from 8 inches at the piston rod, to 4 inches at the eye, which receives the end

of the air pump rod. The feed pump arm is only 3 inches thick, and has 9 inches of projection from the centre of the cross head; but the eye attached to it on the opposite side of the cross head for the reception of the other piston rod is of the same length as that part of the air pump arm which one of the piston rods passes through. The piston rods have strong nuts on each side of each of these arms to attach them to the arms, and also to enable the length of the piston rods to be suitably adjusted, to leave equal clearance between the piston and each end of the cylinder at the termination of the stroke.

649. Q.—Will you recapitulate the main particulars of the air pump?

A.—The air pump is made of brass $12\frac{1}{2}$ inches diameter and 42 inches stroke, and the metal of the barrel is $\frac{2}{8}$ ths of an inch thick. The air pump bucket is a solid piston of brass, $6\frac{1}{2}$ inches deep at the edge, and 7 inches deep at the eye; and in the edge three grooves are turned to hold water which answers the purpose of packing. The inlet and outlet valves of the air pump consist of brass plates $\frac{1}{2}$ inch with strong feathers across them, and in each plate there are six grated perforations covered by india rubber discs 7 inches in diameter. These six perforations afford collectively an area for the passage of the water equal to the area of the pump. The air pump rod is of brass, $2\frac{1}{2}$ inches diameter.

650. Q.—What are the constructive peculiarities of the discs and crank pin?

A.—The discs, which are 64 inches diameter, are formed of cast iron, and are $2\frac{1}{2}$ inches thick in the

body, and 5 inches broad at the rim. The crank shaft is $8\frac{1}{2}$ inches diameter, and the central boss of the disc which receives the shaft measures 10 inches through the eye, and the metal of the eye is 3 inches thick. In the part of the disc opposite to the crank pin, the web is thickened to 10 inches for nearly the whole semicircle, with the view of making that side of the disc heavier than the other side; and when the engine is stopped, the gravitation of this heavy side raises the crank pin to the highest point it can attain, whereby it is placed in mid stroke, and cannot rest with the piston rods and connecting rod in a horizontal line. The crank pin is $8\frac{1}{2}$ inches diameter, and the length of the bearing or rubbing part of it is 16 inches. It is secured at the ends to the discs by flanges 18 inches diameter, and 2 inches thick. These flanges are indented into thickened parts of the discs, and are each attached to its corresponding disc by six bolts 2 inches diameter, countersunk in the back of the disc, and tapped into the malleable iron flange. Besides this attachment, each end of the pin, reduced to $4\frac{1}{2}$ inches diameter, passes through a hole in its corresponding disc, and the ends of the pin are then riveted over. The crank pin is perforated through the centre by a small hole about $\frac{3}{4}$ of an inch in diameter, and three perforations proceed from this central hole to the surface of the pin. Each crank shaft bearing is similarly perforated, and pipes are cast in the discs connecting these perforations together. The result of this arrangement is, that a large part of the oil or water fed into the bearings of the shaft is driven by the centrifugal action of the discs

442 BOURNE'S DIRECT ACTING SCREW ENGINE.

to the surface of the crank pin, and in this way the crank pin may be oiled or cooled with water in a very effectual manner. To intercept the water or oil which the discs thus drive out by their centrifugal action, a light paddle box or splash board of thin sheet brass

Fig. 58.

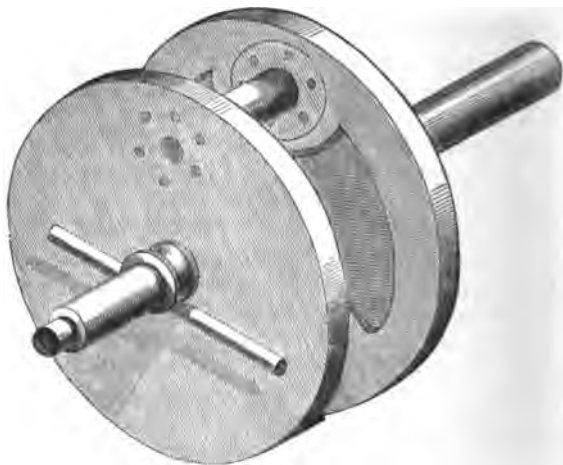

DOUBLE DISC CRANK. Messrs. Bourne and Co.

is made to cover the upper part of each of the discs, and an oil cup with depending wick is supported by the tops of these paddle boxes, which wick is touched at each revolution of the crank by a bridge standing in the middle of an oil cup attached to the crank pin. The oil is wiped from the wick by the projecting

bridge at each revolution, and subsides into the cup from whence it proceeds to lubricate the crank pin bearing. This is the expedient commonly employed to oil the crank pins of direct acting engines; but in the engine now described, there is over and above this expedient, the communicating passages from the shaft bearings to the surface of the pin, by which means any amount of cooling or lubrication can be administered to the crank pin bearing, without the necessity of stopping or slowing the engine.

651. Q.—What is the diameter of the screw shaft?

A.—The screw shaft is $7\frac{1}{2}$ inches diameter, but the bearings on each side of the disc are $8\frac{1}{2}$ inches diameter, and 16 inches long. Between the side of the disc and the side of the contiguous bearing there is a short neck extending $4\frac{1}{2}$ inches in the length of the shaft, and hollowed out somewhat to permit the passage of the piston rod; for one piston rod passes immediately above the shaft on the one side of the discs, and the other piston rod passes immediately below the shaft on the other side of the discs. A short piece of one piston rod is shown in *fig. 58*.

652. Q.—How is the thrust of the screw shaft received?

A.—The thrust of the screw shaft is received upon 7 collars, each 1 inch thick, and with 1 inch of projection above the shaft. The plummer block for receiving the thrust of the shaft is shown in *fig. 59*, and the coupling to enable the screw propeller to be disconnected from the engine, so that it may revolve freely when the vessel is under sail, is shown in *fig. 60*. When it is required to disengage the propeller

444 BOURNE'S DIRECT ACTING SCREW ENGINE.

from the engine, the pins passing through the opposite eyes shown in *fig. 60.*, are withdrawn by means of

Fig. 59.

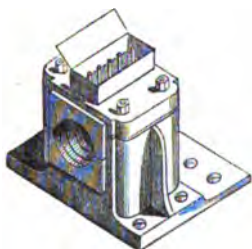

THRUST BEARING.
Messrs. Bourne and Co.

Fig. 60.

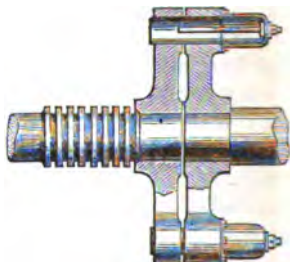

COUPLING CRANKS.
Messrs. Bourne and Co.

screws provided for that purpose, and the propeller and the engine are thenceforth independent of one another.

653. Q.— Will you describe the arrangement of the valve gearing?

A.— The end of the screw shaft, after emerging from the bearing beside the disc, is reduced to a diameter of 4 inches, and is prolonged for $4\frac{1}{2}$ inches to give attachment to the cam or curved plate which gives motion to the expansion valve. This plate is $3\frac{1}{2}$ inches thick, and a stud $3\frac{1}{2}$ inches diameter is fixed in the plate at a distance of 5 inches from the centre of the shaft. To this stud an arm is attached which extends to a distance of 2 inches from the centre of the shaft in the opposite direction, and the end of this arm carries a pin of $2\frac{1}{2}$ inches diameter. From the

pin most remote from the centre of the shaft, a rod $2\frac{1}{2}$ inches broad and 1 inch thick extends to the upper end of the link of the link motion; and from the pin

Fig. 61.

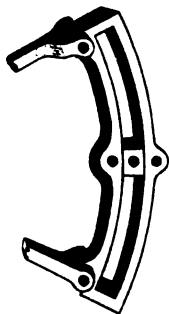

LINK MOTION.

Messrs. Bourne and Co.

least remote from the centre of the shaft, a similar rod extends to the lower end of the link of the link motion. This link, which is represented in *fig. 61.*, is $2\frac{1}{2}$ inches broad, 1 inch thick, and is capable of being raised or lowered 25 inches in all. In the open part of the link is a brass block, which, by raising or lowering the link, takes either the position in which it is represented at the centre of the link, or a position at either end of it. Through the hole in the brass block a pin passes to attach the brass to the end of a lever fixed on the valve shaft; so that whatever motion is imparted to the brass block is communicated to the valve through the medium of this lever. If the brass block be set in the middle of the link, no motion is communicated to it, and the valve being consequently kept stationary and covering both ports, the engine stops. If the link be lowered until the brass block comes to the upper end of the link, the valve receives the motion of the eccentric for going ahead, and the engine moves ahead; whereas if the link be raised until the brass block comes to the lower end of the link, the valve receives the motion of the backing eccentric, and the engine moves astern. Instead of eccentrics, however, pins at the end of the

shaft are employed in this engine, the arrangement partaking of the nature of a double crank; but the backing pin has less throw than the going ahead pin, whereby the efficient length of the link for going ahead is increased; and the operation of backing, which does not require to be performed at the highest rate of speed, is sufficiently accommodated by about half the throw being given to the valve that is given in going ahead. A valve shaft extends across the end of the cylinder with two levers standing up, which engage horizontal side rods extending from a small cross head on the end of the valve rod. A lever extends downwards from the end of the valve shaft, which is connected by a pin to the brass block within the link; and the link is moved up or down by the starting handle, which, by means of a spring bolt shooting into a quadrant, holds the starting handle at any position in which it may be set.

654. Q. — What is the diameter and pitch of the screw propeller?

A. — The diameter is 7 feet and the pitch 14 feet. The propeller is Holm's conchoidal propeller. Its diameter is smaller than is advisable, being limited by the draught of water of the vessel; and the vessel was required to have a small draught of water to go over a bar. This engine makes, under favourable circumstances, 100 strokes per minute. The speed of piston with this number of strokes is 700 feet per minute, and the engine works steadily at this speed, the shock and tremor arising from the arrested momentum of the moving parts being taken away by the counterbalance applied at the discs.

LOCOMOTIVE ENGINE.

655. Q.— Will you describe the principal features of a modern locomotive engine?

A.— I will take for this purpose the locomotive Snake, constructed by John V. Gooch for the London and South Western Railway, as an example of a modern locomotive of good construction, adapted for the narrow gauge. The length of the wheel base of this engine is 12 feet $8\frac{1}{2}$ inches. There are two cylinders, each $14\frac{1}{4}$ inches diameter and 21 inches stroke. The total weight of the engine is 19 tons; and this weight is so distributed on the wheels as to throw 8 tons on the leading wheels, 6 tons on the driving wheels, and 5 tons on the hind wheels. The engine is made with outside cylinders, and the cylinders are raised somewhat out of the horizontal line to enable them better to clear the leading wheels.

656. Q.— What are the dimensions of the boiler?

A.— The interior of the fire box is 3 feet $7\frac{1}{4}$ inches wide by 3 feet $5\frac{1}{2}$ inches long, measuring in the direction of the rails. The area of the fire grate is consequently 12·4 square feet. The bars are somewhat lower on the side next the fire door than at the side next the tubes, and the mean height of the crown of the fire box above the bars is 3 feet 10 inches. The top edge of the fire door is about 7 inches lower than the crown of the fire box. The fire box is divided transversely by a corrugated feather or bridge of plate iron, containing water, about $3\frac{1}{2}$ inches wide, and of about one-third of the height of the fire box in the centre of the feather, and about two-thirds the height

of the fire box at the sides where it joins the sides of the fire box. The internal shell of the fire box tapers somewhat upwards to facilitate the disengagement of the steam. It is about 2 inches narrower and shorter at the top than at the bottom; the water space between the external and internal shell of the fire box being 2 inches at the bottom and 3 inches at the top.

657. Q. — Of what material is the fire box composed?

A. — The external shell of the fire box is formed of iron plates $\frac{3}{8}$ ths of an inch thick, and the internal shell is formed of copper plates $\frac{1}{2}$ inch thick, but the tube plate is $\frac{3}{4}$ inch thick. The fire grate is rectangular, and the internal and external shells are tied together by iron stay bolts $\frac{3}{4}$ inch diameter, and pitched about 4 inches apart. The roof of the fire box is stiffened by six strong bars extending from side to side of the fire box like beams, and the top of the fire box is secured to these bars, so that it cannot be forced down without breaking or bending them.

658. Q. — What are the dimensions of the barrel of the boiler?

A. — The barrel of the boiler is 3 feet $7\frac{1}{2}$ inches in diameter, and 10 feet long. It is formed of iron plates $\frac{3}{8}$ ths of an inch thick, riveted together. It is furnished with 181 brass tubes $1\frac{1}{8}$ inch diameter and 10 feet long, secured at the ends by ferules. The tube plate at the smoke box end is $\frac{5}{8}$ ths of an inch thick, and the tube plates above the tubes are tied together by eight iron rods $\frac{7}{8}$ ths of an inch thick, extending from end to end of the boiler. The metal of the tubes is somewhat thicker at the end next the fire, being 13 wire gauge

at fire box end, and 14 wire gauge at smoke box end. The rivets of the boiler are $\frac{3}{4}$ inch diameter and $1\frac{1}{2}$ inch pitch. The plating of the ash pan is $\frac{5}{16}$ ths of an inch thick, and the plating of the smoke box is $\frac{3}{8}$ ths of an inch thick.

659. Q. — Will you describe the structure of the framework on which the boiler and its attachments rest, and in which the wheels are set?

A. — The framework or framing consists of a rectangular structure of plate iron circumscribing the boiler, with projecting lugs or arms for the reception of the axles of the wheels. In this engine the sides of the rectangle are double, or, as far as regards the sides, there are virtually two framings, one for the reception of the driving axles, and the other for the reception of the axles not connected with the engine. The whole of the parts of the outer and inner framings are connected together by knees at the corners, and the double sides are elsewhere connected by intervening brackets and stays, so as to constitute the whole into one rigid structure. The whole of the plating of the inside frame is $\frac{3}{4}$ inches thick and 9 inches deep. The plating of the outside frame is of the same thickness and depth at the fore part, until it reaches abaft the position of the cylinders and guides, where it reduces to $\frac{1}{2}$ inch thick. The axle guard of the leading wheels is formed of $\frac{3}{4}$ plate bolted to the frame with angle iron guides. The axle guards of the trailing wheels are formed of two $\frac{1}{2}$ inch plates, with cast iron blocks between them to serve as guides. The ends of the rectangular frame are formed of plates $\frac{3}{4}$ thick, and at the front end there is a buffer beam of

oak $4\frac{1}{2}$ inches thick and 15 inches deep. The draw bolt is 2 inches diameter. There are two strong stays on each side, joining the barrel of the boiler to the inside framing, and one angle iron on each side joining the bottom of the smoke box to the inside framing.

660. Q.— Of what construction are the wheels?

A.— The wheels and axles are of wrought iron, and the tires of the wheels are of steel. The driving wheels are 6 feet $6\frac{1}{2}$ inches in diameter, and the diameter of crank pin is $3\frac{1}{2}$ inches. The diameter of the smaller wheels is $48\frac{1}{2}$ inches. The axle boxes are of cast iron with bushes of Fenton's metal, and the leading axle has four bearings. The springs are formed of steel plates, 3 feet long, 4 inches broad, and $\frac{1}{2}$ inch thick. The axle of the driving wheel has two eccentrics, forged solid upon it, for working the pumps.

661. Q.— Will you specify the dimensions of the principal parts of the engine?

A.— Each of the cylinders, which is $14\frac{1}{2}$ inches diameter, has the valve casing cast upon it. The steam ports are 18 inches long and $1\frac{1}{2}$ inches broad, and the exhaust port is $2\frac{1}{2}$ inches broad. The travel of the valve is $4\frac{1}{2}$ inches, the lap 1 inch, and the lead $\frac{1}{4}$ inch. The piston is 4 inches thick: its body is formed of brass with a cover of cast iron, and between the body and the cover two flanges, forged on the piston rod, are introduced to communicate the push and pull of the piston to the rod. The piston rod is of iron, $2\frac{1}{2}$ inches diameter. The guide bars for guiding the top of the piston rod are of steel, 4 inches broad, fixed to rib iron bearers, with hard wood $\frac{1}{4}$ of an inch thick, interposed. The connecting rod is 6

feet long between the centres, and is fitted with bushes of white metal. The eccentrics are formed of wrought iron, and have $4\frac{1}{2}$ inches of throw. The link of the link motion is formed of wrought iron. It is hung by a link from a pin attached to the framing; and instead of being susceptible of upward and downward motion, as in the case of the link represented in *fig.* 61., a rod connecting the valve rod with the movable block in the link, is susceptible of this motion, whereby the same result is arrived at as if the link were moved and the block was stationary. One or the other expedient is preferable, according to the general nature of the arrangements adopted. The slide valve is of brass, and the regulator consists of two brass slide valves worked over ports in a chest in the steam pipe, set in the smoke box. The steam pipe is of brass, No. 14. wire gauge, perforated within the boiler barrel with holes $\frac{1}{16}$ th of an inch in diameter along its upper side. The blast pipe, which is of copper, has an orifice of $4\frac{1}{4}$ inches diameter. There is a damper, formed like a venetian blind, with the plates running athwartships at the end of the tubes.

662. Q.—Of what construction is the safety valve?

A.—There are two safety valves, consisting of pistons $1\frac{3}{8}$ inch in diameter, and which are kept down by spiral springs placed immediately over them. A section of this valve is given in *fig.* 62.

663. Q.—What are the dimensions of the feed pumps?

A.—The feed pumps are of brass, with plungers 4 inches diameter and $3\frac{1}{4}$ inches stroke. The feed pipe is of copper, 2 inches diameter. A good deal of

Fig. 62.

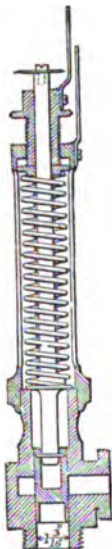

SAFETY VALVE. Gooch.

Fig. 63.

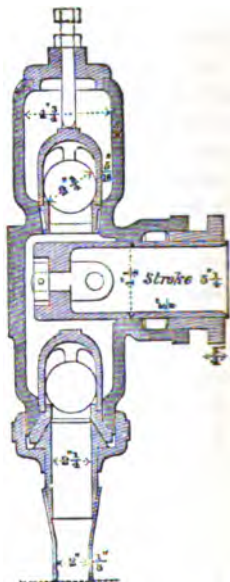
SECTION OF LOCOMOTIVE FEED
PUMP.

trouble has been experienced in locomotives from the defective action of the feed pump, partly caused by the leakage of steam into the pumps, which prevented the water from entering them, and partly from the return of a large part of the water through the valves at the return stroke of the pump, in consequence of the valve lifting too high. The pet cock—a small cock communicating with the interior of the pump—

will allow any steam to escape which gains admission, and the air which enters by the cock cools down the barrel of the pump, so that in a short time it will be in a condition to draw. The most ordinary species of valve in the feed pumps of locomotives, is the ball valve represented in *fig. 63.*, in which the lift is much less than was at one time usual. *Fig. 63.* is a section of a feed pump, showing the ball valves and plunger

Notwithstanding the excellent performance of the best examples of locomotive engines, it is quite certain that there is still much room for improvement; and indeed various sources of economy are at present visible, which, if properly developed, would materially reduce the expense of the locomotive power. In all engines the great source of expense is the fuel; and although the consumption of fuel has been greatly reduced within the last ten or fifteen years, it is capable of being still further reduced by certain easy expedients of improvement, which therefore it is important should be universally applied. One of these expedients consists in heating the feed water by the waste steam; and the feed water should in every case be sent into the boiler *boiling hot*, instead of being quite cold, as is at present generally the case. The ports of the cylinders should be as large as possible; the expansion of the steam should be carried to a greater extent; and in the case of engines with outside cylinders, the waste steam should circulate entirely round the cylinders before escaping by the blast pipe. The escape of heat from the boiler should be more carefully prevented; and the engine should be balanced by weights on the wheels, to

obviate a waste of power by yawing on the rails. The most important expedient of all, however, lies in the establishment of a system of registering the performance of all new engines, in order that competition may stimulate the different constructors to the attainment of the utmost possible economy; and under the stimulus of comparison and notoriety, a large measure of improvement would speedily ensue. The benefits consequent on public competition are abundantly illustrated by the rapid diminution of the consumption of fuel in the case of agricultural engines, when this stimulus was presented. The particulars of the performance of these engines are detailed in the following chapter.

CHAP. XI.
ON VARIOUS FORMS AND APPLI
THE STEAM ENGINE.

PORTABLE AGRICULTURAL EN

664. Q. — Having now described the forms of the steam engine as employed in water and accomplishing locomotion, w to describe some of its most approved fo to miscellaneous uses in the arts?

A. — The purposes for which the employed in the arts are of infinite v long been employed to give motion to of cotton, flax, woollen, and corn mills, the moving power for manufactories. Quite recently, however, it has found a new class of engines has been called in tion in aiding the operations of agri meet this demand. Many of these great elegance and efficiency. They a rule simple in construction, very co contrived as not to be liable to derang the hands of unskilful persons. The engines are divisible into two main clas engines set on wheels, somewhat in th

locomotive, and which may be drawn by horses from place to place; and fixed engines, which are set up where there is constant work to do. Many of the fixed engines are excellent examples of the kind of engine suitable for driving manufactories, and a description of these engines, therefore, will be understood as constituting a description of the kind of engines suitable for manufactories and mills.

665. *Q.* — Will you describe the main features of the portable engine?

A. — The portable agricultural engines of the principal makers of that species of engine, are in all their main features similar to one another. They all consist of a boiler with an internal fire box, and horizontal tubes resembling very much a locomotive boiler, and on the top of the boiler a cylinder is fixed with the connecting rod attached to the end of the piston rod, as in a locomotive, and the connecting rod turns the crank of a shaft extending across the top of the boiler, on which shaft pulleys are placed to communicate the motion of the engine by means of belts to any mechanism which requires to be driven. In the subordinate features of each engine, however, there are differences which render any one engine more or less eligible than the rest. *Fig. 64.* represents the portable agricultural engine of Messrs. Ransomes and Sims.

666. *Q.* — What are the distinctive features of this engine?

A. — The engine proper is mounted upon the top of the boiler, and is in all its parts of the simplest character, the various details having been matured by the fruits of a long experience under all kinds of

RANSOMES AND SIMS' ENGINE

Fig. 64.

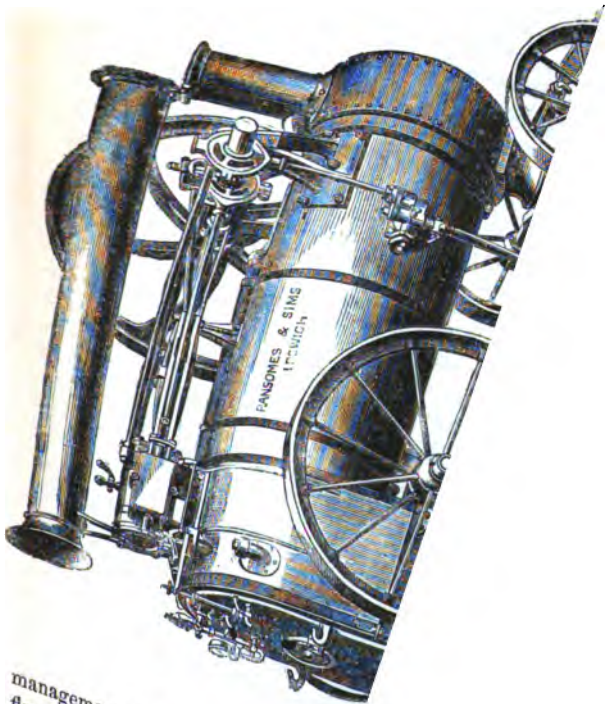

management, in every quarter of the
fly-wheels are accurately balanced; u

tied to the crank shaft brackets by connecting tie bolts, and which take the strain off the bolts connecting the bracket with the boiler; the fore-axle is connected to the boiler by means of a hemispherical locking-gear, which allows of the boiler always resting upon three points.

For a portable engine the size of the boiler is limited by the condition that the engine must be easily movable from place to place, and Messrs. Ransomes' engines give off, with a pressure of 60 lbs. per square inch in the boiler, about double their nominal power, as measured by the dynamometer. This is accomplished by working the piston at a quick speed, whereby large power is reconciled with moderate dimensions and small weight. These portable engines are manufactured upon a uniform system, from 3-horse power to 20-horse power, nominal powers, and have long been honourably distinguished for the faithfulness of their construction, and the intelligence which has presided over all the arrangements.

Messrs. Ransomes and Sims' fixed engine is represented at page 477. Their 8-horse power fixed engine has, on several occasions, taken the first prize of the Royal Agricultural Society of England. It was supplied with steam from a portable boiler belonging to the Society; and as this boiler was not the most economical, the result, in the consumption of fuel, which was 6 lbs. per horse power per hour, can only be taken as compared with engines tried with the same boiler and under the same circumstances.

667. Q.—Will you describe the portable agricultural engines of Messrs. Clayton and Shuttleworth?

BY CLAYTON AND CO.

A. — These engines are represented
figs. 65. and 66. The efforts of Me
Clayton and Shuttleworth to simplify
perfect this species of engine, have
a very powerful operation in inducing
extended adoption by farmers and
tractors; and great numbers of port
engines of similar configuration are
constructed by the manufacturers of a
cultural engines. Messrs. Clayton

Fig. 65

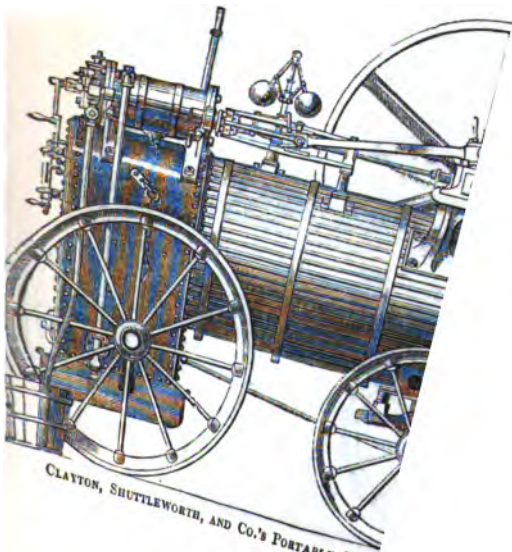

CLAYTON, SHUTTLEWORTH, AND CO.'S PORTABLE ENGI

Shuttleworth state, that the clumsy and dangerous boilers put into the hands of farmers up to 1845, at that time attracted their attention from the number of accidents arising in consequence of such defects; and the machinery was altogether so precarious, that it was unsafe for any but an experienced man to be trusted with its custody, thus rendering it as much an incumbrance as a benefit to the farmer. In 1849 they entered into

Fig. 66.

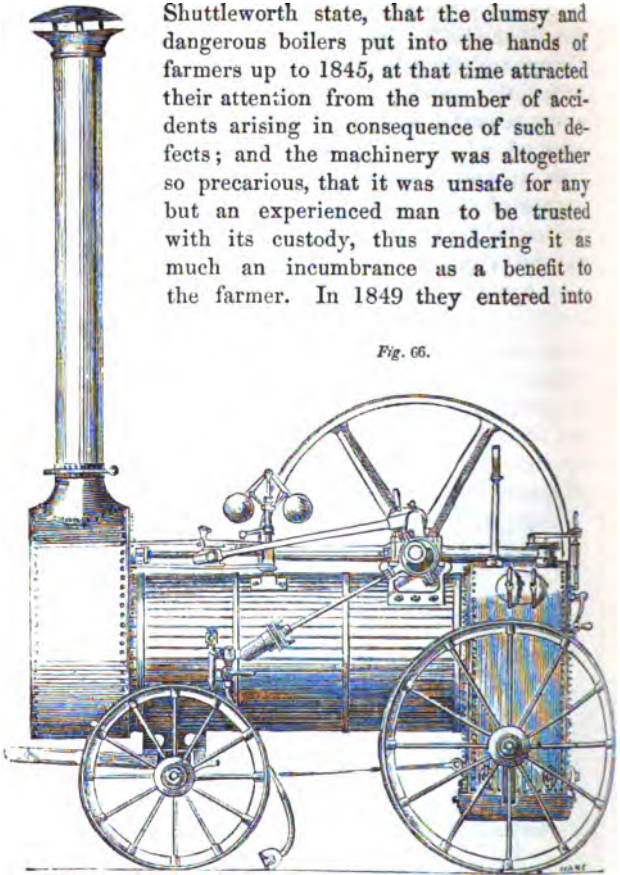

CLAYTON AND SHUTTLEWORTH'S PORTABLE ENGINE. Elevation.

competition with other makers at the Norwich show of the Royal Agricultural Society, and obtained the second prize of 25*l.*, since which time the number of prizes they have taken, and the quantity of engines they have sold and delivered, attest the high opinion in which their engines are held both by the judges of the Royal Agricultural Society and the general public. These makers state, that up to 1864 they have manufactured nearly *seven thousand* steam engines, of which they manufactured 664, of 5520 collective horses power, in 1864.

The following tabular statement of the duty done at various epochs, shows that there has been a gradual increase in the efficiency of these engines, owing to improvements from time to time introduced. Since 1855 the consumption has been still further reduced, and some portable engines have worked with as little as 3½ lbs. of coal per actual horse power.

DUTY OF CLAYTON, SHUTTLEWORTH, and Co's ENGINES, at the Experiments tried before the Judges of the Royal Agricultural Society of England.

Years.	Horses' Power.	Time getting up steam to 45 lbs. per inch.	Coal used in getting up steam to 45 lbs. per inch.	Coal burnt per Horse Power per Hour, while doing the work of One Actual Horse Power.
	H. P. Engine.	Minutes.	Lbs.	Lbs.
1849	5	44	22·25	11·8
	7	45	27·75	10·78
	9	37	41·25	11·66
1850	7	43	26·5	7·77
1851	6	32	25·4	8·63
1852	6	32½	22·75	6·0
	4	41	29·5	8·40
1853	4	47	17·75	4·32
1854	6	39		5·19
1855	8	34		4·05

462 CROSSKILL'S PORTABLE ENGINE.

In one of these figures the cylinder is represented as being set at the fire box end of the boiler, but in the more recent examples of their engines it is set in the smoke box at the foot of the chimney. The cylinder is surrounded by a steam jacket, which is kept at the temperature of 400° by the escaping smoke.

668. Q. — Will you describe Messrs. Crosskill's portable engine?

A. — This engine, which is set on

Fig. 67.

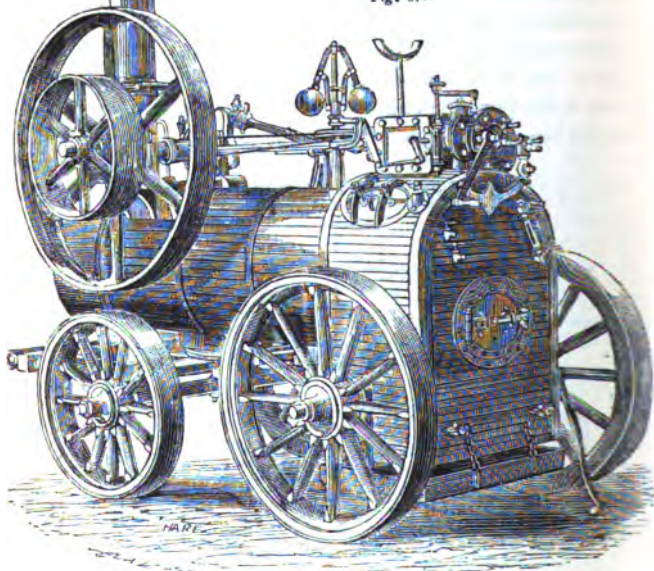

CROSSKILL'S PORTABLE AGRICULTURAL ENGINE.

four wooden wheels, is represented in *fig. 67*. A regulator, with a handle resembling those used in locomotives, lets the steam into the cylinder, which lies on the top of the fire box. The crank shaft lies across the barrel of the boiler at the chimney end, and the general arrangements of the engine, which will be obvious from the figure, nearly resemble those of some of the engines already described.

669. Q.— Will you describe the portable engine of Messrs. Garrett and Son?

A.—The portable engine of Messrs. Garrett and Son does not differ much from the best forms of the other makers. They however balance the momentum of the piston and its connections by casting a weight upon the fly-wheel; and besides the ordinary safety valve and lever with a spring balance, fitted in other engines, they introduce a second safety valve immediately pressed down by a strong spiral spring. The valve casing is cast upon the cylinder, instead of being jointed thereto in the usual manner, and the feed pump is fitted with double delivery valves. Latterly, Messrs. Garrett and Son's portable engines have been much employed for steam ploughing under an arrangement described in the Introduction. Messrs. Garrett and Son state that the bearings and other rubbing surfaces of their engines are made large to reduce the wear; that they use wrought iron in preference to cast, whenever it is possible to do so; that the carriage of their engine is of wrought iron, and that a tank is attached to it, to obviate the necessity of carrying a tub about with the engine from place to place. The cylinder is provided with a steam jacket,

an arrangement which has been found advantageous in all cases, but more especially in those in which expansive action of the steam is employed. A representation of these engines is given in *fig. 68.*; and Messrs. Garrett and Son state, that besides an extensive home trade, they export large numbers of engines to Australia, Hungary, India, and other places,

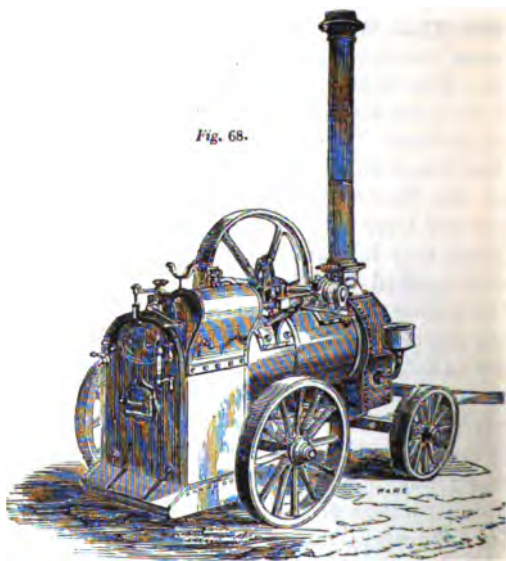

GARRETT AND SON'S PORTABLE AGRICULTURAL ENGINE.

and that they were engaged by the government to construct road locomotives for the Crimea. Messrs. Garrett are also extensive manufacturers of fixed engines. Their fixed engine is constructed with an

inverted cylinder on a cylindrical column, which contains all the working parts,—the fly wheel shaft being placed below.

670. Q.—What other engines of this class have you to enumerate?

A.—The portable engine of Messrs. Bach and Co. is represented in *fig. 69.*, that of Messrs.

Fig. 69.

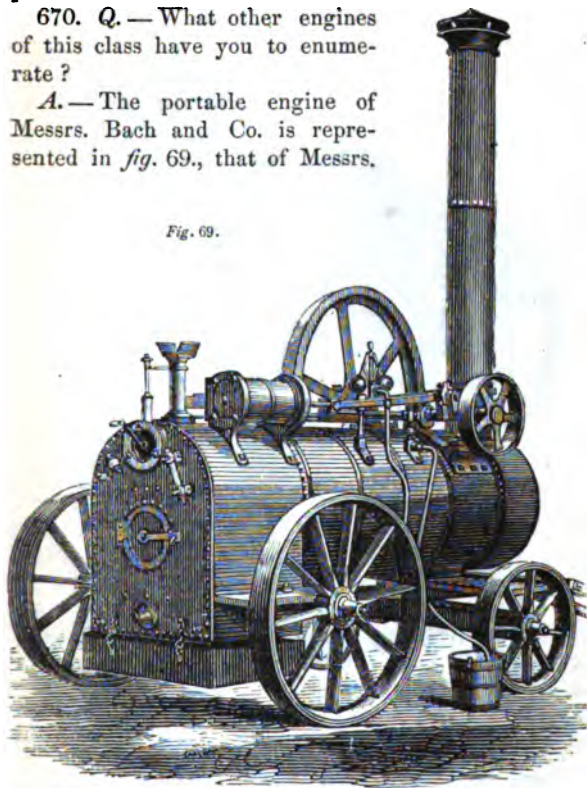

BACH & CO.'S PORTABLE STEAM ENGINE.

HH

E. R. and F. Turner in *fig. 70.*, and that of Messrs. Hornsby and Son in *fig. 71.*

Fig. 70.

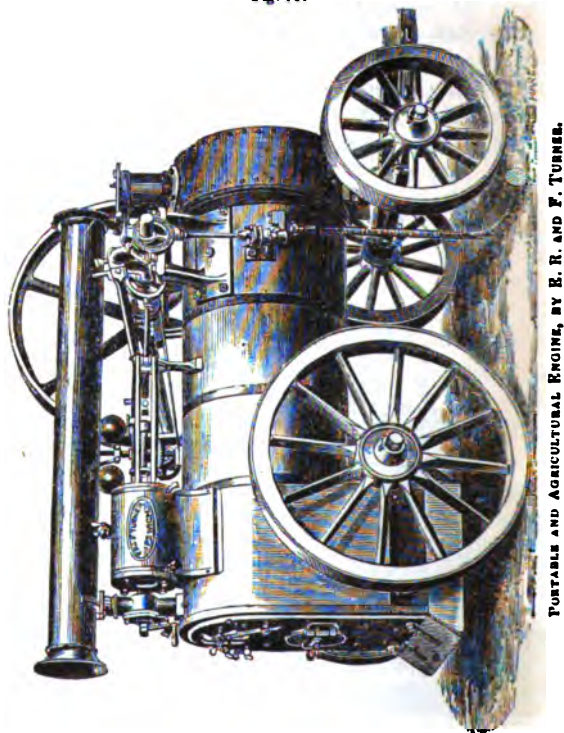

PORTABLE AND AGRICULTURAL ENGINE, BY E. R. AND F. TURNER.

671. Q — Will you describe Messrs. Turner's engine ?

A.—This engine is of 4 horses power. The boiler is of the locomotive form, part, made of plates $\frac{1}{4}$ in. thick, shell $\frac{1}{8}$ th plate. Fire box of $\frac{3}{8}$ th plate, $\frac{1}{8}$ th inch thick, of best Lowmoor iron. 22 in number, and $2\frac{1}{2}$ inches diamet grate there is a sliding ash pan, fitted clearing the bars, and which also serves the draught. The cylinder is 6 inches mounted on one side of the shell, over The steam pipe is formed by a small also carries a disc starting valve and the whilst the top forms a rest for the which it is laid back when the engine. By combining these uses in the column much drilling and bolting, as well as boiler, is avoided. The guide of the formed of two planed wrought iron bars one end by the cylinder cover, and at suitable iron standard. A bracket carries on the boiler near the chimney, carrying for the crank shaft, which is of 12 inches diameter. The fly-wheel is 4 feet in diameter, and answers for a driving pulley. makes 140 revolutions per minute; the stroke is $10\frac{1}{2}$ inches; pressure of steam 45 lbs. per square inch. The consumption of water about 10 hours; during work engine will thrash out 40 quarters of wheat same time riddle it and shake the straw. Performance is the same as that of Messrs.

and Andrewes' engine, as recited at page 499, and the figures there given may be taken as representing the average performances of portable agricultural engines of good construction at the present time. In the smaller class of engines the performance will be somewhat inferior to what it is in the larger; and the result, therefore, will not be precisely the same as is given in the table, where the comparative efficacy of all the classes is set down as the same. The best modern engines will work with a rather larger maximum efficiency.

672. Q.—Will you describe the portable engine of Messrs. Hornsby and Son?

A.—This engine appears to be fully as efficient, as regards economy of fuel, as any portable engine yet manufactured; a distinction which it probably in a great measure owes to the situation of the cylinder, which is placed within the boiler. An 8 horse power engine of these makers weighs 58 cwt., and burns very little over 4 lbs. of coal per horse power per hour, and in some cases the consumption has been as low as $3\frac{1}{2}$ lbs. per actual horse power per hour. Messrs. Hornsby have obtained more prizes for their engines probably than any other makers; and in the great exhibitions of 1851 and 1862, the Paris Exhibition of 1855, and the Hamburgh Exhibition of 1863, they obtained prize medals. A portable engine of the form manufactured by Messrs. Gardiner and Mackintosh of New Cross, London, is represented in *fig. 73*.

633. Q.—Will you describe the portable agricultural engine of Messrs. Tuxford and Sons?

A.—In this engine, which is represented in

HORNSBY AND SON'S PORTABLE :

Fig. 71.

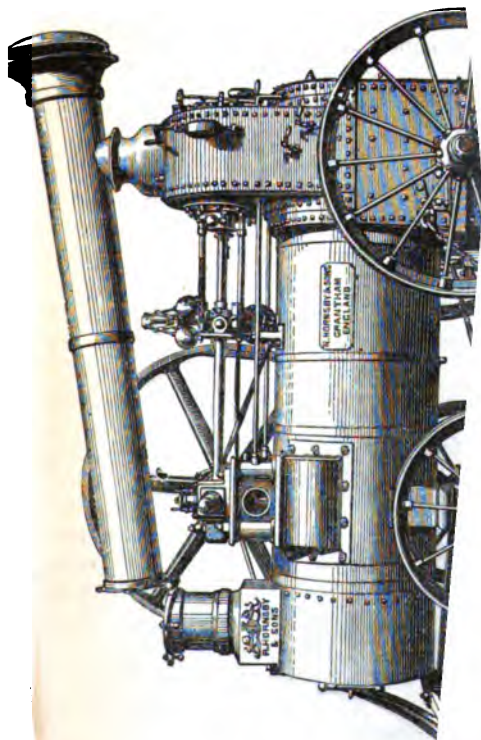
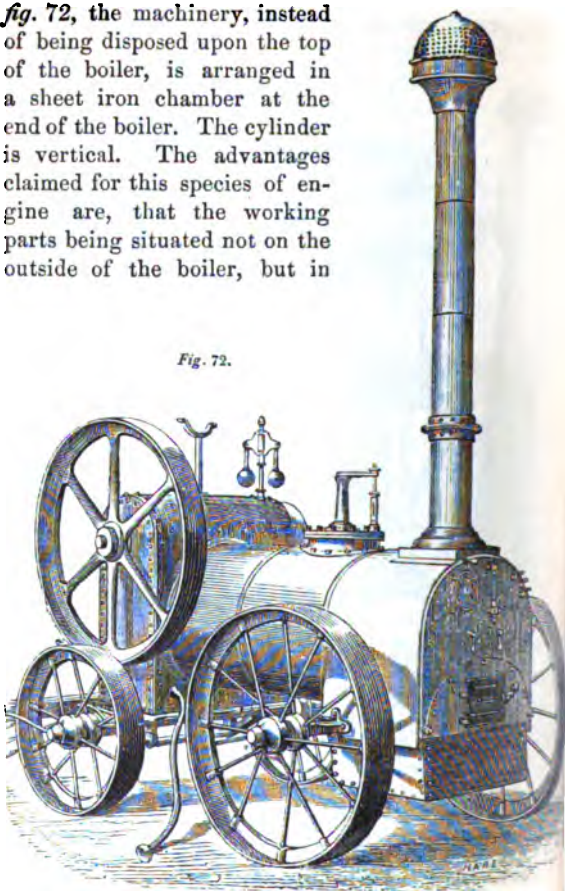

fig. 72, the machinery, instead of being disposed upon the top of the boiler, is arranged in a sheet iron chamber at the end of the boiler. The cylinder is vertical. The advantages claimed for this species of engine are, that the working parts being situated not on the outside of the boiler, but in

Fig. 72.



TUXFORD AND SONS' PORTABLE AGRICULTURAL ENGINE.

TUXFORD AND SONS' PORTABLE

a sheet iron box, which may be lock
liable than common engines to be inju
rain, or to be damaged by meddling sp

Fig. 73.

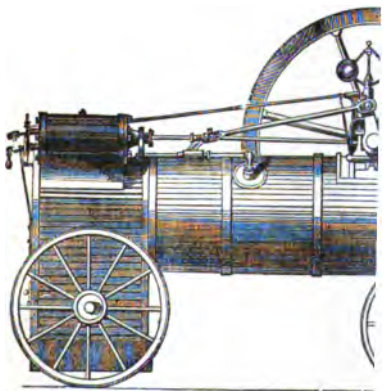

GARDINER AND MACINTOSH'S PORTABLE

theft of the brass work. It is also
the cylinder, from being vertical, is
wear oval as in engines where th
on its side.

674. Q.— Will you describe th
adopted in Mr. Burrell's engine ?

A. — This engine, which is represented in *fig. 74.*, is a simple and well proportioned engine, with the cylinder arranged on the top of the boiler, as is the

Fig. 74.

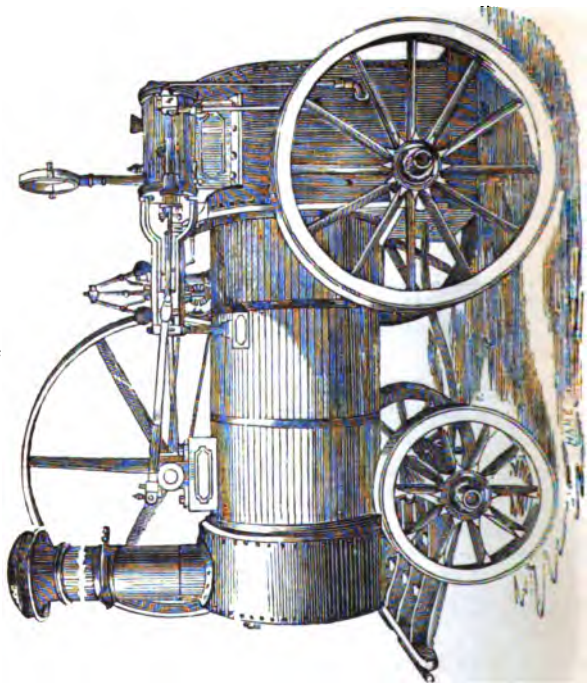

G. BURRELL'S PORTABLE AGRICULTURAL ENGINE.

prevailing practice in engines of this class. The engine is fitted with a hot water cistern, by the use of which, in connection with other improvements, a considerable saving of fuel is obtained.

675. Q.—What other portable agricultural engines are there which appear to you to merit description?

A.—There is the engine of Messrs. Barrett, Exall, and Andrewes, represented in *fig. 75.*, and which is a highly efficient and well contrived engine. In this engine the cylinder is set upon the boiler, and the saddle by which

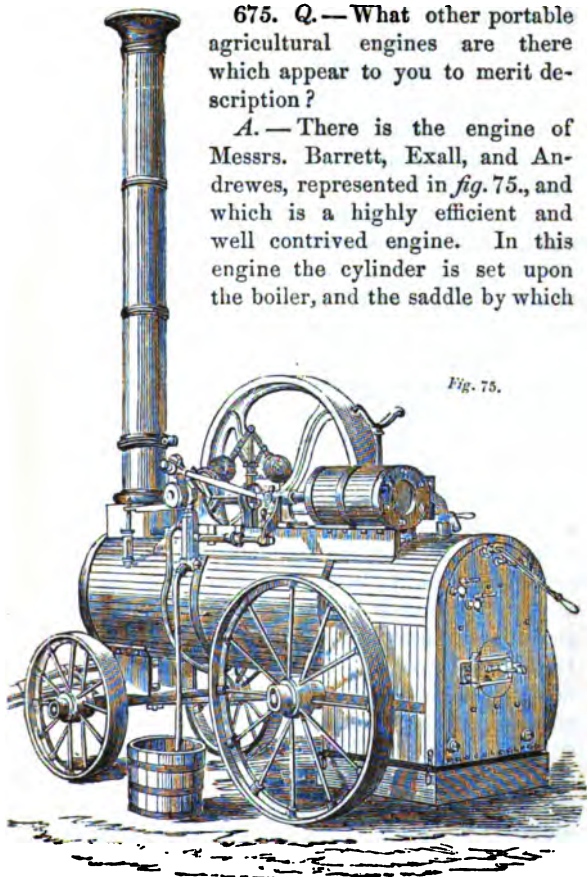

BARRETT, EXALL, AND ANDREWES' PORTABLE AGRICULTURAL ENGINE.

the cylinder is attached to the boiler is formed into a steam chest, which both helps to keep the cylinder hot and to obviate priming. In an engine constructed upon this plan, any ice which may form within the engine in winter when it is not at work, is gradually thawed and dissolved out as the steam is got up, so that there will be no impediment to the engine being started when the steam has attained a sufficient elasticity. Most of the other makers have suitable provisions for insuring the same result. The main incidents of the performance of Messrs. Barrett, Exall, and Andrewes' engine, as ascertained by the makers, are given in page 499. Messrs. Barrett and Co. claim to have reduced the weight of the portable engine considerably. The boiler and cylinder are covered with hair felt and wood lagging to prevent any undue dispersion of the heat, and each engine is fitted with safety valve, governor, water gauge, two gauge cocks, blow off cock and mud holes, ash pan, damper, drag shoe, stoking tools, flue brush, and water-proof cover. In Mr. Batley's engine the cylinder is also set in the smoke box at the foot of the chimney, and the general arrangements are very simple and compact. In Mr. Butlin's engine there is a steam dome above the fire box, to the side of which the end of the cylinder is attached, so that the cylinder lies in a horizontal line a little above the highest part of the barrel of the boiler. There are several other makers of portable agricultural engines, which have produced engines of a very efficient character ; but any recent feature of importance is noticed in the Introduction.

676. Q — Will you specify the ge
of these engines?

A. — The portable engines of the p
are very admirable examples of steam
they combine in a very eminent degr
qualities of cheapness, simplicity, and
average cost of these engines varies f
per horse power in the case of th
engines, say of 4 horses power; and fro
horse power in the case of the larger c
say of 10 horses power. The best eng
a consumption of under 4 lbs. of coal
per hour, and the simplicity of the s
such as to enable an ignorant far
assume the charge of an engine, w
preliminary instruction. It cannot b
the constant strain kept up among
these engines to outdo one another at
exhibitions of agricultural machinery
parts of the kingdom, has led to a
improvement, especially in regard t
fuel; just as the publication of Lea
Cornwall, put all the engineers upon th
from the increased vigilance and con
thus excited, important ameliorations
It appears to be highly probable, th
this superior activity existing in t
makers of agricultural engines must
engines will gain a wider introduc
themselves expected, and occupy fi
monopolised by another class of mar
their engines burn less coals than ot
if they are more easily managed.

break—and can be obtained for less money—it requires no great penetration to foresee that a vast field will be opened to their skill and enterprise, which, but for the stimulus of competition, would never have been available. The main condition of exemption from break-downs lies in making the parts of what may be considered very superfluous strength. Heating of the bearings is to be prevented by large surfaces and good fitting. Economy of fuel is to be obtained by constructing the valves with much lap and lead, and throttling the steam by the governor; by working with a high pressure of steam, and giving little of it; by keeping the cylinder and boiler very hot, and by heating the feed water by the waste steam or smoke to the boiling point before sending it into the boiler. The fire grate should not be too large, else the heating surface of the tubes will not be so effective; for if the fire grate is large, the heat being more diffused will be less intense, and will be absorbed in the fire box with less rapidity, leaving consequently the tubes with more work to do.

FIXED AGRICULTURAL ENGINES.

677. *Q.*— Will you now proceed to describe some of the fixed agricultural steam engines that are most commonly employed?

A.— These engines are of very various kinds; some are horizontal, others beam, others oscillating; then there are table engines with side rods, resembling Maudslay's portable engine; there are also upright engines, with the cylinder overhead working down to the crank below, and engines with the cylinder below working up to the crank overhead.

Fig. 76.

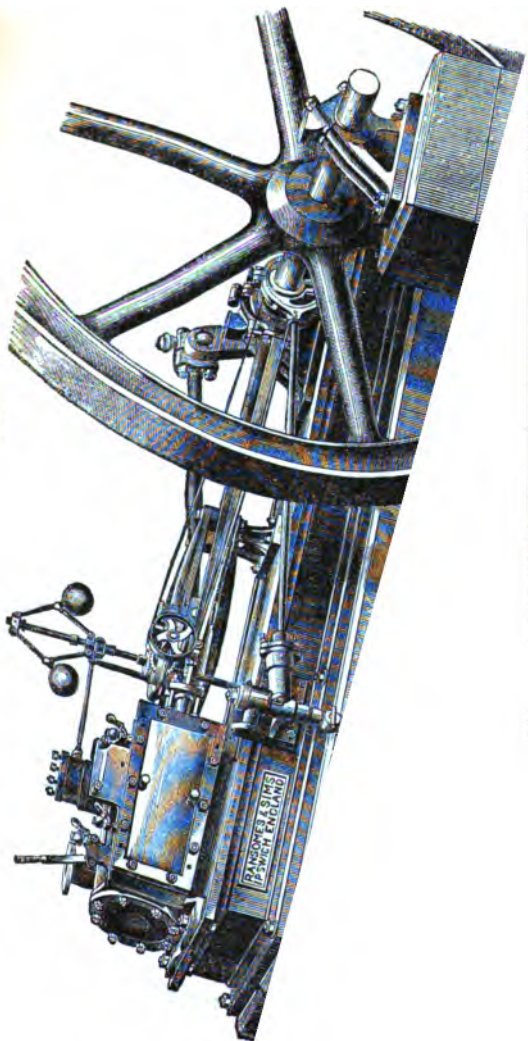

678. Q.— Will you indicate some of the principal

Fig. 77.

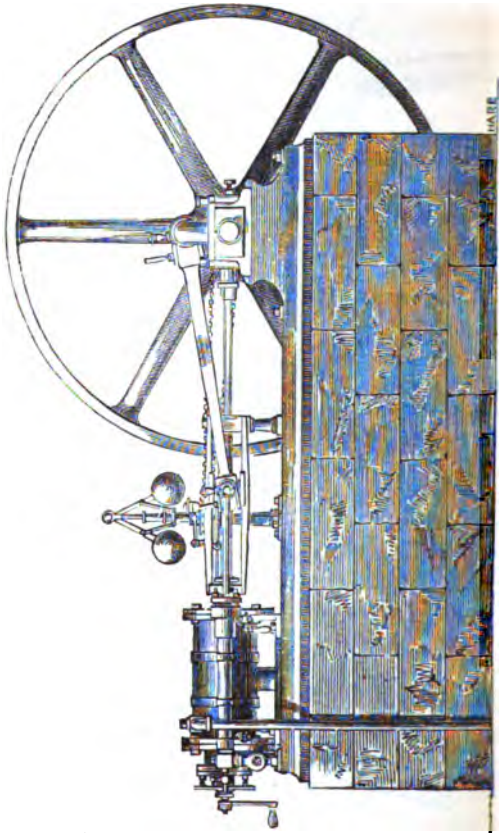

CLAYTON, SHUTTLEWORTH, AND CO.'S FIXED HORIZONTAL ENGINE.

forms of horizontal engine?

A.— Fig. 76. represents the fixed agricultural

type of all fixed engines of these makers, from 4 horses power up to 25 horses power. Above that power they usually place two engines side by side working upon a single shaft with fly-wheel between, and a crank at each end set at right angles to each other. In the sizes above 12 horses power, Messrs. Ransomes always fit their engines with a separate slide valve, so as to cut off the steam where required, and lower powers are also thus fitted when variable work has to be performed. The fixed horizontal engine of Messrs. Clayton and Shuttleworth, represented in *fig. 77.*, bears a near resemblance in all material points to the engine just described; and the same remark applies to the fixed horizontal engine of Messrs. E. R. and F. Turner, which is represented in *fig. 78.* Any points of deviation in the constructive arrangements of these engines will be made apparent by a comparison of the respective figures.

679. Q.—Will you describe the fixed engine of Messrs. Barrett, Exall, and Andrewes?

A.—*Fig. 79.* is a representation of Barrett, Exall, and Andrewes' fixed engine, and it is of the same type as some of those already described. The cylinder lies on its side on a strong bed-plate of cast iron, on which brackets are cast for sustaining the shaft plummer blocks. The crank is a double one, and is formed in one piece with the shaft. The slide valve, which lies on the further side of the cylinder, and is, therefore, not seen in the figure, is worked by an eccentric on the shaft, and another eccentric, on the side of the crank nearest the spectator, gives motion to the feed pump.

Fig. 79.

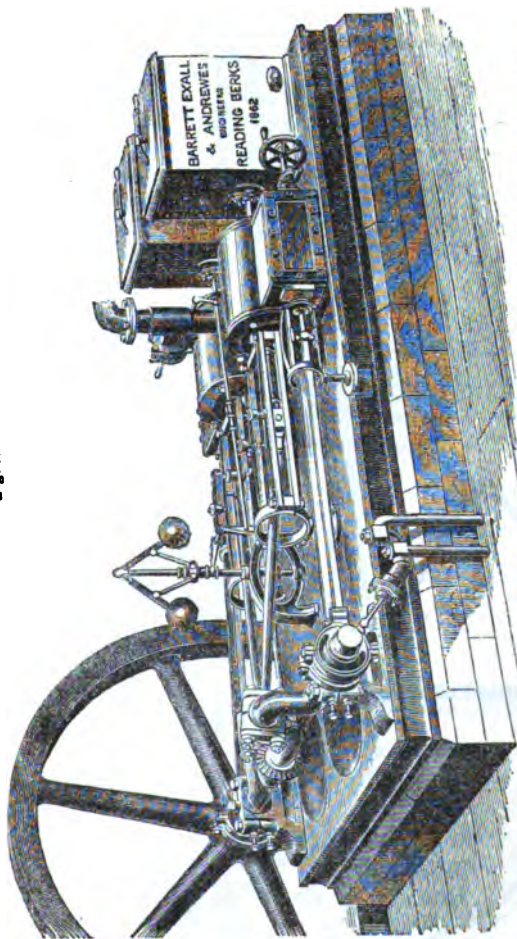

DOUBLE-CYLINDER HIGH PRESSURE EXPANSIVE AND CONDENSING ENGINE, BY BARRETT, EXALL, AND ANDREWES.
(NOW READING IRON COMPANY, LIMITED).

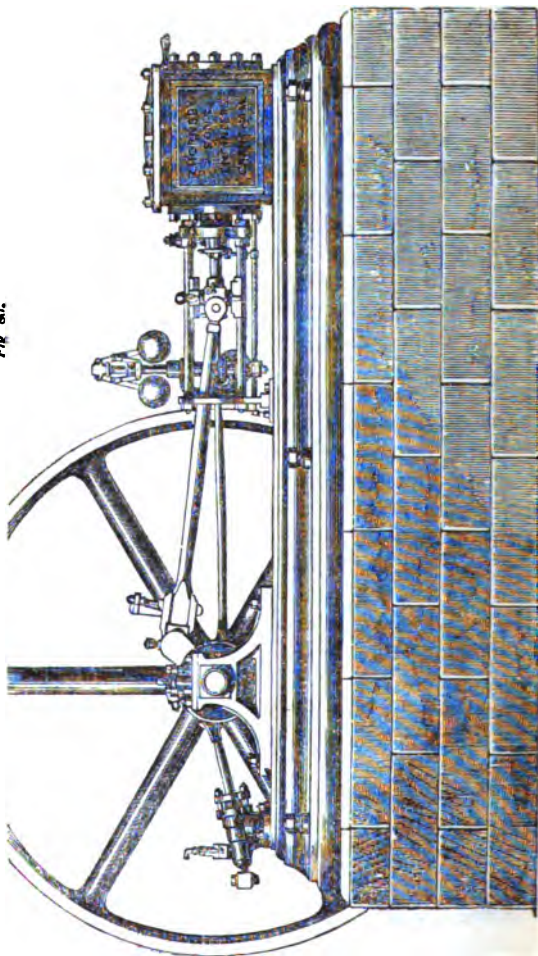
Fig 80.**HORNSBY AND SONS' FIXED HORIZONTAL ENGINE.**

680. Q.—What is the construction of Hornsby and Son's fixed engine?

A.—It resembles the horizontal engines already described, as will be seen by a reference to *fig. 80.*, which is a representation of that engine. The working parts, few in number, are easy of access for lubrication or adjustment. The engines are made with a centre crank, by which the oscillation of the shaft, and wear of the bearings, are reduced to the lowest point; and the shaft is made sufficiently long for fixing the fly-wheel on either side, or a pulley for a slower speed. The cylinder and valves are cased in a plate-iron steam jacket, which forms a heating surface around them. The piston is metallic. The slide-bars, pins, nuts, and eyes are case-hardened, and wrought-iron is used wherever practicable. The engines of these makers are supplied with cylindrical Cornish boilers of suitable size and strength. In all engines of this class intended to run at a high speed it is very advisable to have the crank double, as in Messrs. Hornsby's engine, and also to make the wearing surfaces large, and to balance the momentum by a revolving weight at the cranks.

681. Q.—What is the construction of the table engine?

A.—In the table engine the cylinder stands on a frame formed with four legs like a table. There is a cross head moving in guides, attached to the top of the piston rod, and from the ends of this cross head two side rods proceed to a similar cross head—or cross tail, as it is called—lying beneath the cylinder, and from the centre of which a short connecting rod proceeds to the

crank. The side rods, cross tail, and short connecting rod, form together a great forked connecting rod, of which the upper end is attached to the cross head, and

Fig. 81.

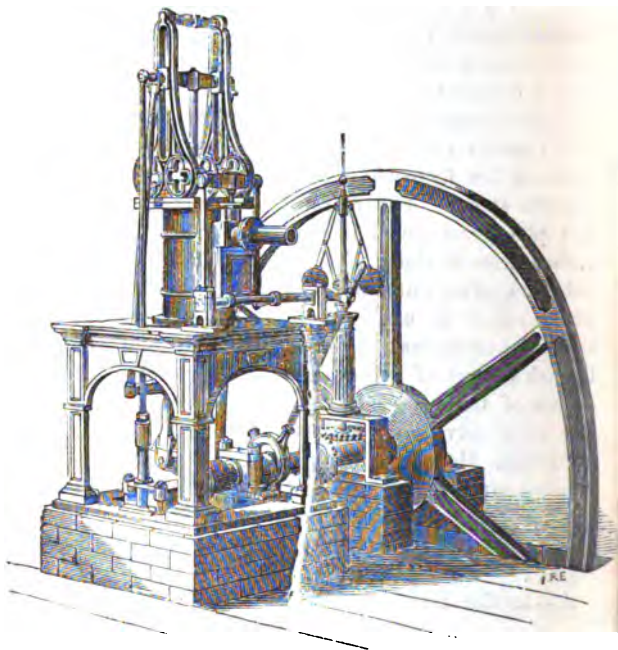

TUXFORD AND SONS' TABLE ENGINE. 12 horses power.

the lower to the crank. This is a species of engine, which was at one time much used for driving factories, and for such miscellaneous purposes as require a small power set in a small space; but it is now super-

seded by other engines of equal compactness and greater simplicity of construction. The table engine of Messrs. Tuxford and Sons is represented in *fig. 81.*, and it is a favourable example of engines of that class. An engine of a class similar to the table engine, is represented in *fig. 82.* This engine is made with a

Fig. 82.

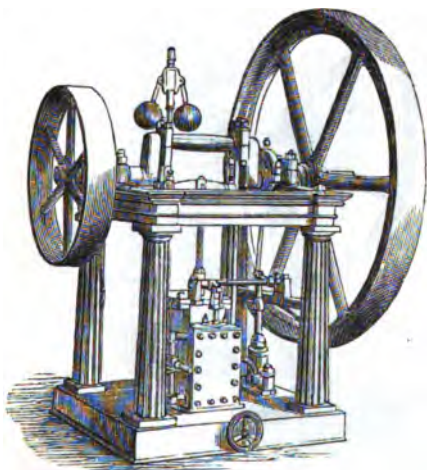

TUXFORD AND SONS' DOUBLE SIDE ROD ENGINE. 6 horses power.

cross head, as in the table engine, but the side rods are guided on their lower ends by guides on the sides of the cylinder, and from the lower ends of these side rods, other side rods—or they might be termed connecting rods—proceed to the crank, and put it into

486 TUXFORD AND SONS' OSCILLATING ENGINE.

revolution. The length of the crank pin by this arrangement exceeds the diameter of the cylinder. This kind of engine, though simpler than the table engine, is not so simple as the oscillating engine, though it has advantage over it in some respects.

Fig. 83

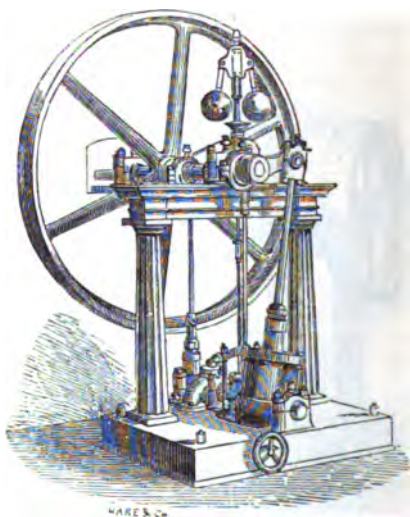

TUXFORD AND SONS' OSCILLATING ENGINE. 4 horses power.

682. Q.— Will you describe the arrangement of oscillating engine used for agricultural purposes?

A.— *Fig. 83.* represents the oscillating engine of Messrs. Tuxford, and *fig. 84.* represents Crosskill's oscillating engine. In most of these small engines the

valve is worked by the oscillation of the cylinder; but one detriment of that arrangement is, that the

Fig. 84.

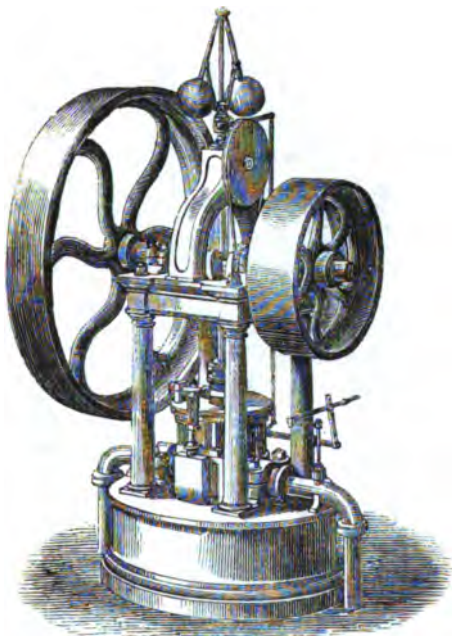

CROSSKILL'S OSCILLATING ENGINE.

proper degree of lead is not given, and it appears preferable to employ an eccentric in all cases in which the engine is run at a high rate of speed.

683. Q.—Will you now describe some of the varieties of vertical engines?

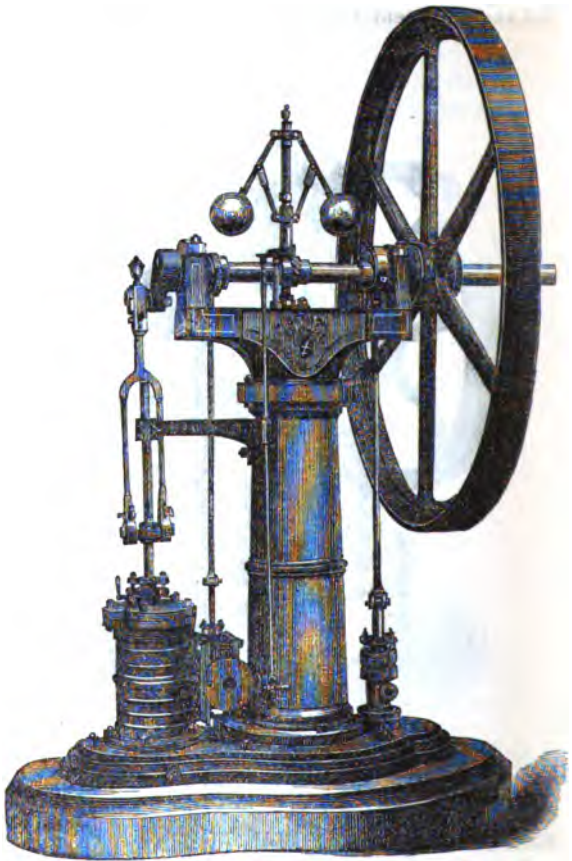
Fig. 81.

BENSON'S VERTICAL ENGINE.

A.—*Fig. 85.*, which is a representation of Benson's fixed rotative engine, is an engine of this character.

Fig. 85.

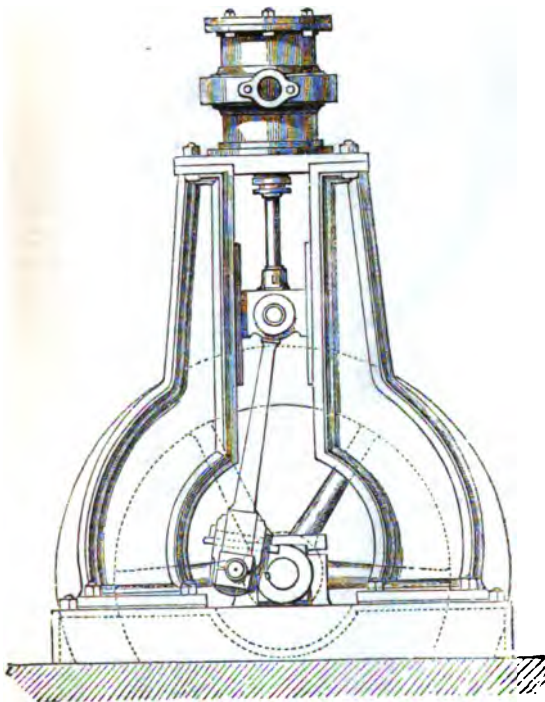

NASMYTH'S ROTATIVE ENGINE.

The cylinder, with the piston rod proceeding from its upper part, is set upon a sole plate of cast iron, and the end of the piston rod, which is attached to the con-

Fig. 87.

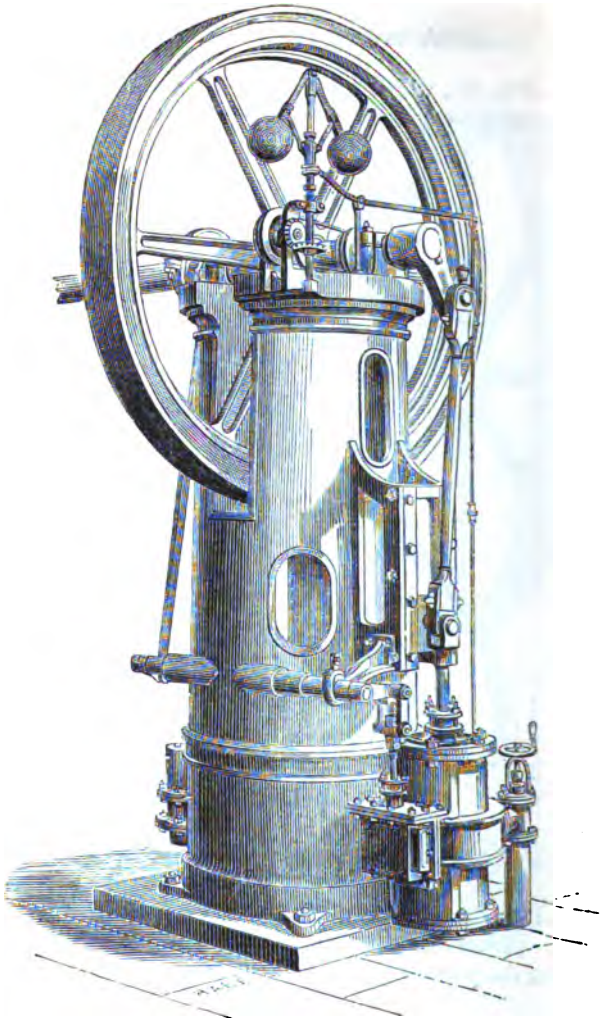

FERRABEE'S PILLAR ENGINE.

necting rod moves in an eye. The connecting rod is forked, and the fly-wheel shaft is supported on the top of a stout cast iron column, and drives the governor by oblique gearing. The woodcut will enable the general features of the engine to be easily understood. Another species of vertical engine is given in *fig. 86.*, which represents Nasmyth's variety of inverted engine. This engine in its general arrangement resembles that of his steam hammer, only that it is provided with a crank and fly-wheel, of which the steam hammer is, of course, destitute. This is a cheap and simple species of engine; it stands in little room, is very strong, and acts well.

684. Q.—Will you give another example of an engine with the crank aloft and the cylinder below?

A.—An engine of this kind is represented in *fig. 87.*, which is the engine of Messrs. Ferrabee of Stroud. The crank shaft is laid across the top of a strong hollow pillar, out of which a hole is mortised to allow the fly wheel to revolve. The cylinder is bolted to the bottom of the same pillar. The slide valve is worked by a weigh shaft. The base of the column forms a water cistern for replenishing the boiler, into which the steam is discharged from the cylinder. The feed pump, worked by an eccentric on the crank shaft, is bolted to the base of the column with the supply valve *below* the water in the cistern, thereby insuring the action of the pump when the water is nearly at boiling point. The engine is fitted with a simple cut off valve for working the steam expansively, thereby economising fuel.

685. Q.—What is the usual price of the fixed agricultural engines?

A.—The price per horse power varies with the size. A four horse power engine costs from 33*l.* to 35*l.* per horse power; a ten horse power engine from 22*l.* to 27*l.* per horse power; and a thirty horse power engine about 19*l.* per horse power. This price includes boiler.

686. Q.—For what purposes about a farm are steam engines principally used?

A.—For thrashing corn, pumping water, sawing timber, bruising oats or beans, chopping up hay, and a number of other similar purposes. Sometimes the waste steam is made use of to cook the food of cattle, and to heat drying lofts. Engines of some of the classes described are much used by contractors for pump water, mixing mortar, moulding bricks, hoisting stones, and performing other laborious tasks, for which a considerable amount of power is required.

687. Q.—Has the steam engine been applied to the operation of ploughing?

A.—It cannot be said to have been yet applied practically, though experiments have been made which seem to indicate that such an application is by no means impossible. One of the plans proposed is to have a locomotive engine advancing slowly along the opposite sides of a field, with a chain passing across the field from one engine to the other. This chain is wound and unwound by each engine alternately, and it carries with it a plough, making any required number of cuts. Another expedient is to have revolving ploughshares set on an axle, driven by a loco-

motive engine, which is slowly advanced by the ploughshares biting the ground, in the manner a

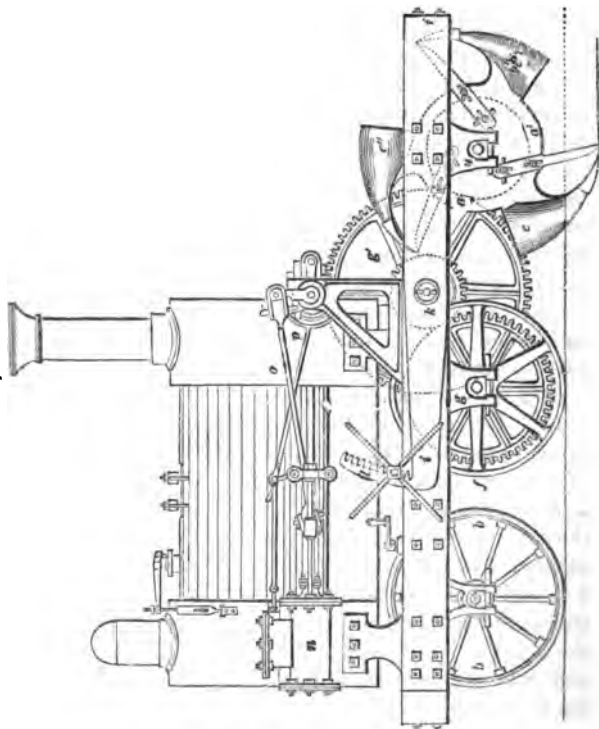

steam vessel is propelled by paddle wheels. This last expedient is termed Usher's steam plough, and it is represented in *fig. 88*.

688. Q.—Will you describe the structure and operation of Usher's steam plough?

A.—The machine substantially consists of a locomotive engine, with the fore wheels made to swivel, so as to guide the machine, while the hind wheels consist of a great drum stretching across beneath the engine, to prevent the weight from sinking the machine too deep in the soft ground. At the end of the engine an axle runs across, from side to side, carrying any required number of sets of revolving ploughshares, and this axle can be raised or depressed by appropriate mechanism, so as to give the ploughshares any amount of dip which may be found expedient. The axle carrying the ploughshares has its speed reduced, and its force of rotation increased, by the interposition of gearing between it and the engine.

689. Q.—Describe the apparatus in greater detail.

A.—Referring to the figure, $a a'$ is the wheel carrying the three ploughshares $e e' e''$; each ploughshare is preceded by a coulter or cutter, and a succession of similar wheels and ploughshares is set upon the axle, so that the machine ploughs its own breadth at once. The wheels of the fore carriage are lettered $b b$, and f is the great drum stretching across the engine to support the weight. This drum is fixed on the axle g . The cylinder of the engine is shown at κ , and o is the connecting rod turning the crank. On the crank shaft is placed a pinion p , working into the large spur wheel g' , which turns on the axle k ; and a pinion affixed to g' gives motion to a wheel fixed to the drum f . At the same time g' gears into a smaller wheel on the axis u , and so puts the rotating plough-

shares into revolution. The axle u is supported by the framework $i i$, which by turning round the cross handle attached to a small pinion gearing with the sector l , may be moved like a vibrating beam on the centre k , and the bite of the revolving ploughshares may therefore be increased or diminished by turning in the appropriate direction the cross handle at l . It will be obvious that as the frame $i i$ vibrates on the same centre on which the wheel g' revolves, that the elevation or depression of the ploughshares does not affect the gear of the wheels.

690. Q.— In pumping water on the small scale for agricultural and miscellaneous purposes, is it indispensable that the engine should be a rotative one?

A.— No; it may be made without a crank if judged preferable, but if so made it will of course be unsuitable for any of the uses for which a rotatory motion is necessary. For most purposes, moreover, the centrifugal pump is preferable to reciprocating pumps, as it utilises a larger proportion of the power of the engine, is without valves, which may choke or wear out, and lifts clean and dirty water indifferently. There are cases, nevertheless, in which reciprocating pumps moved by a reciprocating engine may be advantageously employed, and an arrangement suitable for such cases is represented in *fig. 89*.

691. Q.— Will you explain the details of this arrangement?

A.— In this engine the piston and pump plunger are directly connected by the piston rod, and the slide valve is moved by an arm on the piston rod, which strikes tappets on the valve rod. a is the cylinder,



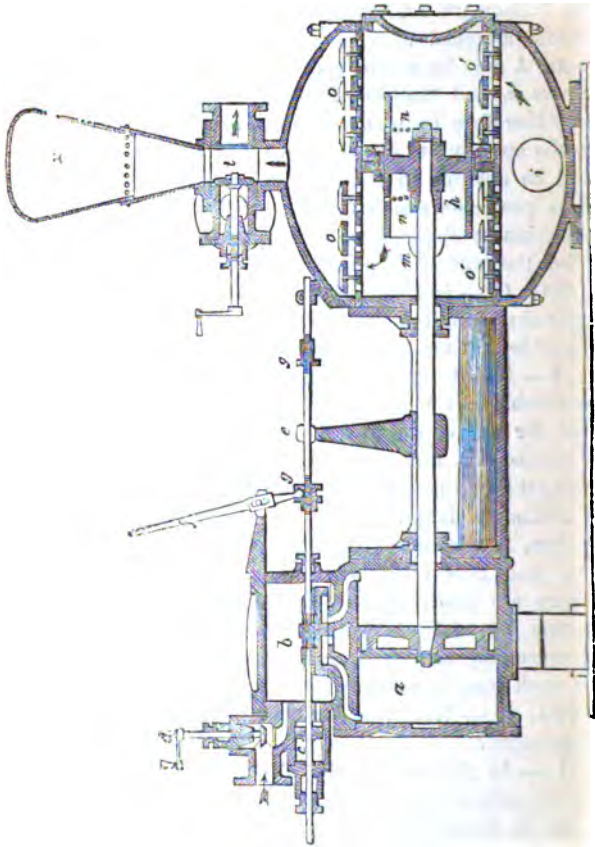

WORTHINGTON AND BAKER'S STEAM PUMP.

the valve ; and on the end of the valve rod there is a small piston working in the small cylinder *e*, with a groove along its lower side, and this cylinder communicates by a small hole with the valve casing. When the bosses *g g* are struck by the arm *e*, the small piston at *e* prevents the valve from being driven too far by the impact. The valve is moved at starting by the handle *f*, and *d* is a stop valve for regulating the admission of the steam. The plunger of the pump *h* is square, and the pump is double acting : *i* is the suction pipe, *o' o'* the suction valves, and *o o* the delivery valves. These valves are formed of india rubber discs moving on spindles up against flat guards : *n n* are small holes bored through the plunger, which have the effect of opening a communication between the two ends of the pump, just before the end of the stroke ; and their intention is to diminish the concussion of the water by allowing a little of it to escape, which will be tantamount to giving it a slight compressibility. *m* is a hand hole for getting ready access to the valves ; *t* is the delivery pipe, and *x* an air vessel on that pipe. This pump is found to work with great smoothness, and has been a good deal used in America for feeding steam boilers with water and for other purposes. In pumps, however, which are liable to a back leakage of hot water or steam, it is better to make them so that the plunger completely fills up the pump barrel ; and there should be no vacant spaces at the ends for the steam to lodge, but as far as possible precaution should be taken so that the whole contents of the barrel, whether liquid or vaporous, shall be expelled completely at every stroke.

692. Q.—Having now described the most usual and approved forms of engines applicable to agricultural purposes, and to the numerous miscellaneous purposes for which a moderate amount of steam power is required, will you briefly recapitulate what amount of work of different kinds an engine of a given power will perform, so that any one desiring to employ an engine to perform a given amount of work, will be able to tell what the power of such engine should be?

A.—It will of course be impossible to recapitulate all the purposes to which engines are applicable, or to specify for every case the amount of power necessary for the accomplishment of a given amount of work; but some examples may be given which will be applicable to the bulk of the cases occurring in practice.

693. Q.—Beginning, then, with the power necessary for thrashing,—you have already stated that a 4 horse power engine, with cylinder 6 inches diameter, pressure of steam 45 lbs. per square inch, and making 140 revolutions per minute, will thrash out 40 quarters of wheat in 10 hours with a consumption of 3 cwt. of coals?

A.—Although this may be done, it is probably too much to say that it can be done on an average, and about three-fourths of a quarter of wheat per horse power would probably be a nearer average. The amount of power consumed varies with the yield. Messrs. Ransome state that their 8 horse power engine will drive with ease two pair of mill stones 3 feet 8 inches diameter.

Messrs. Barrett, Exall, and Andrewes give the following table as illustrative of the work done, and

the fuel consumed by their portable engines ; and this must be regarded as a good performance : —

Number of Horse Power.	Weight of Engine.		Quarters of Corn threshed in 10 Hours.	Quantity of Coals consumed in 10 Hours.	Quantity of Water required for 10 Hours in Gallons.
	Tons.	Cwts.			
4	2	0	40	3	300
5	2	5	50	4	380
6	2	10	60	5	460
7	2	15	70	6	540
8	2	0	80	7	620
10	2	10	100	9	780

694. Q. — In speaking of horses power, I suppose you mean indicator horse power ?

A. — Yes ; or rather the dynamometer horse power, which is the same, barring the friction of the engine. At the shows of the Royal Agricultural Society, the power actually exerted by the different engines is ascertained by the application of a friction wheel or dynamometer.

695. Q. — Can you give any other examples of the power necessary for grinding corn ?

A. — An engine exerting $23\frac{1}{2}$ horses power by the indicator works two pairs of flour stones of 4 feet 8 inches diameter, two pair of stones grinding oatmeal of 4 feet 8 inches diameter, one dressing machine, one pair of fanners, one dust screen, and one sifting machine. One of the flour stones makes 85, and the other 90 revolutions in the minute. One of the oatmeal stones makes 120, and the other 140 revolutions in the minute. To take another case : — An engine exerting $26\frac{1}{2}$ indicator horse power works two pairs of flour stones, one dressing machine, two pairs of

500 POWER REQUIRED FOR GRINDING CORN.

stones grinding oatmeal, and one pair of shelling stones. The flour stones, one pair of the oatmeal stones, and shelling stones, are 4 feet 8 inches diameter. The diameter of the other pair of oatmeal stones is 3 feet 8 inches. The length of the cylinder of the dressing machine is 7 feet 6 inches. The flour stones make 87 revolutions in the minute, and the larger oatmeal stone 111 revolutions, but the smaller oatmeal stone and the shelling stone revolve faster than this. At the time the indicator diagram was taken, each pair of flour stones was grinding at the rate of 5 bushels an hour; each pair of oatmeal stones about 24 bushels an hour; and the shelling stones were shelling at the rate of about 54 bushels an hour. The fanners and screen were also in operation.

696. Q.—Have you any other cases to enumerate?

A.—I may mention one in which the power of the same engine was increased by giving it a larger supply of steam. The engine when working with 8.65 horses power, gives motion to one pair of oatmeal stones of 4 feet 6 inches diameter, and one pair of flour stones 4 feet 8 inches diameter. The oatmeal stone makes 100 revolutions in the minute, and the flour stone 89. The oatmeal stones grind about 36 bushels in the hour, and the flour stones 5 bushels in the hour. The engine when working to 12 horses power drives one pair of flour stones, 4 feet 8 inches diameter, at 89 revolutions per minute, and one pair of stones of the same diameter at 105 revolutions, grinding beans for cattle. The flour mill stones with this proportion of power, being more largely fed,

ground 6 bushels per hour, and the other stones also ground 6 bushels per hour. When the power was increased to 18 horses, and the engine was burdened in addition with a dressing machine having a cylinder of 19 inches diameter, the speed of the flour stone fell to 85, and of the beans stone to 100 revolutions per minute, and the yield was also reduced. The dressing machine dressed 24 bushels per hour.

697. Q.—What is the power necessary to work a sugar mill such as is used to press the juice from canes in the West Indies?

A.—Twenty horses power will work a sugar mill having rollers about 5 feet long and 28 inches diameter; the rollers making $2\frac{1}{2}$ turns in a minute. If the rollers be 26 inches diameter and $4\frac{1}{2}$ feet long, 18 horses power will suffice to work them at the same speed, and 16 horses power if the length be reduced to 3 feet 8 inches. 12 horses power will be required to work a sugar mill with rollers 24 inches diameter and 4 feet 2 inches long; and 10 horses power will suffice if the rollers be 3 feet 10 inches long and 23 inches diameter. The speed of the surface of sugar mill rollers should not be greater than 16 feet per minute, to allow time for the canes to part with their juice. In the old mills the speed was invariably too great. The quantity of juice expressed will not be increased by increasing the speed of the rollers, but more of the juice will pass away in the begass or woody refuse of the cane.

698. Q.—What is the amount of power necessary to drive cotton mills?

A.—An indicator or actual horse power will drive

305 hand mule spindles, with proportion of preparing machinery for the same; or 230 self-acting mule spindles with preparation; or 104 throstle spindles with preparation; or $10\frac{1}{2}$ power looms with common sizing. The throstles referred to are the common throstles spinning 34's twist for power loom weaving, and the spindles make 4000 turns per minute. The self acting mules are Roberts', about one half spinning 36's weft, and spindles revolving 4800 turns per minute; and the other half spinning 36's twist, with the spindles revolving 5200 times per minute. Half the hand mules were spinning 36's weft, at 4700 revolutions, and the other half 36's twist at 5000 revolutions per minute. The average breadth of the looms was 37 inches, weaving 37 inch cloth, making 123 picks per minute,—all common calicoes about 60 reed, Stockport count, and 68 picks to the inch. To take another example in the case of a mill for twisting cotton yarn into thread:—In this mill there are 27 frames with 96 common throstle spindles in each, making in all 2592 spindles. The spindles turn 2200 times in a minute; the bobbins are $1\frac{1}{4}$ inches diameter, and the part which holds the thread is $2\frac{3}{16}$ inches long. In addition to the twisting frames the steam engine works 4 turning lathes, 3 polishing lathes, 2 American machines for turning small bobbins, two circular saws one of 22 and the other of 14 inches diameter, and 24 bobbin heads or machines for filling the bobbins with finished thread. The power required to drive the whole of this machinery is $28\frac{1}{2}$ horses. When all the machinery except the spindles is thrown off, the power required is 21 horses,

so that 2592, the total number of spindles, divided by 21, the total power, is the number of twisting spindles worked by each actual horse power. The number is 122.84.

699. Q.—What work will be done by a given engine in sawing timber, pressing cotton, blowing furnaces, driving piles, and dredging earth out of rivers?

A.—A high pressure cylinder 10 inches diameter, 4 feet stroke, making 35 revolutions with steam of 90 to 100 lbs. on the square inch, supplied by three cylindrical boilers 30 inches diameter and 20 feet long, works two vertical saws of 34 inches stroke, which are capable of cutting 30 feet of yellow pine, 18 inches deep, in the minute. A high pressure cylinder 14 inches diameter and 4 feet stroke, making 60 strokes per minute with steam of 40 lbs. on the square inch, supplied by three cylindrical boilers without flues, 30 inches diameter and 26 feet long, with 32 square feet of grate surface, works four cotton presses geared 6 to 1, with two screws in each of $7\frac{1}{2}$ inches diameter and $1\frac{1}{2}$ pitch, which presses will screw 1000 bales of cotton in the twelve hours. Also one high pressure cylinder of 10 inches diameter and 3 feet stroke, making 45 to 60 revolutions per minute, with steam of 45 to 50 lbs. per square inch, with two hydraulic presses having 12 inch rams of $4\frac{1}{2}$ feet stroke, and force pumps 2 inches diameter and 6 inches stroke, presses 30 bales of cotton per hour. One condensing engine with cylinder 56 inches diameter, 10 feet stroke, and making 15 strokes per minute with steam of 60 lbs. pressure per square inch, cut off at $\frac{1}{2}$ th of

the stroke, supplied by six boilers, each 5 feet diameter, and 24 feet long, with a 22-inch double-return flue in each, and 198 square feet of fire grate, works a blast cylinder of 126 inches diameter, and 10 feet stroke, at 15 strokes per minute. The pressure of the blast is 4 to 5 lbs. per square inch; the area of pipes 2800 square inches, and the engine blows four furnaces of 14 feet diameter, each making 100 tons of pig iron per week. Two high pressure cylinders, each of 6 inches diameter and 18 inches stroke, making 60 to 80 strokes per minute, with steam of 60 lbs. per square inch, lift two rams, each weighing 1000 lbs., five times in a minute, the leaders for the lift being 24 feet long. One high pressure cylinder of 12 inches diameter and 5 feet stroke, making 20 strokes per minute, with steam of 60 to 70 lbs. pressure per square inch, lifts 6 buckets full of dredging per minute from a depth of 30 feet below the water, or lifts 10 buckets full of mud per minute from a depth of 18 feet below the water

CHAP. XII.

MANUFACTURE AND MANAGEMENT OF STEAM
ENGINES.

CONSTRUCTION OF ENGINES.

700. *Q.*—What are the qualities which should be possessed by the iron of which the cylinders of steam engines are made?

A.—The general ambition in making cylinders is to make them sound and hard; but it is expedient also to make them tough, so as to approach as nearly as possible to the state of malleable iron. This may be done by mixing in the furnace as many different kinds of iron as possible; and it may be set down as a general rule in iron founding, that the greater the number of the kinds of metal entering into the composition of any casting, the denser and tougher it will be. The constituent atoms of the different kinds of iron appear to be of different sizes, and the mixture of different kinds maintains the toughness, while it adds to the density and cohesive power. Hot blast iron was at one time generally believed to be weaker than cold blast iron, but it is now questioned whether it is not the stronger of the two. The cohesive

strength of unmixed iron is not in proportion to its specific gravity, and its elasticity and power to resist shocks appears to become greater as the specific gravity becomes less. Nos. 3. and 4. are the strongest irons. In most cases, iron melted in a cupola is not so strong as when remelted in an air furnace, and when run into green sand it is not reckoned so strong as when run into dry sand, or loam. The quality of the fuel, and even the state of the weather, exerts an influence on the quality of the iron: smelting furnaces, on the cold blast principle, have long been known to yield better iron in winter than in summer, probably from the existence of less moisture in the air; and it would probably be found to accomplish an improvement in the quality of the iron if the blast were made to pass through a vessel containing muriate of lime, by which the moisture of the air would be extracted. The expense of such a preparation would not be considerable, as, by subsequent evaporation, the salt might be used over and over again for the same purpose.

701. Q.— Will you explain the process of casting cylinders?

A.— The mould into which the metal is poured is built up of bricks and loam, the loam being clay and sand ground together in a mill, with the addition of a little horsedung to give it a fibrous structure and prevent cracks. The loam board, by which the circle of the cylinder is to be swept, is attached to an upright iron bar, at the distance of the radius of the cylinder, and a cylindrical shell of brick is built up, which is plastered on the inside with loam, and made

quite smooth by traversing the perpendicular loam board round it. A core is then formed in a similar manner, but so much smaller as to leave a space between the shell and the core equal to the thickness of the cylinder, and into this space the melted metal is poured. Whatever nozzles or projections are required upon the cylinder, must be formed by means of wooden patterns, which are built into the shell, and subsequently withdrawn; but where a number of cylinders of the same kind are required, it is advisable to make these patterns of iron, which will not be liable to warp or twist while the loam is being dried. Before the iron is cast into the mould, the interior of the mould must be covered with finely powdered charcoal — or blackening, as it is technically termed; and the secret of making finely skinned castings lies in using plenty of blackening. In loam and dry sand castings the charcoal should be mixed with thick clay water, and applied until it is an eighth of an inch thick, or more; the surface should be then very carefully smoothed or sleeked, and if the metal has been judiciously mixed, and the mould thoroughly dried, the casting is sure to be a fine one. Dry sand and loam castings should be, as much as possible, made in boxes; the moulds may thereby be more rapidly and more effectually dried, and better castings will be got with a less expense.

702. Q. — Will you explain the next operation which a cylinder undergoes?

A. — The next stage is the boring; and in boring cylinders of 74 inches diameter, the boring bar must move so as to make one revolution in about $4\frac{1}{2}$

minutes, at which speed the cutters will move at the rate of about 5 feet per minute. In boring brass, the speed must be slower; the common rate at which the tool moves in boring brass air pumps is about 3 feet per minute. If this speed be materially exceeded the tool will be spoiled, and the pump made taper. The speed proper for boring a cylinder will answer for boring the brass air pump of the same engine. A brass air pump of $36\frac{1}{2}$ inches diameter requires the bar to make one turn in about three minutes, which is also the speed proper for a cylinder 60 inches in diameter. To bore a brass air pump $36\frac{1}{2}$ inches in diameter requires a week, an iron one requires 48 hours, and a copper one 24 hours. In turning a malleable iron shaft $12\frac{3}{4}$ inches in diameter, the shaft should make about five turns per minute, which is equivalent to a speed in the tool of about 16 feet per minute; but this speed may be exceeded if soap and water be plentifully run on the point of the tool. A boring mill, of which the speed may be varied from one turn in six minutes to twenty-five turns in one minute, will be suitable for all ordinary wants that can occur in practice.

703. Q. — Are there any precautions necessary to be observed in order that the boring may be truly effected?

A. — In fixing a cylinder into the boring mill, great care must be taken that it is not screwed down unequally; and indeed it will be impossible to bore a large cylinder in a horizontal mill without being oval, unless the cylinder be carefully gauged when standing on end, and be set up by screws when laid in the mill

until it again assumes its original form. A large cylinder will inevitably become oval if laid upon its side; and if while under the tension due to its own weight it be bored round, it will become oval again when set upon end. If the bottom be cast in, the cylinder will be probably found to be round at one end and oval at the other, unless a vertical boring mill be employed, or the precautions here suggested be adopted.

704. Q. — Does the boring tool make the cylinder sufficiently smooth for the reception of the piston?

A. — Many engine makers give no other finish to their cylinders; but Messrs. Penn grind their cylinders after they are bored, by laying them on their side, and rubbing a piece of lead, with a cross iron handle like that of a rolling stone, and smeared with emery and oil, backwards and forwards — the cylinder being gradually turned round so as to subject every part successively to the operation. The lead by which this grinding is accomplished is cast in the cylinder, whereby it is formed of the right curve; but the part of the cylinder in which it is cast should be previously heated by a hot iron, else the metal may be cracked by the sudden heat.

705. Q. — How are the parts of a piston fitted together so as to be perfectly steam tight?

A. — The old practice was to depend chiefly upon grinding as the means of making the rings tight upon the piston or upon one another; but scraping is now chiefly relied on. Some makers, however, finish their steam surfaces by grinding them with powdered Turkey stone and oil. A slight grinding, or polish-

ing, with powdered Turkey stone and oil, appears to be expedient in ordinary cases, and may be conveniently accomplished by setting the piston on a revolving table, and holding the ring stationary by a cross piece of wood while the table turns round. Pieces of wood may be interposed between the ring and the body of the piston, to keep the ring nearly in its right position; but these pieces of wood should be fitted so loosely as to give some side play, else the disposition would arise to wear the flange of the piston into a groove.

706. Q.—What kind of tool is used for finishing surfaces by scraping?

A.—A flat file bent, and sharpened at the end, makes an eligible scraper for the first stages; or a flat file sharpened at the end and used like a chisel for wood. A three-cornered file, sharpened at all the corners, is the best instrument for finishing the operation. The scraping tool should be of the best steel, and should be carefully sharpened at short intervals on a Turkey stone, so as to maintain a fine edge.

707. Q.—Will you explain the method of fitting together the valve and cylinder faces?

A.—Both faces must first be planed, then filed according to the indications of a metallic straight edge, and subsequently of a thick metallic face plate, and finally scraped very carefully until the face plate bears equally all over the surface. In planing any surface, the catches which retain the surface on the planing machine should be relaxed previously to the last cut, to obviate distortion from springing. To ascertain whether the face plate bears equally, smear it over with a little red ochre and oil, and move the face plate slightly,

which will fix the colour upon the prominent points. This operation is to be repeated frequently ; and as the work advances, the quantity of colouring matter is to be diminished, until finally it is spread over the face plate in a thin film, which only dims the brightness of the plate. The surfaces at this stage must be rubbed firmly together to make the points of contact visible, and the higher points will become slightly clouded, while the other parts are left more or less in shade. If too small a quantity of colouring matter be used at first, it will be difficult to form a just conception of the general state of the surface, as the prominent points will alone be indicated, whereas the use of a large quantity of colouring matter in the latter stages would destroy the delicacy of the test the face plate affords. The number of bearing points which it is desirable to establish on the surface of the work, depends on the use to which the surface is to be applied ; but whether it is to be finished with great elaboration, or otherwise, the bearing points should be distributed equally over the surface. Face plates, or planometers, as they are sometimes termed, are supplied by most of the makers of engineering tools. Every factory should be abundantly supplied with them, and also with steel straight edges ; and there should be a master face plate, and a master straight edge, for the sole purpose of testing, from time to time, the accuracy of those in use.

708. Q. — Is the operation of surfacing, which you have described, necessary in the case of all slide valves?

A. — Yes ; and in fitting the faces of a D valve,

great care must, in addition, be taken that the valve is not made conical ; for unless the back be exactly parallel with the face, it will be impossible to keep the packing from being rapidly cut away. When the valve is laid upon the face plate, the back must be made quite fair along the whole length, by draw filing, according to the indications of a straight edge ; and the distance from the face to the extreme height of the back must be made identical at each extremity.

709. Q.—When you described the operation of boring the cylinder, you stated that the cylinder, when laid upon its side, became oval ; will not this change of figure distort the cylinder face ?

A.—It is not only in the boring of the cylinder that it is necessary to be careful that there is no change of figure, for it will be impossible to face the valves truly in the case of large cylinders, unless the cylinder be placed on end, or internal props be introduced to prevent the collapse due to the cylinder's weight. It may be added, that the change of figure is not instantaneous, but becomes greater after some continuance of the strain than it was at first, so that in gauging a cylinder to ascertain the difference of diameter when it is placed on its side, it should have lain some days upon its side to ensure the accuracy of the operation.

710. Q.—How is any flaw in the valve or cylinder face remedied ?

A.—Should a hole occur either in the valve, in the cylinder, or any other part where the surface requires to be smooth, it may be plugged up with a piece of

cast iron, as nearly as possible of the same texture. Bore out the faulty part, and afterwards widen the hole with an eccentric drill, so that it will be of the least diameter at the mouth. The hole may go more than half through the iron: fit then a plug of cast iron roughly by filing, and hammer it into the hole, whereby the plug will become riveted in it, and its surface may then be filed smooth. Square pieces may be let in after the same fashion, the hole being made dovetailed, and the pieces thus fitted will never come out.

711. Q.—When cylinders are faced with brass, how is the face attached to the cylinder?

A.—Brass faces are put upon valves or cylinders by means of small brass screws tapped into the iron, with conical necks for the retention of the brass: they are screwed by means of a square head, which, when the screw is in its place, is cut off and filed smooth. In some cases the face is made of extra thickness, and a rim not so thick runs round it, forming a step or recess for the reception of brass rivets, the heads of which are clear of the face.

712. Q.—What is the best material for valve faces?

A.—Much trouble is experienced with every modification of valve face; but cast iron working upon cast iron is, perhaps, the best combination yet introduced. A usual practice is to pin brass faces on the cylinder, allowing the valve to retain its cast iron face. Some makers employ brass valves, and others pin brass on the valves, leaving the cylinder with a cast iron face. If brass valves are used, it is advis-

able to plane out two grooves across the face, and to fill them up with hard cast iron to prevent rutting. Speculum metal and steel have been tried for the cylinder faces, but only with moderate success. In some cases the brass gets into ruts; but the most prevalent affection is a degradation of the iron, owing to the action of the steam, and the face assuming a granular appearance, something like loaf sugar. This action shows itself only at particular spots, and chiefly about the angles of the port or valve face. At first the action is slow; but when once the steam has worked a passage for itself, the cutting away becomes very rapid, and, in a short time, it will be impossible to prevent the engine from heating when stopped, owing to the leakage of steam through the valve into the condenser. Copper steam pipes seem to have some galvanic action on valve faces, and malleable iron pipes have sometimes been substituted; but they are speedily worn out by oxidation, and the scales of rust which are carried on by the steam scratch the valves and cylinders, so that the use of copper pipes is the least evil.

713. Q. — Will you explain in what manner the joints of an engine are made?

A. — Rust joints are not now much used in engines of any kind, yet it is necessary that the engineer should be acquainted with the manner of their formation. One ounce of sal-ammoniac in powder is mingled with 18 ounces or a pound of borings of cast iron, and a sufficiency of water is added to wet the mixture thoroughly, which should be done some hours before it is wanted for use. Some persons add about half an

ounce of flowers of brimstone to the above proportions, and a little sludge from the grindstone trough. This cement is caulked into the joints with a caulking iron, about three quarters of an inch wide and one quarter of an inch thick, and after the caulking is finished the bolts of the joints may be tried to see if they cannot be further tightened. The skin of the iron must, in all cases, be broken where a rust joint is to be made; and, if the place be greasy, the surface must be well rubbed over with nitric acid, and then washed with water, till no grease remains. The oil about engines has a tendency to damage rust joints by recovering the oxide. Coppersmiths staunch the edges of their plates and rivets by means of a cement formed of pounded quicklime, with serum of blood, or white of egg; and in copper boilers such a substance may be useful in stopping the impalpable leaks which sometimes occur, though Roman cement appears to be nearly as effectual.

714. Q.— Will you explain the method of case hardening the parts of engines?

A.— The most common plan for case hardening consists in the insertion of the articles to be operated upon among horn or leather cuttings, bone dust, or animal charcoal, in an iron box provided with a tight lid, which is then put into a furnace for a period answerable to the depth of steel required. In some cases the plan pursued by the gunsmiths may be employed with convenience. The article is inserted in a sheet iron case amid bone dust, often not burned; the lid of the box is tied on with wire, and the joint luted with clay; the box is heated to redness as

quickly as possible and kept half an hour at a uniform heat: its contents are then suddenly immersed in cold water. The more unwieldy portions of an engine may be case hardened by prussiate of potash — a salt made from animal substances, composed of two atoms of carbon and one of nitrogen, and which operates on the same principle as the charcoal. The iron is heated in the fire to a dull red heat, and the salt is either sprinkled upon it or rubbed on in a lump, or the iron is rubbed in the salt in powder. The iron is then returned to the fire for a few minutes, and finally immersed in water. By some persons the salt is supposed to act unequally, as if there were greasy spots upon the iron which the salt refused to touch, and the effect under any circumstances is exceedingly superficial; nevertheless, upon all parts not exposed to wear, a sufficient coating of steel may be obtained by this process.

715. Q.—What kind of iron is most suitable for the working parts of an engine?

A.—In the malleable iron work of engines scrap iron has long been used, and considered preferable to other kinds; but if the parts are to be case hardened, as is now the usual practice, the use of scrap iron is to be reprehended, as it is almost sure to make the parts twist in the case hardening process. In case hardening, iron absorbs carbon, which causes it to swell; and as some kinds of iron have a greater capacity for carbon than other kinds, in case hardening they will swell more, and any such unequal enlargement in the constituent portions of a piece of iron will cause it to change its figure. In some cases, case

hardening has caused such a twisting of the parts of an engine, that they could not afterwards be fitted together; it is preferable, therefore, to make such parts as are to be case hardened to any considerable depth of Lowmoor, Bowling, or Indian iron, which being homogeneous will absorb carbon equally, and will not twist.

716. Q.—What is the composition of the brass used for engine bearings?

A.—The brass bearings of an engine are composed principally of copper and tin. A very good brass for steam engine bearings consists of old copper 112 lbs., tin $12\frac{1}{2}$ lbs., zinc 2 or 3 oz.; and if new tile copper be used, there should be 13 lbs. of tin instead of $12\frac{1}{2}$ lbs. A tough brass for engine work consists of $1\frac{1}{2}$ lb. tin, $1\frac{1}{2}$ lb. zinc, and 10 lbs. copper; a brass for heavy bearings, $2\frac{1}{2}$ oz. tin, $\frac{1}{2}$ oz. zinc, and 1 lb. copper. There is a great difference in the length of time brasses wear, as made by different manufacturers; but the difference arises as much from a different quantity of surface, as from a varying composition of the metal. Brasses should always be made strong and thick, as when thin they collapse upon the bearing and increase the friction and the wear.

717. Q.—How is Babbitt's metal for lining the bushes of machinery compounded?

A.—Babbitt's patent lining metal for bushes has been largely employed in the bushes of locomotive axles and other machinery: it is composed of 1 lb. of copper, 1 lb. regulus of antimony, and 10 lbs. of tin, or other similar proportions, the presence of tin being the only material condition. The copper is first

melted, then the antimony is added, with a small portion of tin — charcoal being strewed over the surface of the metal in the crucible to prevent oxidation. The bush or article to be lined, having been cast with a recess for the soft metal, is to be fitted to an iron mould, formed of the shape and size of the bearing or journal, allowing a little in size for the shrinkage. Drill a hole for the reception of the soft metal, say $\frac{1}{4}$ to $\frac{3}{8}$ inch diameter, wash the parts not to be tinned with a clay wash to prevent the adhesion of the tin, wet the part to be tinned with alcohol, and sprinkle fine sal-ammoniac upon it; heat the article until fumes arise from the ammonia, and immerse it in a kettle of Banca tin, care being taken to prevent oxidation. When sufficiently tinned, the bush should be soaked in water, to take off any particles of ammonia that may remain upon it, as the ammonia would cause the metal to blow. Wash with pipe clay, and dry; then heat the bush to the melting point of tin, wipe it clean, and pour in the metal, giving it sufficient head as it cools; the bush should then be scoured with fine sand, to take off any dirt that may remain upon it, and it is then fit for use. This metal wears for a longer time than ordinary gun metal, and its use is attended with very little friction. If the bearing heats, however, from the stopping of the oil hole or otherwise, the metal will be melted out. A metallic grease, containing particles of tin in the state of an impalpable powder, would probably be preferable to the lining of metal just described.

718. Q. — Can you state the composition of any other alloys that are used in engine work?

A. — The ordinary range of good yellow brass that files and turns well, is about $4\frac{1}{2}$ to 9 ounces of zinc to the pound of copper. Flanges to stand brazing may be made of copper 1 lb., zinc $\frac{1}{2}$ oz., lead $\frac{3}{8}$ oz. Brazing solders when stated in the order of their hardness are: — three parts copper and one part zinc (very hard), eight parts brass and one part zinc (hard), six parts brass, one part tin, and one part zinc (soft); a very common solder for iron, copper, and brass, consists of nearly equal parts of copper and zinc. Muntz's metal consists of forty parts zinc and sixty of copper: any proportions between the extremes of fifty parts of zinc and fifty parts copper, and thirty-seven zinc and sixty-three copper, will roll and work at a red heat, but forty zinc to sixty copper are the proportions preferred. Bell metal, such as is used for large bells, consists of $4\frac{1}{2}$ ounces to 5 ounces of tin to the pound of copper; speculum metal consists of from $7\frac{1}{2}$ ounces to $8\frac{1}{2}$ ounces of tin to the pound of copper.

ERECTION OF ENGINES.

719. *Q.* — Will you explain the operation of erecting a pair of side lever engines in the workshop?

A. — In beginning the erection of side lever marine engines in the workshop, the first step is to level the bed plate lengthways and across, and strike a line up the centre, as near as possible in the middle, which indent with a chisel in various places, so that it may at any time be easily found again. Strike another line at right angles with this, either at the cylinder or crank centre, by drawing a perpendicular in the usual

manner. Lay the other sole plate alongside at the right distance, and strike a line at the cylinder or crank centre of it also, shifting either sole plate a little endways until these two transverse lines come into the same line, which may be ascertained by applying a straight edge across the two sole plates. Strike the rest of the centres across, and drive a pin into each corner of each sole plate, which file down level, so as to serve for points of reference at any future stage; next, try the cylinder, or plumb it on the inside roughly, and see how it is for height, in order to ascertain whether much will be required to be chipped off the bottom, or whether more requires to be chipped off the one side than the other. Chip the cylinder bottom fair; set it in its place, plumb the cylinder very carefully with a straight edge and silk thread, and scribe it so as to bring the cylinder mouth to the right height, then chip the sole plate to suit that height. The cylinder must then be tried on again, and the parts filed wherever they bear hard, until the whole surface is well fitted. Next, chip the place for the framing; set up the framing, and scribe the horizontal part of the jaw with the scriber used for the bottom of the cylinder, the upright part being set to suit the shaft centres, and the angular flange of cylinder, where the stay is attached, having been previously chipped plumb and level. The stake wedges with which the framing is set up preparatorily to the operation of scribing, must be set so as to support equally the superincumbent weight, else the framing will spring from resting unequally, and it will be altogether impossible to fit it well. These directions ob-

viously refer exclusively to the old description of side lever engine with cast iron framing; but there is more art in erecting an engine of that kind with accuracy, than in erecting one of the direct action engines, where it is chiefly turned or bored surfaces that have to be dealt with.

720. *Q.*—How do you lay out the positions of the centres of a side lever engine?

A.—In fixing the positions of the centres in side lever engines, it appears to be the most convenient way to begin with the main centre. The height of the centre of the cross head at half stroke above the plane of the main centre is fixed by the drawing of the engine, which gives the distance from the centre of cross head at half stroke to the flange of the cylinder; and from thence it is easy to find the perpendicular distance from the cylinder flange to the plane of the main centre, merely by putting a straight edge along level, from the position of the main centre to the cylinder, and measuring from the cylinder flange down to it, raising or lowering the straight edge until it rests at the proper measurement. The main centre is in that plane, and the fore and aft position is to be found by plumbing up from the centre line on the sole plate. To find the paddle shaft centre, plumb up from the centre line marked on the edge of the sole plate, and on this line lay off from the plane of the main centre the length of the connecting rod, if that length be already fixed, or otherwise the height fixed in the drawing of the paddle shaft above the main centre. To fix the centre for the parallel motion shaft, when the parallel bars are connected with the cross head,

lay off from the plane of main centre the length of the parallel bar from the centre of the cylinder, deduct the length of the radius crank, and plumb up the central line of motion shaft; lay off on this line, measuring from the plane of main centre, the length of the side rod; this gives the centre of parallel motion shaft when the radius bars join the cross head, as is the preferable practice where parallel motions are used. The length of the connecting rod is the distance from the centre of the beam when level, or the plane of the main centre, to the centre of the paddle shaft. The length of the side rods is the distance from the centre line of the beam when level, to the centre of the cross head when the piston is at half stroke. The length of the radius rods of the parallel motion is the distance from the point of attachment on the cross head or side rod, when the piston is at half stroke, to the extremity of the radius crank when the crank is horizontal; or in engines with the parallel motion attached to the cross head, it is the distance from the centre of the pin of the radius crank when horizontal to the centre of the cylinder. Having fixed the centre of the parallel motion shaft in the manner just described, it only remains to put the parts together when the motion is attached to the cross head; but when the motion is attached to the side rod, the end of the parallel bar must not move in a perpendicular line, but in an arc, the versed sine of which bears the same ratio to that of the side lever, that the distance from the top of the side rod to the point of attachment bears to the total length of the side rod.

721. *Q.*—How do you ascertain the accuracy of the parallel motion?

A.—The parallel motion when put in its place should be tested by raising and lowering the piston by means of the crane. First, set the beams level, and shift in or out the motion shaft plummer blocks or bearings, until the piston rod is upright. Then move the piston to the two extremes of its motion. If at both ends the cross head is thrown too much out, the stud in the beam to which the motion side rod is attached is too far out, and must be shifted nearer to the main centre; if at the extremities the cross head is thrown too far in, the stud in the beam is not out far enough. If the cross head be thrown in at the one end, and out equally at the other, the fault is in the motion side rod, which must be lengthened or shortened to remedy the defect.

722. *Q.*—Will you describe the method pursued in erecting oscillating engines?

A.—The columns here are of wrought iron, and in the case of small engines there is a template made of wood and sheet iron, in which the holes are set in the proper positions, by which the upper and lower frames are adjusted; but in the case of large engines, the holes are set off by means of trammels. The holes for the reception of the columns are cast in the frames, and are recessed out internally: the bosses encircling the holes are made quite level across, and made very true with a face plate, and the pillars which have been turned to a gauge are then inserted. The top frame is next put on, and must bear upon the collars of the columns so evenly, that one of the columns will not

be bound by it harder than another. If this point be not attained, the surfaces must be further scraped, until a perfect fit is established. The whole of the bearings in the best oscillating engines are fitted by means of scraping, and on no other mode of fitting can the same reliance be placed for exactitude.

723. Q. — How do you set out the trunnions of oscillating engines, so that they shall be at right angles with the interior of the cylinder?

A. — Having bored the cylinder, faced the flange, and bored out the hole through which the boring bar passes, put a piece of wood across the mouth of the cylinder, and jam it in, and put a similar piece in the hole through the bottom of the cylinder. Mark the centre of the cylinder upon each of these pieces, and put into the bore of each trunnion an iron plate, with a small indentation in the middle to receive the centre of a lathe, and adjusting screws to bring the centre into any required position. The cylinder must then be set in a lathe, and hung by the centres of the trunnions, and a straight edge must be put across the cylinder mouth and levelled, so as to pass through the line in which the centre of the cylinder lies. Another similar straight edge, and similarly levelled, must be similarly placed across the cylinder bottom, so as to pass through the central line of the cylinder; and the cylinder is then to be turned round in the trunnion centres—the straight edges remaining stationary, which will at once show whether the trunnions are in the same horizontal plane as the centre of the cylinder, and if not, the screws of the plates in the trunnions must be adjusted until the central point of the cylinder

just comes to the straight edge, whichever end of the cylinder is presented. To ascertain whether the trunnions stand in a transverse plane, parallel to the cylinder flange, it is only necessary to measure down from the flange to each trunnion centre; and if both these conditions are satisfied, the position of the centres may be supposed to be right. The trunnion bearings are then turned, and are fitted into blocks of wood, in which they run while the packing space is being turned out. Where many oscillating engines are made, a lathe with four centres is used, which makes the use of straight edges in setting out the trunnions superfluous.

724. Q. — Will you explain how the slide valve of a marine engine is set ?

A. — Place the crank in the position corresponding to the end of the stroke, which can easily be done in the shop with a level, or plumb line; but in a steam vessel another method becomes necessary. Draw the transverse centre line, answering to the centre line of the crank shaft, on the sole plate of the engine, or on the cylinder mouth if the engine be of the direct action kind; describe a circle of the diameter of the crank pin upon the large eye of the crank, and mark off on either side of the transverse centre line a distance equal to the semi-diameter of the crank pin. From the point thus found, stretch a line to the edge of the circle described on the large eye of the crank, and bring round the crank shaft till the crank pin touches the stretched line; the crank may thus be set at either end of its stroke. When the crank is thus placed at the end of the stroke, the valve must be adjusted so as

to have the amount of lead, or opening on the steam side, which it is intended to give at the beginning of the stroke; the eccentric must then be turned round upon the shaft until the notch in the eccentric rod comes opposite the pin on the valve lever, and falls into gear: mark upon the shaft the situation of the eccentric, and put on the catches in the usual way. The same process must be repeated for going astern, shifting round the eccentric to the opposite side of the shaft, until the rod again falls into gear. In setting valves, regard must of course be had to the kind of engine, the arrangement of the levers, and the kind of valve employed; and in any general instructions it is impossible to specify every modification in the procedure that circumstances may render advisable.

725. Q.— Is a similar method of setting the valve adopted when the link motion is employed.

A. — Each end of the link of the link motion has the kind of motion communicated to it that is due to the action of the particular eccentric with which that end is in connection. In that form of the link motion in which the link itself is moved up or down, there is a different amount of lead for each different position of the link, since to raise or lower the link is tantamount to turning the eccentric round on the shaft. In that form of the link motion in which the link itself is not raised or lowered, but is susceptible of a motion round a centre in the manner of a double ended lever, the lead continues uniform. In both forms of the link motion, as the stroke of the valve may be varied to any required extent while the lap is a constant quantity, the proportion of the lap relatively to the stroke

of the valve may also be varied to any required extent, and the amount of the lap relatively with the stroke of the valve determines the amount of the expansion. In setting the valve when fitted with the link motion, the mode of procedure is much the same as when it is moved by a simple eccentric. The first thing is to determine if the eccentric rods are of the proper length, and this is done by setting the valve at half stroke and turning round the eccentric, marking each extremity of the travel of the end of the rod. The valve attachment should be midway between these extremes; and if it is not so, it must be made so by lengthening or shortening the rod. The forward and backward eccentric rods are to be adjusted in this way, and this being done, the engine is to be put to the end of the stroke, and the eccentric is to be turned round until the amount of lead has been given that is desired. The valve must be tried by turning the engine round to see that it is right at both centres, for going ahead and also for going astern. In some examples of the link motion, one of the eccentric rods is made a little longer than the other, and the position of the point of suspension or point of support powerfully influences the action of the link in certain cases, especially if the link and this point are not in the same vertical line. To reconcile all the conditions proper to the satisfactory operation of the valve in the construction of the link motion, is a problem requiring a good deal of attention and care for its satisfactory solution; and to make sure that this result is attained, the engine must be turned round a sufficient number of times to enable us to ascertain if the valve occupies

the desired position, both at the top and bottom centres, whether the engine is going ahead or astern. This should also be tried with the starting handle in the different notches, or, in other words, with the sliding block in the slot or opening of the link in different positions.

MANAGEMENT OF MARINE BOILERS.

726. Q. — You have already stated that the formation of salt or scale in marine boilers is to be prevented by blowing out into the sea at frequent intervals a portion of the concentrated water. Will you now explain how the proper quantity of water to be blown out is determined?

A. — By means of the salinometer, which is an instrument for determining the density of the water, constructed on the principle of the hydrometer for telling the strength of spirits. Some of the water is drawn off from the boiler from time to time, and the salinometer is immersed in it after it has been cooled. By the graduations of the salinometer the saltiness of this water is at once discovered; and if the saltiness exceeds 8 ounces of salt in the gallon, more water should be blown out of the boiler to be replenished with fresher water from the sea, until the prescribed limit of freshness is attained. Should the salinometer be accidentally broken, a temporary one may be constructed of a phial weighted with a few grains of shot or other convenient weight. The weighted phial is first to be floated in fresh water, and its line of float-

tion marked ; then to be floated in salt water, and its line of floatation marked ; and another mark of an equal height above the salt water mark will be the blow off point.

727. Q.—How often should boilers be blown off in order to keep them free from incrustation ?

A.—Flue boilers generally require to be blown off about twice every watch, or about twice in the four hours ; but tubular boilers may require to be blown off once every twenty minutes, and such an amount of blowing off should in every case be adopted, as will effectually prevent any injurious amount of incrustation.

728. Q.—In the event of scale accumulating on the flues of a boiler, what is the best way of removing it ?

A.—If the boilers require to be scaled, the best method of performing the operation appears to be the following :—Lay a train of shavings along the flues, open the safety valve to prevent the existence of any pressure within the boiler, and light the train of shavings, which, by expanding rapidly the metal of the flues, while the scale, from its imperfect conducting power, can only expand slowly, will crack off the scale ; by washing down the flues with a hose, the scale will be carried to the bottom of the boiler, or issue, with the water, from the mud-hole doors. This method of scaling must be practised only by the engineer himself, and must not be entrusted to the firemen, who, in their ignorance, might damage the boiler by overheating the plates. It is only where the incrustation upon the flues is considerable that this method of removing it need be practised ; in partial

cases the scale may be chipped off by a hatchet-faced hammer, and the flues may then be washed down with the hose in the manner before described.

729. *Q.*—Should the steam be let out of the boiler, after it has blown out the water, when the engine is stopped?

A.—No; it is better to retain the steam in the boiler, as the heat and moisture it occasions softens any scale adhering to the boiler, and causes it to peel off. Care must, however, be taken not to form a vacuum in the boiler; and the gauge cocks, if opened, will prevent this.

730. *Q.*—Are tubular boilers liable to the formation of scale in certain places, though generally free from it?

A.—In tubular boilers a good deal of care is required to prevent the ends of the tubes next the furnace from becoming coated with scale. Even when the boiler is tolerably clean in other places the scale will collect here; and in many cases where the amount of blowing off previously found to suffice for flue boilers has been adopted, an incrustation five-eighths of an inch in thickness has formed in twelve months round the furnace ends of the tubes, and the stony husks enveloping them have actually grown together in some parts so as totally to exclude the water.

731. *Q.*—When a tubular boiler gets incrustated in the manner you have described, what is the best course to be adopted for the removal of the scale?

A.—When a boiler gets into this state the whole of the tubes must be pulled out, which may be done by a Spanish windlass combined with a pair of blocks; and

three men, when thus provided, will be able to draw out from 50 to 70 tubes per day,—those tubes with the thickest and firmest incrustations being, of course, the most difficult to remove. The act of drawing out the tubes removes the incrustation; but the tubes should afterwards be scraped by drawing them backwards and forwards between two old files, fixed in a vice, in the form of the letter V. The ends of the tubes should then be heated and dressed with the hammer, and plunged while at a blood heat into a bed of sawdust to make them cool soft, so that they may be riveted again with facility. A few of the tubes will be so far damaged at the ends by the act of drawing them out, as to be too short for reinsertion: this result might be to a considerable extent obviated by setting the tube plates at different angles, so that the several horizontal rows of tubes would not be originally of the same length, and the damaged tubes of the long rows would serve to replace the short ones; but the practice would be attended with other inconveniences.

732. Q.—Is there no other means of keeping boilers free from scale than by blowing off?

A.—Muriatic acid, or muriate of ammonia, commonly called sal-ammoniac, introduced into a boiler, prevents scale to a great extent; but it is liable to corrode the boiler internally, and also to damage the engine, by being carried over with the steam; and the use of such intermixtures does not appear to be necessary, if blowing off from the surface of the water is largely practised. In old boilers, however, already

incrusted with scale, the use of muriate of ammonia may sometimes be advantageous.

733. Q.—Are not the tubes of tubular boilers liable to be choked up by deposits of soot ?

A.—The soot which collects in the inside of the tubes of tubular boilers is removed by means of a brush, like a large bottle brush ; and the carbonaceous scale, which remains adhering to the interior of the tubes, is removed by a circular scraper. Ferules in the tubes interfere with the action of this scraper, and in the case of iron tubes ferules are now generally discarded ; but it will sometimes be necessary to use ferules for iron tubes, where the tubes have been drawn and reinserted, as it may be difficult to refix the tubes without such an auxiliary. Tubes one-tenth of an inch in thickness are too thin : one-eighth of an inch is a better thickness, and such tubes will better dispense with the use of ferules, and will not so soon wear into holes.

734. Q.—If the furnace or flue of a boiler be injured, how do you proceed to repair it ?

A.—If from any imperfection in the roof of a furnace or flue a patch requires to be put upon it, it will be better to let the patch be applied upon the upper, rather than upon the lower, surface of the plate ; as if applied within the furnace a recess will be formed for the lodgement of deposit, which will prevent the rapid transmission of the heat in that part ; and the iron will be very liable to be again burned away. A crack in a plate may be closed by boring holes in the direction of the crack, and inserting rivets with large heads, so as to cover up the im-

perfection. If the top of the furnace be bent down, from the boiler having been accidentally allowed to get short of water, it may be set up again by a screw jack,—a fire of wood having been previously made beneath the injured plate; but it will in general be nearly as expeditious a course to remove the plate and introduce a new one, and the result will be more satisfactory.

735. Q.—In the case of the chimney being carried away by shot or otherwise, what course would you pursue?

A.—In some cases of collision, the funnel is carried away and lost overboard, and such cases are among the most difficult for which a remedy can be sought. If flame come out of the chimney when the funnel is knocked away, so as to incur the risk of setting the ship on fire, the uptake of the boiler must be covered over with an iron plate, or be sufficiently covered to prevent such injury. A temporary chimney must then be made of such materials as are on board the ship. If there are bricks and clay or lime on board, a square chimney may be built with them, or, if there be sheet iron plates on board, a square chimney may be constructed of them. In the absence of such materials, the awning stanchions may be set up round the chimney, and chain rove in through among them in the manner of wicker work, so as to make an iron wicker chimney, which may then be plastered outside with wet ashes mixed with clay, flour, or any other material that will give the ashes cohesion. War steamers should carry short spare funnels, which may easily be set up should the original funnel be shot

away ; and if a jet of steam be let into the chimney, a very short and small funnel will suffice for the purpose of draught.

MANAGEMENT OF MARINE ENGINES.

736. Q.— What are the most important of the points which suggest themselves to you in connection with the management of marine engines?

A.— The attendants upon engines should prepare themselves for any casualty that may arise, by considering possible cases of derangement, and deciding in what way they would act should certain accidents occur. The course to be pursued must have reference to particular engines, and no general rules can therefore be given ; but every marine engineer should be prepared with the measures to be pursued in the emergencies in which he may be called upon to act, and where everything may depend upon his energy and decision.

737. Q.— What is the first point of a marine engineer's duty?

A.— The safe custody of the boiler. He must see that the feed is maintained, being neither too high nor too low, and that blowing out the supersalted water is practised sufficiently. The saltness of the water at every half hour should be entered in the log-book, together with the pressure of steam, number of revolutions of the engine, and any other particulars which have to be recorded. The economical use of the fuel is another matter which should receive particular attention. If the coal is very small, it

should be wetted before being put on the fire. Next to the safety of the boiler, the bearings of the engine are the most important consideration. These points, indeed, constitute the main parts of the duty of an engineer, supposing no accident to the machinery to have taken place.

738. *Q.*—If the eccentric catches or hoops were disabled, how would you work the valve?

A.—If the eccentric catches or hoops break or come off, and the damage cannot readily be repaired, the valve may be worked by attaching the end of the starting handle to any convenient part of the other engine, or to some part in connection with the connecting rod of the same engine. In side lever engines, with the starting bar hanging from the top of the diagonal stay, as is a very common arrangement, the valve might be wrought by leading a rope from the side lever of the other engine through blocks, so as to give a horizontal pull to the hanging starting bar, and the bar could be brought back by a weight. Another plan would be, to lash a piece of wood to the cross tail butt of the damaged engine, so as to obtain a sufficient throw for working the valve, and then to lead a piece of wood or iron, from a suitable point in the piece of wood attached to the cross tail, to the starting handle, whereby the valve would receive its proper motion. In oscillating engines it is easy to give the required motion to the valve, by deriving it from the oscillation of the cylinder.

739. *Q.*—What would you do if a crank pin broke?

A.—If the crank pin breaks in a paddle vessel

with two engines, the other engine must be made to work one wheel. In a screw vessel the same course may be pursued, provided the broken crank is not the one through which the force of the other engine is communicated to the screw. In such a case the vessel will be as much disabled as if she broke the screw shaft or screw.

740. Q.—Will the unbroken engine, in the case of disarrangement of one of the two engines of a screw or paddle vessel, be able of itself to turn the centre?

A.—It will sometimes happen, when there is much lead upon the slide valve, that the single engine, on being started, cannot be got to turn the centre if there be a strong opposing wind and sea; the piston going up to near the end of the stroke, and then coming down again without the crank being able to turn the centre. In such cases, it will be necessary to turn the vessel's head sufficiently from the wind to enable some sail to be set; and if once there is weigh got upon the vessel the engine will begin to work properly, and will continue to do so though the vessel be put head to wind as before.

741. Q.—What should be done if a crack shows itself in any of the shafts or cranks?

A.—If the shafts or cranks crack, the engine may nevertheless be worked with moderate pressure to bring the vessel into port; but if the crack be very bad, it will be expedient to fit strong blocks of wood under the ends of the side levers, or other suitable part, to prevent the cylinder bottom or cover from being knocked out, should the damaged part give way. The same remark is applicable when flaws are

discovered in any of the main parts of the engine, whether they be malleable or cast iron; but they must be carefully watched, so that the engines may be stopped if the crack is extending further. Should fracture occur, the first thing obviously to be done is to throw the engines out of gear; and should there be much weight on the vessel, the steam should at once be thrown on the reverse side of the piston, so as to counteract the pressure of the paddle wheel.

742. Q.—Have you any information to offer relative to the lubrication of engine bearings?

A.—A very useful species of oil cup is now employed in a number of steam vessels, and which, it is said, accomplishes a considerable saving of oil, at the same time that it more effectually lubricates the bearings. A ratchet wheel is fixed upon a little shaft which passes through the side of the oil cup, and is put into slow revolution by a pendulum attached to its outside, and in revolving it lifts up little buckets of oil and empties them down a funnel upon the centre of the bearing. Instead of buckets a few short pieces of wire are sometimes hung on the internal revolving wheel, the drops of oil which adhere on rising from the liquid being deposited upon a high part set upon the funnel, and which, in their revolution, the hanging wires touch. By this plan, however, the oil is not well supplied at slow speeds, as the drops fall before the wires are in the proper position for feeding the journal. Another lubricator consists of a cock or plug inserted in the neck of the oil cup, and set in revolution by a pendulum and ratchet wheel, or any other means. There is a small

cavity in one side of the plug which is filled with oil when that side is uppermost, and delivers the oil through the bottom pipe when it comes opposite to it.

743. Q.—What are the prevailing causes of the heating of bearings?

A.—Bad fitting, deficient surface, and too tight screwing down. Sometimes the oil hole will choke, or the syphon wick for conducting the oil from the oil cup into the central pipe leading to the bearing will become clogged with mucilage from the oil. In some cases bearings heat from the existence of a cruciform groove on the top brass for the distribution of the oil, the effect of which is to leave the top of the bearings dry. In the case of revolving journals the plan for cutting a cruciform channel for the distribution of the oil does not do much damage; but in other cases, as in beam journals, for instance, it is most injurious, and the brasses cannot wear well wherever the plan is pursued. The right way is to make a horizontal groove along the brass where it meets the upper surface of the bearing, so that the oil may be all deposited on the highest point of the journal, leaving the force of gravity to send it downwards. This channel should, of course, stop short a small distance from each flange of the brass, otherwise the oil would run out at the ends.

744. Q.—If a bearing heats, what is to be done?

A.—The first thing is to relax the screws, slow or stop the engine, and cool the bearing with water, and if it is very hot, then hot water may be first employed to cool it, and then cold. Oil with sulphur intermingled is then to be administered, and as the parts

cool down, the screws may be again cautiously tightened, so as to take any jump off the engine from the bearing being too slack. The bearings of direct acting screw engines require constant watching, as, if there be any disposition to heat manifested by them, they will probably heat with great rapidity from the high velocity at which the engines work. Every bearing of a direct acting screw engine should have a cock of water laid on to it, which may be immediately opened wide should heating occur; and it is advisable to work the engine constantly, partly with water, and partly with oil applied to the bearings. The water and oil are mixed by the friction into a species of soap, which both cools and lubricates, and less oil moreover is used than if water were not employed. It is proper to turn off the water some time before the engine is stopped, so as to prevent the rusting of the bearings.

MANAGEMENT OF LOCOMOTIVES.

745. Q. — What are the chief duties of the engine driver of a locomotive?

A. — His first duties are those which concern the safety of the train; his next those which concern the safety and right management of the engine and boiler. The engine driver's first solicitude should be relative to the observation and right interpretation of the signals; and it is only after these demands upon his attention have been satisfied, that he can look to the state of his engine.

746. Q. — As regards the engine and boiler, what should his main duties be?

A. — The engineer of a locomotive should constantly be upon the foot board of the engine, so that the regulator, the whistle, or the reversing handle may be used instantly, if necessary; he must see that the level of the water in the boiler is duly maintained, and that the steam is kept at a uniform pressure. In feeding the boilers with water, and the furnaces with fuel, a good deal of care and some tact is necessary, as irregularity in the production of steam will often occasion priming, even though the water be maintained at a uniform level; and an excess of water will of itself occasion priming, while a deficiency is a source of obvious danger. The engine is generally furnished with three gauge cocks, and water should always come out of the second gauge cock, and steam out of the top one when the engine is running: but when the engine is at rest, the water in the boiler is lower than when in motion, so that when the engine is at rest, the water will be high enough if it just reaches to the middle gauge cock. In all boilers which generate steam rapidly, the volume of the water is increased by the mingled steam, and in feeding with cold water the level at first falls; but it rises on opening the safety valve, which causes the steam in the water to swell to a larger volume. In locomotive boilers, the rise of the water level due to the rapid generation of steam is termed "false water." To economise fuel, the variable expansion gear, if the engine has one, should be adjusted to the load, and the blast pipe should be

worked with the least possible contraction; and at stations the damper should be closed to prevent the dissipation of heat.

747. *Q.*—In starting from a station, what precautions should be observed with respect to the feed?

A.—In starting from a station, and also in ascending inclined planes, the feed water is generally shut off; and therefore before stopping or ascending inclined planes, the boiler should be well filled up with water. In descending inclined planes an extra supply of water may be introduced into the boiler, and the fire may be fed, as there is at such times a superfluity of steam. In descending inclined planes the regulator must be partially closed, and it should be entirely closed if the plane be very steep. The same precaution should be observed in the case of curves, or rough places on the line, and in passing over points or crossings.

748. *Q.*—In approaching a station how should the supply of water and fuel be regulated?

A.—The boiler should be well filled with water on approaching a station, as there is then steam to spare, and additional water cannot be conveniently supplied when the engine is stationary. The furnace should be fed with small quantities of fuel at a time, and the feed should be turned off just before a fresh supply of fuel is introduced. The regulator may, at the same time, be partially closed; and if the blast pipe be a variable one, it will be expedient to open it widely while the fuel is being introduced, to check the rush of air in through the furnace door, and then to contract it very much so soon as the furnace door is

closed, in order to recover the fire quickly. The proper thickness of coke upon the grate depends upon the intensity of the draught; but in heavily loaded engines it is usually kept up to the bottom of the fire door. Care, however, must be taken that the coke does not reach up to the bottom row of tubes so as to choke them up. The fuel is usually disposed on the grate like a vault; and if the fire box be a square one, it is heaped high in the corners, the better to maintain the combustion.

749. *Q.* — How can you tell whether the feed pumps are operating properly?

A. — To ascertain whether the pumps are acting well, the pet cock must be turned, and if any of the valves stick they will sometimes be induced to act again by working with the pet cock open, or alternately open and shut. Should the defect arise from a leakage of steam into the pump, which prevents the pump from drawing, the pet cock remedies the evil by permitting the steam to escape.

750. *Q.* — What precautions should be taken against priming in locomotives?

A. — Should priming occur from the water in the boiler being dirty, a portion of it may be blown out; and should there be much boiling down through the glass gauge tube the stop cock may be partially closed. The water should be wholly blown out of locomotive boilers three times a-week, and at those times two mud-hole doors at opposite corners of the boiler should be opened, and the boiler be washed internally by means of a hose. If the boiler be habitually fed with

dirty water, the priming will be a constant source of trouble.

751. Q. — What measures should the locomotive engineer take, to check the velocity of the train, on approaching a station where he has to stop?

A. — On approaching a station the regulator should be gradually closed, and it should be completely shut about half a mile from the station if the train be a very heavy one: the train may then be brought to rest by means of the breaks. Too much reliance, however, must not be put upon the breaks, as they sometimes give way, and in frosty weather are nearly inoperative. In cases of urgency the steam may be thrown upon the reverse side of the piston, but it is desirable to obviate this necessity as far as possible. At terminal stations the steam should be shut off earlier than at roadside stations, as a collision will take place at terminal stations if the train overshoots the place where it ought to stop. There should always be a good supply of water when the engine stops, but the fire may be suffered gradually to burn low towards the conclusion of the journey.

752. Q. — What is the duty of an engine man on arriving at the end of his journey?

A. — So soon as the engine stops it should be wiped down, and be then carefully examined: the brasses should be tried, to see whether they are slack or have been heating; and, by the application of a gauge, it should be ascertained occasionally whether the wheels are square on their axles, and whether the axles have end play, which should be prevented. The stuffing boxes must be tightened, and the valve gear

examined, and the eccentrics be occasionally looked at to see that they have not shifted on their axles, though this defect will be generally intimated by the irregular beating of the engines. The tubes should also be examined and cleaned out, and the ashes emptied out of the smoke box through the small ash door at the end. If the engine be a six-wheeled one, with the driving wheels in the middle, it will be liable to pitch and oscillate if too much weight be thrown upon the driving wheels; and where such faults are found to exist, the weight upon the driving wheels should be diminished. The practice of blowing off the boiler by the steam, as is always done in marine boilers, should not be permitted as a general rule in locomotive boilers, when the tubes are of brass and the fire box of copper; but when the tubes and fire boxes are of iron, there will not be an equal risk of injury. Before starting on a journey, the engine man should take a summary glance beneath the engine — but before doing so he ought to assure himself that no other engine is coming up at the time. The regulator, when the engine is standing, should be closed and locked, and the eccentric rod be fixed out of gear, and the tender break screwed down; the cocks of the oil vessels should at the same time be shut, but should all be opened a short time before the train starts.

753. Q. — What should be done if a tube bursts in the boiler?

A. — When a tube bursts, a wooden or iron plug must be driven into each end of it, and if the water or steam be rushing out so fiercely that the exact

position of the imperfection cannot be discovered, it will be advisable to diminish the pressure by increasing the supply of feed water. Should the leak be so great that the level of the water in the boiler cannot be maintained, it will be expedient to drop the bars and quench the fire, so as to preserve the tubes and fire box from injury.

754. Q.— If any of the working parts of a locomotive break or become deranged, what should be done ?

A.— Should the piston rod or connecting rod break, or the cutters fall out or be clipped off — as sometimes happens to the piston cutter when the engine is suddenly reversed upon a heavy train — the parts should be disconnected, if the connection cannot be restored, so as to enable one engine to work ; and of course the valve of the faulty engine must be kept closed. If one engine has not power enough to enable the train to proceed with the blast pipe full open, the engine may perhaps be able to take on a part of the carriages, or it may run on by itself to fetch assistance. The same course must be pursued if any of the valve gearing becomes deranged, and the defects cannot be rectified upon the spot.

755. Q.— What are the most usual causes of railway collisions ?

A.— Probably fogs and inexactness in the time kept by the trains. Collisions have sometimes occurred from carriages having been blown from a siding on to the rails by a high wind ; and the slippery state of the rails, or the fracture of a break, has sometimes occasioned collisions at terminal stations. Collision has also repeatedly taken place from one engine having

overtaken another, from the failure of a tube in the first engine, or from some other slight disarrangement; and collision has also taken place from the switches having been accidentally so left as to direct the train into a siding, instead of continuing it on the main line. Every train now carries fog signals, which are detonating packets, which are fixed upon the rails in advance or in the rear of a train which, whether from getting off the rails or otherwise, is stopped upon the line, and which are exploded by the wheels of any approaching train.

756. Q.—What other duties of an engine-driver are there deserving attention?

A.—They are too various to be all enumerated here, and they also vary somewhat with the nature of the service. One rule, however, of universal application, is for the driver to look after matters himself, and not delegate to the stoker the duties which the person in charge of the engine should properly perform. Before leaving a station, the engine-driver should assure himself that he has the requisite supply of coke and water. Besides the firing tools and rakes for clearing the tubes, he should have with him in the tender a set of signal lamps and torches, for tunnels and for night, detonating signals, screw keys, a small tank of oil, a small cask of tallow, and a small box of waste, a coal hammer, a chipping hammer, some wooden and iron plugs for the tubes, and an iron tube holder for inserting them, one or two buckets, a screw jack, wooden and iron wedges, split wire for pins, spare cutters, some chisels and files, a pinch bar, oil cans and an oil syringe, a chain, some spare bolts, and some cord, spun yarn, and rope.

INDEX TO 'INTRODUCTION.'

- "Achilles," engines of the, 114.
Actual and nominal horse power explained, 38; ratio of, 38.
"Adventure," power and performance of, 40.
"Africa," boilers of, 41.
Air pump of Humphry's screw engines, 126.
"Albion," power and performance of, 40.
American locomotives, 152.
"Amphion," engines of the, designed by Holm, 115.
Annealed wheels for American locomotives, 157.
Annular engines by Simpson, designed by D. Thomson, 129.
Appold's centrifugal pump, 78.
"Arctusa," power and performance of, 40.
"Asia," boilers of, 41.
Aveling & Porter's traction engine, 196.
Axle boxes of American locomotives, 156.
Balanced double cylinder engine, 59.
"Barossa," power and performance of, 40.
Beam engine and sugar mill, 83.
Beardmore's super-heater, 43.
Bearings of feathering paddle-wheels in sandy rivers should be steeled, 37.
Bearings of shafts, 36.
Beattie's coal-burning locomotive, 135.
"Black Prince," power and performance of, 40; engines of the, 114.
Blowing-off ineffectual in preventing incrustation of sulphate of lime in marine boilers using high pressure steam, 18; proper alternative, 19.
Bogie, use of in American locomotives, 152, 158.
Boilers, marine, should not be fed with distilled water exclusively, 17; corroded internally by galvanic action of surface condensers, 17; proposed remedy for, 18; incrustations of sulphate of lime in, from heat alone without concentration, 18; remedy for, 19.
Boilers, proportions of, 48; by Smeaton, 49; by Watt, 49; Cornish, 49; tubular marine in 1844, 50; in 1865, 51; of steamers "Sultan," "Poonah," "Delhi," "Carnatic," "Baroda," "Moulton," "Ripon," and "Syrta," 52.
Boilers of steamers "Asia" and "Africa," 41; of Collins' line of steamers, 47.
Boilers, portable, with removable furnace and tubes, 216.
Boilers with upright tubes, 48.
Boulton & Watt, superheater of "Great Eastern" by, 12; pumping engines by, 58; modern marine engines by, 111.
Bourne, John, investigated effect of superheating in 1834, 5; published estimate of the benefit in 1844, 5; pointed out cause of internal corrosion of boilers in 1844, 5; predicted internal corrosion of superheaters, 5; suggests remedy for internal corrosion of superheaters, 6; recommended present practice of carrying chimney clear of steam chest, 6; first introduced expansion slide valve with moveable plates, 14; first constructed tubular marine boiler, 14; patented surface condensers for steam vessels with a high pressure of steam in 1838, 14; invented condenser for feeding boiler with boiling water, 19, 20; first proposed combination of paddles and screw, 24;

- predicted abandonment of geared engines for driving screw, 25; urged the adoption of the form of direct acting engine now become general, 26; first introduced the method of balancing the momentum of screw engines, 26; first introduced marine engine governors, 27; first introduced balancing valves by stationary ring, 30; contrived a form of link motion in 1836, 31; first introduced starting cylinders and starting valves, 33; first promulgated the existing rules for the computation of the nominal power of engines, 39; first promulgated the doctrine that smoke should not be burned but prevented, 53; forms of smokeless furnace by, 53; pointed out the correct principle on which ships should be modelled, 54; first promulgated the doctrine that the resistance of well-formed ships is chiefly produced by friction, 54; pointed out the advantages of twin screws in 1852, 57; reheated the steam in double cylinder engines in 1859, 86; first accomplished riveting by steam, 90.
- Boydell's traction engine, 193.
 Bray's traction engine, 195.
 "Brilliant," screw yacht, engines of, by Day & Co., 122.
 Broad gauge locomotives, 161.
 Butt & Co.'s steam fire engine, 228.
- Caird & Co., engines by, 126.
 "Carnatic," power and performance of, 52.
- Carrett, Marshall & Co.'s double cylinder engine, 59; engine and boiler combined, 61; vertical engine and boiler, 63; pumping engine and boiler, 64, 65; inverted engines, 66; other engines, 67, 70 to 77; steam hammer, 95.
- Centrifugal pump, Appold's, 78.
- Chaplin's vertical engine, 86; steam winches and cranes, 88.
- Chimney should not be carried through steam chest, 6.
- Chimney, sectional area of, per nominal horse power, 50; in different vessels, 52.
- Circulation of water in surface condensers, 21.
- Clayton, Shuttleworth & Co.'s traction engine, 207; steam pump, 210.
- Coal more economical than zinc, 5.
- Coal burning locomotives, 135.
- "Collingwood," power and performance of, 40.
- Combination of paddles and screw proposed by Bourne in 1850, 24.
- Condensation of steam incident to the production of power, 7.
- Condenser, surface, by Bourne, in 1838, 14.
- Condenser for feeding boilers with boiling water, by Bourne, 20.
- Condensing surface per nominal horse power in different vessels, 52.
- Condie's steam hammer, 93.
- "Conqueror," power and performance of, 40.
- "Constance," power and performance of, 40.
- Continuous expansion engine, by Nicholson, 85.
- Cornish boilers, 49.
- Corrosion, internal, of boilers, cause of pointed out by Bourne, 5.
- Corrosion, internal, of superheaters predicted by Bourne, 5; suggested remedy for internal corrosion, 6; of boilers, 18; best mode of preventing, 19.
- Cowcatcher of American locomotives, 153.
- Cowper's combined engines, 81 to 85.
- Cranes and winches worked by steam, 88.
- Cudworth's coal-burning locomotive, 135.
- Day & Co., modern marine engines by, 122; shears worked by steam by, 81.
- "Defence," power and performance of, 40.
- "Diance," power and performance of, 40.
- Delabarre's steam jet, 106.
- "Delini," power and performance of, 52.
- Details of modern locomotives, 177.
- Dewrance's coal-burning locomotive, 135.
- Diagrams, indicator, from screw yacht "Brilliant," 124; of Shand, Mason & Co.'s fire engine, 223.
- Donkey engine by Hawthorn, 71; by Carrett, Marshall & Co., 72, 73.
- Double cylinder engines, proper limits of, 22; compared with single, 53.
- Double screws, 57.
- "Duncan," power and performance of, 40.
- Dundonald, Earl of, boilers by, 48.
- Easton, Amos & Son, centrifugal pump by, 78 to 81; steam fire engine by, 228.
- Eastern of France Railway, locomotives of the, 163.
- Eccentrics of locomotives, 186.

- Economy of high temperatures, 4.
 Economy of fuel in steamers very important, 15.
 Electro-Magnetic engines less economical than heat engines, 4.
 "Emerald," power and performance of, 40.
 Engerth' locomotives, four and five coupled axles, 152.
 England & Co., mineral locomotive by, 189.
 Equivalent, mechanical, of heat, 3.
 "Euryalus," power and performance of, 40.
 Expansion of steam, 13.
 Expansion slide valves with moveable plates, first introduced by Bourne, 14; reproduced by Mayer and others, 14.
 Express passenger locomotives, 161, 163, 174.
 Feeding boilers by Giffard's injector, 102.
 Ferrabee, engine by, 67, 69.
 Fire engines worked by steam, 217 to 228.
 Fletcher, Jennings & Co., mineral locomotives by, 189.
 Flues, boiler, sectional area of, per nominal horse power, 50; in different vessels, 52.
 Foreign goods locomotives, 143, 152.
 Four-cylinder locomotives, 147, 152.
 Frictional gearing, 78.
 Friction of water on bottoms of ships, the main element of their resistance, 55; friction more at bow than at stern, 56; means of reducing friction and recovering power expended upon it, 56.
 Fuel, economy of fuel in steamers very important, 15.
 "Galatea," power and performance of, 40.
 Galvanic battery an expensive source of power, 5.
 Galvanic action of surface condensers on boilers, 17; proposed remedy for, 18.
 Garrett & Son's traction engine, 207; steam plough, 211.
 Gearing, frictional, 78.
 "Gibraltar," power and performance of, 40.
 Giffard's injector, 102.
 "Glasgow," power and performance of, 40.
 Glasgow and South Western Railway, goods engines of, 172.
 Goods locomotives of foreign railways, 143; with four cylinders, 147, 152; American, 152.
 Grate surface, per nominal horse power, 50; in different vessels, 52.
 Gray's coal-burning locomotive, 135.
 Gray & Son's steam fire engine, 228.
 "Great Britain" locomotive, 161.
 "Great Eastern," superheater of, 12.
 Great Northern Railway, coupled express passenger engines of the, 176.
 Great Western Railway, express passenger engines on, 161.
 Guides of locomotives, 184.
 Hawthorn, R. & W., modern marine engines by, 130; donkey engines by, 71; locomotives by, for the Glasgow and South Western; London, Dove, and Chatham; Great Northern and Coplapo extension railways, 172 to 175.
 Heat, mechanical equivalent of, 3.
 Heating surface, per nominal horse power, 50; in different boilers, 49 to 51; in different vessels, 52.
 High temperatures, economy of, 4.
 High pressure of steam, advantages of, 13.
 Holm, Engines of the "Amphion" and "Pomone," designed by him, 115.
 Horse power, nominal and actual explained, 38; varying ratios of, 38.
 Horse power, nominal, rule for finding first given by Bourne, 39; origin of Admiralty rule, 39; new rule for screw engines, 39.
 Humphrys first introduced ring at back of valve to take off pressure, 30.
 Humphrys & Tennant, modern marine engines by, 125.
 "Hydra," steam boilers of, by Penn, 43.
 Ice locomotive, 191.
 Ice made by steam, 237.
 Incrustation of sulphate of lime in boilers, using salt water with high pressure steam, 18; mode of preventing, 19.
 Indicator diagrams from screw yacht "Brilliant," 124; of Sband, Mason & Co.'s fire engine, 223.
 Internal corrosion of boilers from galvanic action of surface condensers, 17; proposed remedy for, 18, 19.
 "Iron Duke" locomotive, 161.
 Jackets of cylinders, benefits of, 107.
 Jet, supplementary, of water in surface, condensers, 17; advantage of, 21.
 Jet, steam, by Delabarre, 106.

- Joule, his researches respecting the mutual relations of heat and power, 3.
- Kirk's machine for making ice by steam, 237.
- "Lacy" locomotive, 135.
- Lamb & Summers' superheater, 8; boiler, 45.
- "Leander," power and performance of, 40.
- "Liffey," power and performance of, 40.
- Lignum vitae bearings, 37.
- Link motion, form of contrived by Bourne in 1836, 31; present form subsequently introduced by Stephenson, 31; link motion of locomotives, 185.
- "Liverpool," power and performance of, 40.
- Locomotive engines, 133; coal-burning, 135; express passenger of English lines, 161, 163, 174; modern details of, 177; mineral, 188; for goods on foreign railways, 143; with 4 cylinders, 147, 152; American, 152.
- Locomotive for running on ice, 191.
- Locomotives for common roads, 192 to 207.
- Locomotive axle boxes in America, 156.
- Locomotive wheels of cast iron, 156.
- London, Chatham, and Dover Railway, engines of, 172.
- London and North Western Railway, express passenger engines on, 163.
- Loss of power in steam engines, 3.
- Lyons Railway, engines of the, 163.
- McConnell's coal-burning locomotive, 135.
- Manning, Wardle & Co., mineral locomotive by, 169.
- Marine boilers, tubular, first made in 1838 by Bourne, 13; present forms of, 43; proportions of, 60.
- Marine boilers by Lamb & Summers, 45.
- Marine governors, first introduced by Bourne, 27; Silver's, 29; Porter's, 29.
- Maudslay & Field, modern marine engines by, 117.
- Mayer, expansion valve by, 14.
- "Meance," power and performance of, 40.
- Mechanical equivalent of heat, 3.
- Merryweather & Son's steam fire engine 224.
- Millwall Iron Co., modern marine engines by, 129.
- Mineral locomotives, 188.
- Modern forms of screw engines, 25.
- Modern forms of boilers, 41.
- Modern locomotives, details of, 177.
- Momentum of screw engines first balanced by Bourne, 26; principle on which balance is effected, 27.
- "Moulton," power and performance of, 52; engines of the, 135.
- "Munster" and "Ulster" steamers, details of, 111.
- Napier & Sons, superheater of "Oleg" by, 8; boilers by, 41; modern marine engines by, 119, 121.
- Napier, David, boilers by, 48.
- Nasmyth's steam hammer, 91.
- Neath Abbey Co., mineral locomotive by, 169.
- New River Waterworks, engines at, 38.
- Nichol's steam fire engine, 226.
- Nicholson's continuous expansion engine, 88.
- Nominal and actual horse power, 38.
- Northern Railway of France, locomotives on the, 143, 152.
- "Octavia," power and performance of, 40.
- "Oleg" steamer, superheater of, 8.
- Orleans Railway, engines of the, 146, 152.
- "Orontes," power and performance of, 40.
- Paddles and screw, combination of first proposed by Bourne, 24.
- Paris and Orleans Railway, locomotives on the, 140, 152.
- Penn first took pressure off valves by equilibrium frame, 30; introduced wooden bearings for shafts, 37.
- Penn & Son, modern marine engines by, 113.
- Piston of engines carbonised by tallow, if high temperature maintained, 17.
- Pistons and piston rods of locomotives, 181.
- Ploughing by steam, 211.
- "Pomone," engines of the, designed by Holm, 115.
- "Poonah," power and performance of, 52.
- Portable engine by Ransomes & Sims, 215.
- Porter's marine governor, 29.
- Power of engines only one-tenth of theoretical effect, 3.
- Power, equivalent of, as heat, 3.
- Power, nominal and actual horse, 38.
- "Prince Consort," power and performance of, 40.
- "Princess Royal," power and performance of, 40.

- Proportions of boilers, 48.
Pumping engines at New River, 58.
- Ramsbottom's locomotive, 165; mode of supplying water to tenders while running, 165.
- Ransomes & Sims' portable engines, 215; boiler with removable furnace and tubes, 216.
- Ravenhill, Salkeld & Co., modern marine engines by, 115.
- "Resistance," power and performance of, 40.
- Resistance of ships, present doctrines first promulgated by Bourne, 54.
- "Revenge," power and performance of, 40.
- "Rhone" steamer, engines of, 129.
- Rigby's steam hammer, 100.
- "Ripon," steamer, boilers of, by Lamb & Summers, 46.
- "Ripon," power and performance of, 52.
- Riveting by steam first introduced by Bourne, 90; Fairbairn's machine, 91; Garforth's, 91.
- Roads, common, locomotives for, 192 to 207.
- Roberts' steam fire engine, 238.
- Robey & Co's, traction engine, 204.
- "Rolfe Krake," armour plated steamer, by R. Napier & Sons, 120.
- Rowan's expansive engine, 127.
- "Royal Oak," power and performance of, 40.
- Savory's system of steam culture, 211.
- Scale of sulphate of lime formed in marine boilers by heat without concentration, 18; proper preventative, 19.
- "Scotia," engines of the, 119.
- Scott's cement for coating corroded iron, 19.
- Screw and paddles, combination of, first proposed by Bourne, 24.
- Screw engines, modern forms of, 25; momentum of, first balanced by Bourne, 26; principle on which balance is effected, 27; horizontal direct acting engines recommended by Bourne in 1852 have since become general, 26; new rule for nominal power of, 29.
- screw propellers recover part of the power expended in moving vessels, 56; double screws, 57; various forms of screws, 57.
- Shafts and shaft bearings, 35.
- Shand, Mason & Co's. steam fire engine, 218.
- "Shannon," power and performance of, 40.
- Sharp, Stewart & Co's. coal-burning locomotive, 139.
- "Shearwater," engines of the, by Hawthorn, 180.
- Shears for lifting heavy weights, by Day & Co., 88.
- Ships, proper form of, 55; resistance of, mainly due to friction, as first pointed out by Bourne, 55.
- Single and double cylinder engines compared, 58.
- Silver's marine governor, 29.
- Smeaton's boilers, 49.
- Smoke-burning, 53.
- Smoke, prevention of, by Bourne, 53.
- Scrammering incline, locomotives for the, 149.
- Spark-catcher of American locomotives, 152.
- Starting cylinders first introduced by Bourne, 33; of "Ulster" and "Munster," 33.
- Starting valves introduced by Bourne in 1852, 35.
- Steam applied to work winches, cranes, and shears, 88.
- Steam chest, benefit of carrying the chimney clear of it first pointed out by Bourne, 6.
- Steam is necessarily condensed in the production of power unless superheated, 7.
- Steam culture, 211.
- Steam fire engine, 217; by Shand, Mason & Co., 218; by Merryweather & Son, 224; by Easton, Amos & Son, 228; by Butt & Co., 228; by Roberts, 228; by Nichols, 228; by Gray & Son, 228.
- Steam hammers, 91; Nasmyth's 91; Wilson's, 91; Condie's, 93; Carrett, Marshall & Co's, 95; Thwaites & Carbott's, 97; Rigby's, 100.
- Steam jackets, benefits of, 107.
- Steam jet, Delabarre's, 106.
- Steam power, ice made by, 237.
- Steam riveting first introduced by Bourne, 90; Fairbairn's machine, 91; Garforth's, 91.
- Steel shafts, 26.
- Sugar mill, 82.
- Sulphate of lime deposited in marine boilers by heat without concentration, 18; mode of preventing, 19.
- "Sultan," power and performance of, 52.
- Superheaters, internal corrosion of, predicted by Bourne at their first

- Introduction, 5; proper surface for, 13.
- Superheater of "Oleg," by Napier & Sons, 8; form of by Lamb & Summers, 8; of Great Eastern, 12.
- Superheater by Beardmore, 43.
- Superheating the steam, 5; benefits of superheating pointed out by Bourne in 1844, 5; subsequent exaggerated estimates of advantage, 6.
- Surface condensers, by Watt, 14; by Hall, 14; by Bourne in 1838, 14; proper proportions of, 16; importance of rapid circulation of water in, 16; waste the boilers by galvanic action, 17.
- Surface of super-heaters, 13.
- "Sutherland," steam fire engine, 229.
- "Sutlej," power and performance of, 40.
- "Syria," power and performance of, 52.
- Tallow, inconvenience of, in surface condensers from distilling over, 17; inconveniences of in hot cylinders from carbonizing the piston, 17.
- Tembrinck's coal-burning locomotive, 135, 142.
- Temperatures, high, economy of, 4.
- Tenders, locomotive, mode of filling while running, 165.
- Thermo-dynamics, 2.
- Thomson, David, pumping engines designed by, 59; double acting plunger pump invented by him, 219; Simpson's annular engines designed by, 129.
- Thwaites & Carbutt's steam hammer, 97.
- "Torrent" steam fire engine, 233.
- Traction engines, Bourne's (Artizan), 192; Boydell's, 193; Bray's, 196; Aveling & Porter's, 196; Robey & Co.'s, 204; Garrett & Son's, 207; Clayton, Shuttleworth & Co.'s, 207.
- Tabular marine boilers first constructed in 1838 by Bourne, 13; present forms of, 43; proportions of in 1844, 50; in 1865, 51.
- Turin railway, locomotives of the, 153.
- Twin screws, 57.
- "Ulster" and "Munster," details of, 111.
- "Undaunted," power and performance of, 40.
- Various forms of screw, 57
- "Warrior," power and performance of 40; engines of the, 114.
- Water, bodies of good shape moving in water resisted chiefly by friction, 55.
- Water works, engines for, 58.
- Water, mode of supplying to tenders while running, 165.
- Watt's boilers, 49.
- Western of France Railway, 153.
- Wilson's steam hammer, 91.
- Winches and cranes worked by steam, 88.
- Wooden bearings, 37.
- Yarrow's coal-burning locomotive, 135.
- Zinc a more expensive source of power than coal, 5.

INDEX.

- ACCIDENTS in steam vessels, proper preparation for, 534.
Admiralty rule for horse power, 138.
Adhesion of wheels of locomotives to rails, 331.
Agricultural fixed engines, 476; prices of, 492.
Agricultural engines, portable, 455; prices of, 475.
Air, velocity of, entering a vacuum, 7; required for combustion of coal, 91; law of expansion of, by heat, 108.
Air pump, description of, 58; action of, 60. 67; proper dimensions of, 207.
Air pump of marine engines, details of, 299.
Air pump of oscillating engine, 414.
Air pump of direct acting screw engines, 435. 440.
Air pumps made both single and double acting, 208; difference of, explained, 208.
Air pumps, double acting valves of, 303; bad vacuum in, 306; causes and remedy, 307—309.
Air pump rods, brass or copper, in marine engines, 299.
Air pump bucket, valves of, 300, 301, 302.
Air pump, connecting rod and cross head of oscillating engine, 420.
Air pump rod of oscillating engine, 420.
Air pump arm, 439
Air vessels applied to suction side of pumps, 215.
"Alma," engine of, by Messrs. John Bourne and Co., 433.
"Amphion," engines of, 285.
Angle iron in boilers, precautions respecting, 234.
Apparatus for raising screw propeller, 320.
Atmospheric valve, 48.
Atmospheric resistance to railway trains, 332—336.
Auxiliary power, screw vessels with, 405.
Axle bearings of locomotives, 346.
Axle guards, 449.
Axles and wheels of modern locomotives, 450.
"Azof," slide valve of, 296.
Babbitt's metal, how to compound, 517.
Bach and Co.'s portable engine, 468.
Balance piston to take pressure off slide valve, 437.
Ball valves, 352.
Barrel of boiler of modern locomotives, 447.
Barrett, Exall, and Andrewes' portable engine, 473; fixed engine, 481.
Batley's portable engine, 474.
Beam, working of land engine, 54; main or working strength proper for, 220.
Beam engine by Tuxford, 482.
Bearings of engines or other machinery, rule for determining proper surface of, 31.
Bearings, heating of, how to prevent or remedy, 538; journals should always bottom, as if they grip on the sides the pressure is infinite.
Beattie's screw, 398.
Bellidors valves might be used for foot and delivery valves, 300.
Bell-metal, composition of, 519.
Benson's vertical engine, 488.
Blast pipe of locomotives, description of, 8.

- Blast** in locomotives, exhaustion produced by, 174; proper construction of the blast pipe, 175; the blast pipe should be set below the root of the chimney so much that the cone of escaping steam shall just fill the chimney.
- Blast pipe** with variable orifice, at one time much used, 177.
- Blow off cock** of locomotives, 266.
- Blow off cocks** of marine boilers, proper construction of, 312.
- Blow off cocks**, description of, 69.
- Blowing off** supersalted water from marine boilers, 7.
- Blowing off**, estimate of heat lost by, 250; mode of, 252, 529.
- Blow through valve**, description of, 70.
- Blowing furnaces**, power necessary for, 504.
- Bodies**, falling, laws of, 9.
- Bodmer**, expansion valve by, 129.
- Boilers**, general description of: the wagon boiler, 45; the Cornish boiler, 50; the marine flue boiler, 51; the marine tubular boiler, 53; locomotive boiler—see Locomotives.
- Boilers**, proportions of: heating surface of, 158—160; fire grate, surface of, 160; consumption of fuel on each square foot of fire bars in wagon, Cornish, and locomotive boilers, 160; calorimeter and vent of boilers, 161; comparison of proportions of wagon, flue, and tubular boilers, 162—169; evaporative power of boilers, 169; power generated by evaporation of a cubic foot of water, 170; proper proportions of modern marine boilers, both flue and tubular, 172; modern locomotive boilers, 173; exhaustion produced by blast in locomotives, 174; increased evaporation from increased exhaustion, 176; strength of boilers, 189; experiments on, by Franklin Institute, 190; by Mr. Fairbairn, 191; mode of computing strength of boilers, 191, 192; staving of, 193—195.
- Boilers**, marine, prevented from salting by blowing off, 7; early locomotive and contemporaneous marine boilers compared, 178—180; chimneys of land, 174, 180; rules for proportions of chimneys, 181; chimneys of marine boilers, 182.
- Boilers**, constructive details of: riveting and caulking of land boilers, 232; proving of, 232; seams payed with mixture of whiting and linseed oil, 232; setting of wagon boilers, 233; riveting of marine boilers, 233; precautions respecting angle iron, 234; how to punch the rivet holes and shear edges of plates, 234; setting of marine boilers in wooden vessels, 235; mastic cement for setting marine boilers, 235; composition of mastic cement, 236; best length of furnace, 236; configuration of furnace bars, 237; advantages and construction of furnace bridges, 238; various forms of dampers, 239; precautions against injury to boilers from intense heat, 240; tubing of boilers, 241; proper mode of staying tube plates, 242; proper mode of constructing steam boat chimneys, 243; waste steam pipe and funnel casing, 244; telescope chimneys, 245; formation of scale in marine boilers, 246; injury of such incrustations, 247; amount of salt in sea water, 248; saltiness permissible in boilers, 248; amount of heat lost by blowing off, 250; mode of discharging the supersalted water, 252; Lamb's scale preventer, 253; internal corrosion of marine boilers, 254; causes of internal corrosion, 256; surcharged steam produced from salt water, 257; stop valves between boilers, 258; safety or escape valve on feed pipe, 260; locomotive boilers consist of the fire box, barrel for holding tubes, and smoke box, 261; dimensions of the barrel and thickness of plates, 262; mode of staying fire box and furnace crown, 262, 263; fire bars, ash box, and chimney, 264; steam dome used only in old engines, 265; manhole, mudholes, and blow off cock, 266; tube plate, and mode of securing tubes, 268; expanding mandrils, 268; various forms of regulator, 269, 270.
- Boilers** of modern locomotives, 447.
- Boiler**, the, proper care of, the first duty of the engineer, 534.
- Bolts**, proper proportions of, 329.
- Boring** of cylinders, 508.
- Boulton and Watt**, engines of "City of Canterbury" and "Red Rover," by, 67.
- Boulton and Watt's** rules for fly wheel, 12; proportions of marine flue boilers, 160; rule for proportions of chimneys of land boilers,

- 182; of marine boilers, 183; experiments on the resistance of vessels in water, 363-367.
- Bourdon's steam and vacuum gauges, 143.
- Bourne, expansion valves by, 129, 130.
- Bourne, Messrs. J. and Co., direct acting screw engines by, 433.
- Bras for bearings, composition of, 517.
- Bracing solders, 519.
- Bridges in furnaces, benefits of, 238.
- Burning of boilers, precautions against, 240.
- Burrall's portable agricultural engine, 472.
- Bursting velocity of fly wheel, 14; and of railway wheels, 15.
- Bursting of boilers, 195; causes of, 196; precautions against, 197; may be caused by accumulations of salt, 200.
- Butlin's portable engine, 474.
- Butterfly valves of air pump, 300.
- Cabrey, expansion valve by, 127.
- Calorimeter of boilers, definition of, 161.
- Cams, proper forms of, 126.
- Cast iron, strength of, 33-36; proportions of cast iron beams, 38; effects of different kinds of strains on beams, 39-41; strength to resist shocks not proportional to strength to resist strains, 43; to attain maximum strength should be combined with wrought iron, 44.
- Casting of cylinders, 505-507.
- Case-hardening, how to accomplish, 515.
- Cataract, explanation of nature and uses of, 155.
- Caulking of land boilers, 232.
- Cement, mastic, for setting marine boilers, 235.
- Central forces, 12.
- Centre of pressure of paddle wheels, 371.
- Centres of gravity, gyration, and oscillation, 15.
- Centres for fixing arms of paddle wheel, 322.
- Centres of an engine, how to lay off, 521.
- Centrifugal force, nature of, 12; rule for determining, 13; bursting velocity of fly wheel, 14; and of railway wheels, 15.
- Centrifugal pump will supersede common pump, 280.
- Centripetal force, nature of, 12.
- Chimney of locomotives, 264.
- Chimney of steam vessels, what to do if carried away, 533.
- Chimneys of land boilers, 174, 180; Boulton and Watt's rule for proportions of, 181; of marine boilers, 182.
- Chimneys, exhaustion produced by, 174, 181; high and wide chimneys in locomotives injurious, 175.
- Chimneys of steam boats, 243; telescope, 245.
- "City of Canterbury," engines of, 67.
- Clayton, Shuttleworth, and Co.'s portable engine, 459; fixed engine, 478.
- Coal, constituents of, 90; combustion of, air required for, 91; evaporative efficacy of, 92; of wood, turf, and coke, 93.
- Cocks, proper construction of 311-315.
- Cog wheels for screw engines, 75.
- Coke, evaporative efficacy of, 93.
- Cold water pump, description of, 58; rule for size of, 215.
- Combustion, nature of, 90.
- Combustion of coal, air required for, 91.
- Combustion, slow and rapid, comparative merits of, 95; rapid combustion necessary in steam vessels, and enables less heating surface in the boiler to suffice, 95.
- Conchoidal propeller, 446.
- Condensation of steam, water required for, 209.
- Condenser, description of, 58; action of, 59, 67; proper dimensions of, 207.
- Condenser of oscillating engine, 418.
- Condenser of direct acting screw engine, 434.
- Condensing engine, definition of, 1.
- Condensing water, how to provide when deficient, 273.
- Conical pendulum or governor, 20, 21.
- Connecting rod, description of, 54, 67; strength proper for, 218, 224.
- Connecting rod of direct acting screw engines, 438; of locomotives, 344.
- Consumption of fuel on each square foot of fire bars in waggon, Cornish, and locomotive boilers, 160.
- Copper, strength of, 34.
- Corrosion produced by surcharged steam, 257.
- Corrosion of marine boilers, 254; causes of, 256.

- Cost of locomotives, 331.
 Cotton spinning, power necessary for, 502.
 Counter for counting strokes of an engine, 151.
 Crank, description of, 54; unequal leverage of, corrected by fly wheel, 3; no power lost by, 23; action of, 63; strength proper for, 294—296.
 Crank of direct acting screw engines, 434, 440, 442.
 Crank pin, strength proper for, 227.
 Crank pin of direct acting screw engines, 441.
 Cranked axle of locomotives, 345.
 Cross head, description of, 67; strength proper for, 227.
 Cross head of direct acting screw engines, 439.
 Cross tail, description of, 69.
 Crosskill's portable engine, 462; oscillating, 487.
 Cylinder, description of, 54; strength proper for, 217.
 Cylinder of oscillating engine, 412, 415, 430; of direct acting screw engine, 434, 436.
 Cylinders should have a steam jacket, and be felted and planted, 283; should have escape valves, 290.
 Cylinders of locomotives should be large, 338; proper arrangement of, 342.
 Cylinders, how to cast, 505—507; how to bore, 508; how to grind, 509
 Cylinder jacket, advantages of, 116.
- Damper, 48, 49.
 Dampers, various forms of, 239.
 Deadwood, hole in, for screw, 318.
 Delivery valve, description of, 58.
 Delivery or discharge valves, proper dimensions of, 209.
 Delivery valves might be made on Belidor's plan, 300.
 Delivery valves in mouth of air pump, 301; of india rubber, 302—306.
 Direct acting screw engines should be balanced, 287.
 Direct acting screw engine by Messrs. John Bourne and Co., 433; cylinder, 434, 436; discs, 434, 440, 442; guides, 435; screw shaft brasses, 435; air pump, 435, 440; slide valve, 437; balance piston, 437; connecting rod, 438; piston rods, 438; cross head, 439; air pump arm, 439; feed pump, 440; crank pin, 441; screw shaft, 443; thrust plummer block, 443, 444; link motion, 445; screw propeller, 446.
 Discharge valves, 314.
 Disc valves of india rubber for air pumps, 303—306.
 Discs of direct acting screw engine instead of crank, 434, 440, 442.
 Dodds, expansion valve by, 129.
 Double acting engines, definition of, 2, 3.
 Double acting air pumps, 208; valves of, 303; faults of, 306—309.
 Double side rod engine by Tuxford, 485.
 Draw bolt, 450.
 Dredging earth out of rivers, power necessary for, 504.
 Driving wheels of locomotives, 354.
 Driving piles, power necessary for, 504.
 Dundonald, Earl of, screw by, 396.
 Duty of engines and boilers, 139; how the duty is ascertainable, 140.
 Duty of Clayton and Shuttleworth's engines from 1849 to 1853, 461.
 Dynamometer, description of, 152.
 Dynamometric power of screw vessels, 390.
- Eccentric, description of, 69; sometimes made loose for backing, 298.
 Eccentric and eccentric rod of oscillating engine, 423.
 Eccentric notch should be fitted with a brass bush, 299.
 Eccentric straps of locomotives, 347; rods of locomotives, 348.
 Eccentrics of locomotives, 347; how to re-adjust, 351.
 Economy of fuel in steam vessels, 409.
 Edwards, expansion valve by, 29.
 Elasticity, limits of, 35.
 Engine, high pressure, definition of, 1; low pressure, definition of, 1.
 Engines, classification of, 2; rotative, definition of, 2; rotatory, definition of, 2; single acting, definition of, 2; double acting, definition of, 2, 3; mode of erecting in a vessel, 325—328; how to refix if they have become loose, 329.
 Engineers of steam vessels should make proper preparation for accidents, 534.
 Equilibrium slide valve, 294—297; gridiron valve, 296.
 Erecting engines in a vessel, 323—328.
 Erection of engines in the workshop, 519.

- Escape valve on feed pipe, 260.
 Escape valves for letting water out of cylinders, 290.
 Evaporative efficacy of coal, 92; of wood, turf, and coke, 93.
 Evaporative power of boilers, 165. 169; power generated by evaporation of a cubic foot of water, 170; increase of evaporation due to increased exhaustion in locomotives, 176.
 Exhaustion produced by chimneys, 174. 181; by the blast in locomotives, 174; increased evaporation from increased exhaustion, 176.
 Expanding mandrils for tubing boilers, 268.
 Expansion of air by heat, 108.
 Expansion of surcharged steam by heat, 108.
 Expansion of steam, 111; pressure of steam inversely as the space occupied, 112; law of expansion, 114; rule for computing the increase of efficiency produced by working expansively, 115; necessity of efficient provisions against refrigeration in working expansively, 116; advantages of steam jacket, 116. Forms of apparatus for working expansively: lap on the slide valve, 120; wire drawing the steam, 122; Cornish expansion valve, 124; in rotative engines worked by a cam, 125; mode of varying the degree of expansion, 126; proper forms of cams, 126; the link motion, 128; expansion valves, by Cabrey, Fenton, Dodds, Farcot, Edwards, Lavagrian, Bodmer, Meyer, Hawthorn, Gonsenbach, and Bourne, 127—130.
 Expansion joint in valve casing, 289.
 Expansion valves, Cornish, 124; the link motion, 128; by Cabrey, Fenton, Dodds, Farcot, Edwards, Lavagrian, Bodmer, Meyer, Hawthorn, Gonsenbach, and Bourne, 127—130.
 Explosions of boilers, 195; causes of explosions, 196; precautions against, 197—200; dangers of accumulations of salt, 200.
 Face plates or planometers, 511.
 Falling bodies, laws of, 9.
 Farcot, expansion valve by, 129.
 Feathering paddle wheels, description of, 73; details of, 428.
 Feed pump, description of, 58; action of, 60; proper dimensions of, 109; rule for proportioning, 213.
 Feed pump plunger, 310; and valves, 310.
 Feed pumps of locomotives, details of, 392.
 Feed pumps of direct acting screw engines, 440.
 Fenton, expansion valve by, 129.
 Ferrabee's pillar engine, 490.
 Fire bars of locomotives, 264.
 Fire box of locomotives, mode of staying, 262.
 Fire box of modern locomotives, 447.
 Fire grate surface of boilers, 160.
 Fire grate in locomotives should be of small area, 142; coke proper to be burned per hour on each square foot of bars, 142.
 Firing furnaces, proper mode of, 94.
 Fixed agricultural or manufacturing engines, 476.
 Fixed agricultural engines, prices of, 492.
 Flaws in valves or cylinders, how to remedy, 512.
 Float for regulating water level in boilers, 48. 154.
 Floats of paddle, 323.
 Floats of paddle wheels, increased resistance of, if oblique, 376; floats should be large, 378.
 Fly wheel corrects unequal leverage of crank, 3; proper energy for, 11; Boulton and Watt's rule for, 12; bursting velocity of, 14; description of, 54; action of, in redressing irregularities of motion, 63.
 Foot valve, description of, 58; proper dimensions of, 209.
 Foot valves might be made on Bell-dor's plan, 300; of india rubber, 302—306.
 Frame at stern for holding screw propeller, 318. 320.
 Framing of locomotives, 357.
 Framing of oscillating engine, 419.
 Franklin Institute, experiments on steam by, 105.
 French Academy, experiments on steam by, 105.
 Friction, nature of, 28; does not vary as the rubbing surfaces, but as the retaining pressure, 27; does not increase with the velocity per unit of distance, but increases with the velocity per unit of time, 27; measures of friction, 28; effect of unguents, 28; kind of unguent should vary with the pressure, 29; Morin's experiments, 29; rule for determining

- proper surfaces of bearings, 31;
friction of rough surfaces, 32.
- Friction of the water the main cause of the resistance of vessels of good shape, 361.
- Fuel burnt on each square foot of fire bars in waggon, Cornish, and locomotive boilers, 160; economy of, in steam vessels, 403.
- Funnel casing, 344.
- Funnel, what to do if carried away, 533.
- Funnels of steam boats. *See* Chimneys.
- Furnaces, proper mode of firing, 94; smoke burning: Williams's argand, 97; Pridoux's, 97-100; Boulton and Watt's dead plate, 101; revolving grate, 101; Juckes's 102; Maudslay's, 103; Hall's, Coupland's, Godson's, Robinson's, Stevens's, Hazeldine's, &c., 104.
- Furnaces of marine boilers, proper length of, 236.
- Furnace bridges, benefits of, 238.
- Fusible metal plugs useless as antidotes to explosions, 199.
- Gardiner and Macintosh's portable engine, 471.
- Garrett and Son's portable engine, 463, 464.
- Gauges, vacuum, 6; steam, 6; gauge cocks and glass tubes for showing level of water in boiler, description of, 6.
- Gauge cocks for showing level of water in boiler, 6. 153. 314.
- Geirring for screw engines, 75.
- Geared oscillating screw engine, description of, 76.
- Gibs and cutters, strength proper for, 229.
- Glass tubes for showing water level in boilers, 6. 153.
- Glass tube cocks, 315.
- Gonzenbach, expansion valve by, 130.
- Gooch's indicator, 149-151.
- Gooch's locomotive, 447.
- Governor or conical pendulum, 20, 21; description of, 54.
- Gravity, centre of, 15.
- "Great Britain," engines of, 76.
- "Great Western," boilers of, by Messrs. Maudslay, 159.
- Gridiron valve, 296.
- Griffith's screw, 396.
- Grinding corn, power necessary for, 499-501.
- Grinding of cylinders, 509.
- Gudgeons, strength proper for, 219.
- Guides of locomotives, 344.
- Guides of direct acting screw engine, 434.
- Gun metal, strength of, 34.
- Gyrations, centre of, 15.
- Harvey and West's pump valves, 273.
- Hawthorn, expansion valve by, 130.
- Heat, latent, definition of, 87.
- Heat, specific definition of, 89.
- Heat, Regnault's experiments on, 89.
- Heat, loss of, by blowing off marine boilers, 250.
- Heating surface of boilers, 158.
- Heating surface per square foot of fire bars in locomotives, 142; a cubic foot of water evaporates by five square feet of heating surface, 142.
- Heating of bearings, causes of, 334; bearings should always be slack at the sides, else the pressure is infinite.
- High pressure engine, definition of, 1.
- High pressure engines, power of, 134.
- High speed engines, 126; arrangements proper for high speeds, 127.
- Hodgson's screw, 396.
- Holding down bolts of marine engines, or bolts for securing engines to hull, 67.
- Holm's screw propeller, 397. 446.
- Hornby and Son's portable engine, 468; fixed engine, 467.
- Horizontal engines by Ransomes and Sims; Clayton, Shuttleworth, and Co.; Turner; and Barrett, Exall, and Andrewes, 477-481.
- Horse power, definition of, 131; nominal horse power, 132-139; actual power ascertained by the indicator, 132-139; Admiralty rule for, 138.
- Hot water or feed pump, description of, 58. 67.
- Hot wall, description of, 58.
- Inclined plane, 22.
- Increasing pitch of screw, 380.
- Incrustation in boilers, 246. *See* also Salt.
- India rubber valves for air pump, 302-306.
- Indicator, description of the, 132; by M'Naught, structure and mode of using, 144-149; Gooch's continuous indicator, 149-151.
- Injection cock, 58. 70.
- Injection cocks of marine engines at ship's sides, 313.
- Injection orifice, proper area of, 311.

- Injection valve, 313.
 Inside cylinder locomotives, 339.
 Inverted engine by Bach, 488; by Nasmyth, 489.
 Iron, strength of, 33—36; limits of elasticity of, 35, 36; proper strain to be put upon iron in engines and machines, 37; aggravation of strain by being intermittent, 39; increase of strain due to deflection, 40; strength of pillars and tubes, 42, 43; combination of malleable and cast iron, 44.
 Iron cast, strength of, 33—36; cast iron beams, 39—41; may be strong to resist strains, but not strong to resist shocks, 43; should be combined with wrought iron to obtain maximum strength, 44.
 Iron, if to be case hardened, should be homogeneous, 516.
 Jacket of cylinder, advantages of, 116, 288.
 Joints, rust, how to make, 514.
 Kingston's valves, 313.
 Lamb's scale preventer, 253.
 Lantern brass in stuffing boxes, 289.
 Lap and lead of the valve, meaning of, 119.
 Large vessels have least proportionate resistance, 368.
 Latent heat, definition of, 87.
 Lavagrian, expansion valve by, 129.
 Lead and lap of the valve, meaning of, 119.
 Lead of the valve, benefits of, 206, 207.
 Lever, 23; futility of plans for deriving power from a lever, 24.
 Lifting apparatus for screw propeller, 320.
 Limits of elasticity, 35.
 Links, main, description of, 61, 73, 128, 349.
 Link motion of direct acting screw engine, 445.
 Link motion, how to set, 526.
 Locomotive engines: general description of the locomotive, 80; Stephenson's locomotive, 81; Gooch's locomotive for the wide gauge, 83; Crampton's locomotive for the narrow gauge, 84.
 Locomotives, adhesion of wheels of, 331; cost and performance of, 332; framing of, 337; cylinders of, 338, 342; springs of, 338; outside and inside cylinders, 339; sinuous motion of, 339; rocking motion of, 339; pitching motion of, 341; pistons, 343; piston rods, 343; guides, 344; cranked axle, 345; axle bearings, 346; eccentrics, 347; eccentric rod, 348; starting handle, 349; link motion, 349; valves, how to set, 349; eccentrics, how to readjust, 351; feed pumps, 352; connexion of engine and tender, 353; driving wheels, 354; wheel tires, 356.
 Locomotive engine of modern construction, example of, 447; fire box, 447; barrel of boiler, 448; tubes, 448; tube plate, 448; framing, 449; axle guards, 449; draw bolt, 450; wheels and axles, 450; cylinders, 450; valve, 450; piston, 450; piston rod, 450; guides, 450; connecting rod, 450; eccentrics, 451; link motion, 451; regulator, 451; blast pipe, 451; safety valve, 451, 452; feed pump, 451, 452; tendencies of improvement in locomotives, 453.
 Locomotives, management of, 539—545.
 Locomotive boilers, examples of modern proportions, 173.
 Locomotive boilers, details of, 261.
 Low pressure or condensing engine definition of, 1.
 Lubrication of rubbing surfaces, 28; the friction depends mainly on the nature of lubricant, 28, 29; oil forced out of bearings if the pressure exceeds 800 lbs. per square inch longitudinal section, 30; water a good lubricant if the surfaces are large enough, 30.
 Lubrication of engine bearings, 537.
 M'Naught's indicator, 144—149.
 Main beam, strength proper for, 220.
 Main centre, description of, 67; strength proper for, 228.
 Main links, description of, 61; strength proper for, 218.
 Mandrils, expanding, for tubing boilers, 268.
 Manhole door, 48.
 Manhole of locomotives, 265.
 Marine flue boilers, proportions of 158—160. *See also* Boilers.
 Marine boilers of modern construction, proper proportions of, 174.
 Marine engines. *See* Steam Engines, marine.
 Mastic cement for setting marine boilers, 235.
 Maudslay, Messrs, boilers of "Retri-

- bution" and "Great Western," by, 159.
- Mechanical powers, 22; misconceptions respecting, 23, 24.
- Mechanical power, definition of, 25; indestructible and eternal, 25; the sun the source of mechanical power, 25.
- Metallic packing for pistons, 274, 291.
- Metallic packing for stuffing boxes, 294.
- Meyer, expansion valve by, 129.
- Miller, Ravenhill, and Co.'s, mode of fixing piston rod to piston, 294.
- Modern locomotives, 447.
- Momentum, or *vis viva*, 10, 11.
- Morin, experiments on friction by, 29.
- Mudholes of locomotives, 266.
- Munts's metal, composition of, 519.
- Nasmyth's inverted cylinder engine, 490.
- "Niger" and "Basillak," trials of, 388.
- "Nile," boilers of the, by Boulton and Watt, 164.
- Notch of eccentric should be fitted with brass bush, 299.
- Oils for lubrication, 28. See Lubrication.
- Oscillation, centre of, 15.
- Oscillating land engine by Tuxford, 486; by Crosskill, 487.
- Oscillating paddle engine, description of, 71.
- Oscillating geared screw engine, description of, 76.
- Oscillating engine, advantages of, 282; suitability of objections to, 283; details of cylinder, 412, 415, 430; framing, 412; condenser, 413; air pump, 414; trunnions, 415, 430; valve and valve casing, 417; piston, 418; piston rod, 419; air pump connecting rod and cross head, 420; air pump rod, 422; eccentric and eccentric rod, 423; valve gear, 424; valve sector, 425; shaft plummer blocks, 427; trunnion plummer blocks, 427; feathering paddle wheels, 428, 429; packing of trunnions, 432.
- Oscillating engines, how to erect, 523.
- Outside and inside cylinder locomotives, 339.
- Packing for stuffing box of Watt's engine, 60.
- Packing of piston of pumping engines, how to accomplish, 274.
- Packing of trunnions, 432.
- Paddle bolts, proper mode of forming, 323.
- Paddle centres, 322.
- Paddle floats, 323.
- Paddle shaft, description of, 69.
- Paddle shaft, details of, 324.
- Paddle shaft plummer blocks of oscillating engines, 427.
- Paddle wheels, details of, 321; structure and operation of, 369; slip of, 370; centre of pressure of, 371; rolling circle, 372; action of oblique floats, 376; rule for proportioning paddle wheels, 377; benefits of large floats, 378.
- Paddle wheels, feathering, description of, 73; details of, 428.
- Paddles and screw combined, 407.
- Parallel motion, description of, 61, 69; how to lay off centres of, 522.
- Pendulum, 17; cause of vibrations of, 18; relation of vibrations of pendulum to velocity of falling bodies, 19; conical pendulum, or governor, 20, 21.
- Penn, Messrs., engines of "Great Britain," by, 76; direct acting screw engines by, 78; trunk engines by, 78.
- Performance of locomotives, 332.
- Performance of portable engines, 475.
- "Peterhoff," engines of, 71.
- Pillars, hollow, strength of, 42; law of strength varies with thickness of metal, 43.
- Pillar or column engine, by Ferrabee, 490.
- Pipe for receiving screw shaft, 317.
- Pipes of marine engines, 315.
- Piston, description of, 54, 56; how to pack with hemp, 274.
- Pistons, metallic packing for, 274, 291.
- Pistons for oscillating engines, 283, 418.
- Pistons, how to fit and finish, 516.
- Pistons of locomotives, 343.
- Piston rod, description of, 54, 67; strength proper for, 218, 223.
- Piston rods of locomotives, 343.
- Piston rod of oscillating engine, 419.
- Piston rods of direct acting screw engine, 438.
- Pitch of the screw, 380.
- Pitch, increasing or expanding, 380.
- Pitching motion in locomotives, 344.
- Planometers, or face plates, 511.

- Plough, steam, by Usher, 498.
- Plummer blocks of shafts and trunnions of oscillating engines, 427.
- Plummer blocks for receiving thrust of screw propeller, 319, 443, 444.
- Plunger of feed pump, 310.
- Portable agricultural engines, 455.
- Portable engines, prices of, 475.
- Ports of the cylinder, area of, 205.
- Pot-lid valves of air pump, 300.
- Powers, mechanical, 22; misconceptions respecting, 23, 24.
- Power, horses, definition of, 131; nominal and actual power, 132-134; power of high pressure engines, 134.
- Power necessary for thrashing and grinding corn, working sugar mills, spinning cotton, sawing timber, pressing cotton, blowing furnaces, driving piles, and dredging earth out of rivers, 498-504.
- Pressing cotton, power necessary for, 503.
- Prices of portable engines, 475.
- Prices of fixed agricultural engines, 492.
- Priming, nature and causes of, 185-187.
- Priming, if excessive, may occasion explosion, 198.
- Propeller, screw, description of, 77.
- Proportions of screws with two, four, and six blades, 402-404.
- Proving of boilers, 232.
- Prussiate of potash for case hardening, 516.
- Pumping engines, mode of erecting, 271; mode of starting, 275.
- Pumps, loss of effect in, at high speed and with hot water, 110, 299; causes of this loss, 214; remedy for, 215.
- Pumps used for mines, 277.
- Pump, air, description of, 58; action of, 60.
- Pumps, air, proper proportions of, 207; single and double acting, 208.
- Pump, centrifugal, better than common pump, 280.
- Pump, cold water, description of, 59.
- Pump, feed, description of, 58; action of, 60; proper dimensions of, 169; rule for proportioning, 213; plunger of, 310; valves of, 310.
- Pump, steam, by Worthington and Baker, 496.
- Pump valves for mines, &c., 278, 279.
- Punching and shearing boiler plates, 234.
- Railway wheels, bursting velocity of, 15.
- Railway trains, resistance of, 188, 332-336.
- Ransomes and Sims' portable engine, 457; fixed engine, 477.
- Rarefaction or exhaustion produced by chimneys, 181.
- "Rattler" and "Alecto," trials of, 388.
- "Red Rover," engines of, 67.
- Registration, benefits of, 409.
- Regnault, experiments on heat by, 89, 105.
- Regulator, a valve for regulating the admission of steam in locomotives, description of, 81; various forms of, 269, 270.
- Rennie, experiments on friction by, 28.
- Rennie, Messrs., engines of steamer "Peterhoff" by, 71.
- Resistance, experienced by railway trains, 188, 332-336.
- Resistance of vessels in water, 359; mainly made up of friction, 361; experiments on, 363-368.
- Resistance and speed of vessels influenced by their size, 368.
- "Retribution," boilers of, by Messrs. Maudslay, 159.
- Riveting and caulking of land boilers, 232.
- Rocking motion of locomotives, 329.
- Rolling circle of paddle wheels, 372.
- Rotatory engines, definition of, 2.
- Rotative engines, definition of, 2.
- Rust joints, how to make, 514.
- Safety valve, description of, 69; of locomotives, 81; area of, in low pressure engines, 201; in locomotives, 202, 451.
- Salinometer, or salt gauge, how to use, 528; how to construct, 529.
- Salt, accumulation of, prevented in marine boilers by blowing off, 7; if allowed to accumulate in boilers may occasion explosion, 200; amount of, in sea water, 248.
- Salt water produces surcharged steam, 257.
- Salting of boilers, what to do if this takes place, 529-531.
- Sawing timber, power necessary for, 503.
- Scale in marine boilers, 246. See also Salt.
- Scale preventer, Lamb's, 253.

- Scrap iron, unsuitable for case hardening, 516.
- Scraping tools for metal surfaces, 510.
- Screw, 22.
- Screw engine, geared oscillating, description of, 76; direct acting, description of, 79.
- Screw engine, direct acting, by Messrs. John Bourne and Co., 433.
- Screw engines, best forms of, 285.
- Screw frame in deadwood, 318.
- Screw propeller, description of, 77.
- Screw propeller, mode of fixing on shaft, 317; modes of receiving thrust, 319; apparatus for lifting, 320; configuration of, 379; action of, 379; pitch of the screw, 380; screws of increasing or expanding pitch, 380; slip of the screw, 381; positive and negative slip, 382; screw and paddles compared, 383; test of the dynamometer, 387; trials of "Rattler" and "Alecto," and "Niger" and "Basillisk," 388; indicator and dynamometer power, 390; loss of power in screw vessels in head winds, 391; the screw should be deeply immersed, 394; screws of the Earl of Dundonald, Hodgson, Griffith, Holm, and Beattie, 396—400; lateral and retrogressive slip, 400; sterns of screw vessels should be sharp, 401; proportions of screws with two, four, and six blades, 402—404; screw vessels with auxiliary power, 405; screw and paddles combined, 407; economy of fuel in steam vessels, 409; benefits of registration, 409.
- Screw propeller, Holm's conchoidal, 448.
- Screw shaft, details of, 317.
- Screw shaft pipe at stern, 317, 443.
- Screw shaft brasses of direct acting screw engines, 435.
- Sea water, amount of salt in, 248.
- Sea Injection cocks, 313.
- Sector for valve of oscillating engine, 425.
- Setting of wagon boilers, 233; of marine boilers, 235.
- Setting the valves of locomotives, 349.
- Shaft, paddle, details of, 324.
- Shaft of screw propeller, details of, 317.
- Shafts, strength of, 221, 222, 226.
- Shank's steam gauge, 144.
- Shocks may not be well resisted by iron that can well resist strains, 43; effect of inertia in resisting shocks, 43.
- Side levers or beams, description of, 67.
- Side lever marine engines, description of, 67—70.
- Side lever engines, how to erect, 519—523.
- Side rods, description of, 67; strength proper for, 224.
- Single acting engines, definition of, 2.
- Single acting or pumping engines, mode of erecting, 271; mode of starting, 275.
- Sinuous motion of locomotives, 332.
- Slide valve, 67; various forms of, 116; long D and three ported valve, description of, 117; action of the slide valve, 118; lead and lap of the valve, 119; rules for determining the proportions of valves, 120, 121. advantages of lead in swift moving engines, 122.
- Slide valve, equilibrium, 294—297.
- Slide valve with balance piston of direct acting screw engine, 457.
- Slide valve, how to finish, 512, 513.
- Slide valves of marine engines, how to set, 525.
- Slip of paddle wheels, 370.
- Slip of the screw, 381; positive and negative slip, 382; lateral and retrogressive slip, 400.
- Smoke, modes of consuming, 96—104.
- Smoke burning furnaces: Williams's argand, 97; Pridcaux's, 97—100; Boulton and Watt's dead plate, 101; revolving grate, 101; Jukes's, 102; Maudslay's, 103; Hall's, Coupland's, Godson's, Robinson's, Stevens's, Haseldine's, &c., 104.
- "Snake" locomotive, 447.
- Southern, experiments on friction by, 28; experiments on steam by, 105.
- Specific heat, definition of, 89.
- Speed of vessels influenced by their size, 368.
- Spheroidal condition of water in boilers, 197.
- Springs of locomotives, 338.
- Stand pipe for low pressure boilers, 48, 49, 155.
- Starting handle of locomotives, 349.
- Staying of boilers, 193, 194, 195.
- Staying tube plates, mode of, 242.
- Staying fire boxes of locomotives, 262.
- Steam, experiments on by Southern, French Academy, Franklin Institute, and M. Regnault, 105.

- Steam and water, relative bulks of, 108.
- Steam, expansion of, 111; pressure of, inversely as space occupied, 112. See also Expansion of Steam.
- Steam engine: general description of Watt's double acting engine, 54.
- Steam engine, various forms of, for propelling vessels, 65-80; paddle engines and screw engines, 65; principal varieties of paddle engines, 65; different kinds of paddle wheels, 66; the side lever engine, 66; description of the side lever engine, 67-70; oscillating paddle engine, 71; description of feathering paddle wheels, 73; oscillating geared screw engine, 76; direct acting screw engine, 78.
- Steam dome of locomotives, 265.
- Steam gauge, 6, 143; Bourdon's, 143; Shank's, 144.
- Steam jacket, benefits of, 116, 288.
- Steam passages, area of, 203-205.
- Steam plough, Usher's, 493.
- Steam pump, Worthington and Baker's, 496.
- Steam room in boilers, 183-185.
- Steam, surcharged, law of expansion by heat, 108.
- Steel, strength of, 34.
- Stephenson, link motion by, 127.
- Stop valves between boilers, 258.
- Straight edges, 511.
- Strains subsisting in machines, 33.
- Strain proper to be put upon iron in engines, 37.
- Strains in machines vary inversely as the velocity of the part to which the strain is applied, 38; aggravated by being intermittent, 39; increase of strain due to deflection, 40; effects of alternate strains in opposite directions, 41.
- Strength of materials, 33.
- Strength of hollow pillars, 42; law of strength varies with thickness of metal, 43.
- Strength of cast iron to resist shocks does not vary as the strength to resist strains, 43; increase of strength by combination with cast iron, 44.
- Strength of boilers, 189; experiments on, by Franklin Institute, 190; by Mr. Fairbairn, 191; mode of computing, 191, 192; mode of staying for strength, 193, 194.
- Strengths of engines: cylinder, 217; trunnions, 217; piston rod, 218, 223; main links, 218; connecting rod, 218, 224; studs of the beam, 219; gudgeons, 219; working beam, 220; cast iron shaft, 221, 222; malleable iron shaft, 226; teeth of wheels, 222; side rods, 224; crank, 224-226; crank pin, 227; cross head, 227; main centre, 228; gibs and cutters, 229.
- Studs, strength proper for, 219.
- Stuffing box, description of, 60.
- Stuffing boxes with metallic packing 290; with sheet brass packed behind with hemp, 290; sometimes fitted with a lantern brass, 289.
- Sugar mills, power necessary to work, 501.
- Summers' experiments on the friction of rough surfaces, 32.
- Surcharged steam, law of expansion of, by heat, 108.
- Surcharged steam produced by salt water, 257; corrosive action of, 257.
- Surfaces, how to make true, 511.
- Sweeping the tubes of boilers clean of soot, 532.
- Table engine by Tuxford, 484.
- Teeth of wheels, 222.
- Telescope chimneys, 245.
- Tender of a locomotive, description of, 83; attachment of, to engine, 353.
- Thrashing corn, power necessary for, 498.
- Throttle valve, description of, 54.
- Thrust of the screw propeller, modes of receiving, 319.
- Thrust plummer block, 443, 444.
- Tires of locomotive wheels, 356.
- Traction on railways, 330.
- Trunk engine by Messrs. Rennie, disadvantages of, 285.
- Trunk engines by Messrs. Penn, 78.
- Trunnions of oscillating engines, description of, 71; strength proper for, 217; details of, 415.
- Trunnion packing, 432.
- Trunnion plummer blocks, 427.
- Tube plates, mode of staying, 242.
- Tube plates of modern locomotives, 443.
- Tubes of modern locomotive boilers, 448.
- Tubes of boilers, how to sweep clean of soot, 532.
- Tubing of boilers, 241.
- Tubing locomotive boilers, 268.
- Turner's portable engine, 466; performance of, 467; fixed engine, 479.

- Tuxford and Sons' portable engine, 468, 470, 471; table engine, 484; double side rod, 485; oscillating, 486.
- Usher's steam plough, 493.
- Valve, atmospheric, 48.
- Valve casing, description of, 56.
- Valve casing should have expansion joint, 299.
- Valve and valve casing of oscillating engine, 417.
- Valve delivery, description of, 58; action of, 60.
- Valve, equilibrium slide, 294—297.
- Valve, foot, description of, 58; action of, 60.
- Valve gear of Watt's engine, 57; action of, 59.
- Valve gear of oscillating engine, 424.
- Valve, gridiron, 296.
- Valve sector of oscillating engines, 425.
- Valve, slide. *See* Slide Valve.
- Valve, slide, how to finish, 512, 513.
- Valves, ball, 352; Belidor's, might be used for foot and delivery valves, 300; butterfly, of air pump, 300; concentric ring, for air pump bucket, 301.
- Valves, escape, for cylinders, 290.
- Valves, expansion. *See* Expansion Valves.
- Valves of feed pumps, 310.
- Valves, india rubber, for air pump, 292—296.
- Valves, Kingston's, 313.
- Valves of locomotives, how to set, 349.
- Valves, pot-lid, of air pump, 370.
- Vacuum, meaning of, 1; nature and uses of, 4; how maintained in engines, 4.
- Vacuum sometimes occurs in boilers, 6; evils of a vacuum in boilers, 7.
- Vacuum, velocity with which air rushes into a, 7.
- Vacuum gauge, 6, 143; Bourdon's, 143.
- Velocity of air entering a vacuum, 7.
- Velocity of falling bodies, 8.
- Vent of boilers, definition of, 161.
- Vessels, resistance of, 359; mainly made up of friction in good form, 361; experiments on, 363—368; influence of size, 368.
- Vis viva*, or mechanical power, 10, 11.
- Waste steam pipe, 244.
- Waste water pipe, 313, 314.
- Water required for condensation, 201; pumps for supplying, 215.
- Watt's double acting engine, description of, 54.
- Wedge, 22.
- Wheels, toothed, for screw engines, 73.
- Wheels, teeth of, 222.
- Wheels of locomotives, adhesion of, 331.
- Wheels, driving, of locomotives, 354.
- Wheel tires, 326.
- Wheels and axles of modern locomotives, 450.
- Wood, experiments on friction by, 28.
- Wood, evaporative efficacy of, 93.
- Working beam of land engine, description of, 51.
- Worthington and Baker's steam pump, 496.

LONDON

PRINTED BY SPOTTISWOODE AND CO.

NEW-STREET SQUARE

**NEW, ENLARGED, & GREATLY IMPROVED EDITION
OF THE ARTISAN CLUB'S TREATISE ON
THE STEAM-ENGINE.**

In One Volume, 4to. with 37 Plates and 546 Engravings on
Wood (200 new in the Fifth Edition), price 42s.

**TREATISE
ON
THE STEAM-ENGINE**

**IN ITS VARIOUS APPLICATIONS TO MINES, MILLS,
STEAM NAVIGATION, RAILWAYS, AND AGRICULTURE; WITH
THEORETICAL INVESTIGATIONS RESPECTING THE MOTIVE POWER
OF HEAT, AND THE PROPORTIONS OF STEAM-ENGINES; TABLES
OF THE RIGHT DIMENSIONS OF EVERY PART; AND PRACTICAL
INSTRUCTIONS FOR THE MANUFACTURE AND MANAGEMENT
OF EVERY SPECIES OF ENGINE IN ACTUAL USE.**

By JOHN BOURNE, C.E.

BEING

The Sixth Edition of the *Artisan Club's Treatise on the Steam-Engine.*

CRITICAL OPINIONS OF THE FIFTH EDITION.

'WHILE many books have been usefully composed to make the general public acquainted with that power which is changing the face of our country, and altering many of the conditions of society, the Artisan Club's Treatise on the Steam-Engine has steadily advanced in the esteem of those persons who need a more thorough and working acquaintance with the subject. The claims of this work have always been based on its practical character. It originally appeared in parts, with the defects of form and arrangement incident to that mode of publication; besides this disadvantage, its literal shortcomings were conspicuous; yet the amount of solid information in which it abounded, and its practical tendency, which the mechanical members of the profession were quick to recognise, insured for it great success. In this fifth edition, the original treatise is so changed by exclusion, amplification, and amendment, that the work is substantially new. It is, in fact, a system of elaborate treatises on the scientific principles which govern the steam-engine, and their practical application to its several parts in construction; and with its 37 plates and 546 woodcuts (200 new in this edition), added to its extensive tables, it forms a truly cyclopaedian monograph. In offering it to the public as the maturer product of his skill, its experienced Author says — *If this work is to be superseded by a better one, it must be written by some other person than me; for, upon the whole, it is as good a work as I am able to write on the subject.* It is indeed difficult to conceive anything more complete and exhaustive.'

DAILY NEWS.

London: LONGMAN, GREEN, and CO. Paternoster Row.

'THIS reproduction of the Artisan Club's Treatise on the Steam-Engine contains so many additions and emendations as to render the work substantially a new one. The new edition extends to 495 closely-printed pages. . . . The work is admirably arranged; a large number of new plates and woodcuts has been added; and it has been carefully indexed, so that all the information contained in it is easily accessible. The size, fulness, and accuracy of the volume are the best evidences of the great labour which the Author has bestowed upon it, and of his practical acquaintance with the subject; and we can congratulate him upon accomplishing his task of embodying in this treatise the best information on the subject of the steam-engine which at presents exists.'

MECHANICS' MAGAZINE.

'THE first edition of this great work was brought out in parts in 1846, with many imperfections, clearly discerned by its Editor. These defects were so compensated by novel and sterling qualities, that the book at once commended itself to the favour of practical men, and has retained its position ever since. The present edition is to a great extent a new work, cleared of the faults which disfigured the original, and retaining only those parts which continue to represent the present state of the topics of which they treat. Mr. Bourne himself is satisfied with the treatise as it now stands. *If this work, he says in his preface, is to be superseded by a better one, it must be written by some other person than me; for, upon the whole, it is as good a work as I am able to write on the subject.* The volume is furnished with elaborate tables, and no less than 37 plates and 546 woodcuts, of which 200 are new in this edition. We suppose it is impossible that in the present state of the arts the work could have been got up in a more appropriate or satisfactory manner.'

SPECTATOR.

'THE fifth edition of the invaluable work on the steam-engine drawn up under the revision of the Artisan Club has just been published, with the information brought down to the present time by Mr. J. BOURNE, the original Editor, and so many additions and emendations as to entitle the volume to be considered a new treatise. Mr. Bourne declares that most of the faults in the original work have been cleared away, and that he has spared no pains to render the present edition serviceable to the reader, and a fair embodiment of the best information which at present exists on the subject of the steam-engine. To dilate upon the merits of a work so well known as the Artisan Club's Treatise on the Steam-Engine would be useless; but for those persons who, owing to their brief connexion with the engineering profession, are unacquainted with the book, we may state that the history of the steam-engine, and its gradual improvement from the earliest period of which we have any record, to the present time, is carefully and judiciously given, and that every point connected with the practical details of the steam-engine is fairly and dispassionately discussed. Beyond this we need only refer to the subjects treated of in the several chapters—the scientific principles, the general theory, and the proportions of the steam-engine; on boilers; on pumping, mill, marine, locomotive, and agricultural engines; steam navigation; projects of improvement in the steam-engine; and rules and tables for finding the proper proportions of steam engines. To these is added an appendix containing all the theoretical data likely to be required by the practical engineer. The whole of the information given is rendered particularly lucid by the carefully executed illustrations which accompany the volume. As a treatise for practical men the work is as near perfection as any that has yet been published, and will, doubtless, long maintain the high reputation which its acknowledged merits have secured for it.'

MINING JOURNAL.

London: LONGMAN, GREEN, and CO. Paternoster Row.

BOOKS ON SCIENTIFIC

LOWNDES'S ENGINEER'S HANDBOOK Principles which should guide the young Engineer amongst other matters the Rule for Calculating Boilers, the comparative economical effect of Principles which regulate the Speed of Steam V, Post 8vo. 5s.

USEFUL INFORMATION for ENGINEERS FAIRBAIRN, C.E. F.R.S. F.G.S. New Editions of with numerous Plates and Woodcuts. 2 vols. 8vo.

FAIRBAIRN'S TREATISE on MILLWRIGHTS VOL. I. the Principles of Mechanism and Prime Construction, price 16s. VOL. II. Machinery, price 16s. 2 vols. 8vo. 32s.

THE APPLICATION of CAST and WROUGHT IRON BUILDING PURPOSES. By WILLIAM FAIRBAIRN, C.E. Third Edition, corrected and enlarged; and containing Wrought Iron Bridges, with 6 Plates and 118 Engravings.

IRON-SHIP BUILDING, its HISTORY and its Strength, Disposition, and Properties of the Projectiles at High Velocities. By WILLIAM FAIRBAIRN, C.E. as comprised in a Series of Experimental researches, and the Results of an Inquiry into the Resisting Power of Iron Plates and 118 Engravings.

ENCYCLOPÆDIA of CIVIL ENGINEERING. Theoretical, and Practical. By EDWARD FAIRBAIRN, C.E. 8vo. 42s. New and cheaper impression, with 118 Engravings.

PRACTICAL GEOMETRY: Containing all the most useful Geometrical Problems, with Construction and Use of the most essential Instruments. By THOMAS TATE, F.R.A.S. Second Edition. With 124 Woodcuts and Diagrams. 8vo. 12s.

ORTHOGRAPHIC PROJECTION DRAWING, as applied to Building, Architecture, and Mechanical Drawing. By S. BIRNS, M.C.P. With 124 Woodcuts and Diagrams. 8vo. 12s.

THE ELEMENTS of MECHANISM of Applied Mechanics. By T. M. GOODEVE, M.A. Royal Military Academy, Woolwich. Second Edition. Post 8vo. with 217 Figures on Wood, price 6s. 6d.

GWILT'S ENCYCLOPÆDIA of APPLIED MECHANICS. Theoretical, and Practical. With more than 2000 Designs by J. S. Gwilt. Fourth Edition. 8vo. 42s.

MANUAL of the METALLOIDS. By **JAMES APJOHN**, M.D. F.R.S. M.R.I.A. Professor of Chemistry in the University of Dublin. Edited by the Rev. **J. A. GALBRAITH**, M.A. and the Rev. **S. HAUGHTON**, M.D. Fcp. 8vo. with 38 Woodcuts, price 7s. 6d.

A TREATISE on ELECTRICITY, in THEORY and PRACTICE. By **A. DE LA RIVE**, Professor in the Academy of Geneva. Translated for the Author by **C. V. WALKER**, F.R.S. With Illustrations. 3 vols. 8vo. £3 13s.

OUTLINES of ASTRONOMY. By **Sir J. F. W. HERSCHEL**, Bart. M.A. Seventh Edition, revised; with Plates and Woodcuts. 8vo. 18s.

HEAT CONSIDERED as a MODE of MOTION. By **JOHN TYNDALL**, F.R.S. Professor of Natural Philosophy in the Royal Institution and in the Royal School of Mines. Second Edition, revised, with Additions. Crown 8vo. with 102 Figures, 12s. 6d.

THE ELEMENTS of CHEMISTRY, THEORETICAL and PRACTICAL. By **WILLIAM ALLEN MILLER**, M.D. LL.D. F.R.S. F.G.S. Professor of Chemistry in King's College. Revised Edition. 3 vols. 8vo. £2 13s.

Part I. **CHEMICAL PHYSICS.** 3rd Edition, 12s.

.. II. **INORGANIC CHEMISTRY.** 3rd Edition, 21s.

.. III. **ORGANIC CHEMISTRY.** 2nd Edition, 20s.

WATTS' DICTIONARY of CHEMISTRY and the ALLIED BRANCHES of OTHER SCIENCES; founded on that of the late **Dr. URE**. By **HENRY WATTS**, B.A. F.C.S. assisted by eminent Contributors. VOL. I. price 31s. 6d.; VOL. II. 26s.; and VOL. III. price 31s. 6d. are now ready.

DR. URE'S DICTIONARY of ARTS, MANUFACTURES, and MINES. Fifth Edition, rewritten and enlarged. Edited by **ROBERT HUNT**, F.R.S. F.S.S. Keeper of Mining Records, &c. assisted by eminent Contributors. With about 2,000 Wood Engravings. 3 vols. 8vo. price £1.

BRANDE'S DICTIONARY of SCIENCE, LITERATURE, and ART; Comprising the Definitions and Derivations of the Scientific Terms in general use, together with the History and Descriptions of the Scientific Principles of nearly every branch of Human Knowledge. Fourth Edition, reconstructed and extended under the editorship of **W. T. BRANDE**, D.C.L. F.R.S.L. & E. and of the Rev. **G. W. COX**, M.A. assisted by Gentlemen of eminent Scientific and Literary Attainments. In course of publication in 12 Monthly Parts, each containing 240 pages, price 5s. forming 3 vols. medium 8vo. price 21s. each.

LIFE of ROBERT STEPHENSON, F.R.S. By **J. C. JEAFFRESON**, Barrister-at-Law; and **WILLIAM POLE**, F.R.S. Member of the Institution of Civil Engineers. With 2 Portraits and 17 Illustrations on Steel and Wood. 2 vols. 8vo. 32s.

London: **LONGMAN, GREEN, and CO.** Paternoster Row.

- LECTURES on the HISTORY of ENGLAND.** By WILLIAM LONGMAN. VOL. I. from the earliest times to the Death of King Edward II. with 6 Maps, a coloured Plate, and 53 Woodcuts. 8vo. 15s.
- A CHRONICLE of ENGLAND,** from B.C. 55 to A.D. 1485; written and illustrated by J. E. DOYLE. With 81 Designs engraved on Wood and printed in Colours by E. Evans. 4to. 42s.
- HISTORY of CIVILISATION.** By HENRY THOMAS BUCKLE. 2 vols. 8vo. £1 17s.
VOL. I. *England and France*, Fourth Edition, 21s.
VOL. II. *Spain and Scotland*, Second Edition, 16s.
- DEMOCRACY in AMERICA.** By ALEXIS DE TOCQUEVILLE. Translated by HENRY REEVE, with an Introductory Notice by the Translator. 2 vols. 8vo. 21s.
- The SPANISH CONQUEST in AMERICA,** and its Relation to the History of Slavery and to the Government of Colonies. By ARTHUR HELPS. 4 vols. 8vo. £3. VOLS. I. and II. 28s. VOLS. III. and IV. 16s. each.
- HISTORY of the REFORMATION in EUROPE** in the Time of Calvin. By J. H. MERLE D'AUBIGNÉ, D.D. VOLS. I. and II. 8vo. 28s. and VOL. III. 12s.
- LIBRARY HISTORY of FRANCE,** in 5 vols. 8vo. By EYRE EVANS CROWE. VOL. I. 14s. VOL. II. 15s. VOL. III. 18s. VOL. IV. nearly ready.
- LECTURES on the HISTORY of FRANCE.** By the late Sir JAMES STEPHEN, LL.D. 2 vols. 8vo. 24s.
- The HISTORY of GREECE.** By C. THIRLWALL, D.D., Lord Bishop of St. David's. 8 vols. 8vo. £3; or in 8 vols. fcp. 28s.
- The TALE of the GREAT PERSIAN WAR,** from the Histories of Herodotus. By GEORGE W. COX, M.A. late Scholar of Trin. Coll. Oxon. Fcp. 7s. 6d.
- ANCIENT HISTORY of EGYPT, ASSYRIA, and BABYLONIA.** By the Author of 'Amy Herbert.' Fcp. 6s.
- CRITICAL HISTORY of the LANGUAGE and LITERATURE of Ancient Greece.** By WILLIAM MURE, of Caldwell. 5 vols. 8vo. £3 9s.
- HISTORY of the LITERATURE of ANCIENT GREECE.** By Professor K. O. MÜLLER. Translated by the Right Hon. Sir GEORGE CORNEWALL LEWIS, Bart. and by J. W. DONALDSON, D.D. 3 vols. 8vo. 36s.
- HISTORY of the ROMANS under the EMPIRE.** By CHARLES MERIVALE, B.D. Chaplain to the Speaker.
CABINET EDITION, 8 vols. post 8vo. 42s.
LIBRARY EDITION, 7 vols. 8vo. £5 11s.
- The FALL of the ROMAN REPUBLIC: a Short History of the Last Century of the Commonwealth.** By the same Author. 12mo. 7s. 6d.

The CONVERSION of the ROMAN EMPIRE: the Boyle Lectures for the year 1864, delivered at the Chapel Royal, Whitehall. By CHARLES MERRIVALE, B.D. Chaplain to the Speaker. Second Edition, 8vo. 8s. 6d.

CRITICAL and HISTORICAL ESSAYS contributed to the *Edinburgh Review*. By the Right Hon. LORD MACAULAY.

LIBRARY EDITION, 3 vols. 8vo. 36s.

TRAVELLER'S EDITION, in 1 vol. 21s.

In POCKET VOLUMES, 3 vols. fcp. 21s.

PEOPLE'S EDITION, 2 vols. crown 8vo. 6s.

HISTORICAL and PHILOSOPHICAL ESSAYS. By NASSAU W. SENIOR. 2 vols. post 8vo. 16s.

HISTORY of the RISE and INFLUENCE of the SPIRIT of RATIONALISM in EUROPE. By W. E. H. LECKY, M.A. Second Edition, revised. 2 vols. 8vo. 25s.

The BIOGRAPHICAL HISTORY of PHILOSOPHY, from its Origin in Greece to the Present Day. By GEORGE HENRY LEWES. Revised and enlarged Edition. 8vo. 16s.

HISTORY of the INDUCTIVE SCIENCES. By WILLIAM WHEWELL, D.D. F.R.S. Master of Trin. Coll. Cantab. Third Edition. 3 vols. crown 8vo. 24s.

EGYPT'S PLACE in UNIVERSAL HISTORY; an Historical Investigation. By C. C. J. BUNSEN, D.D. Translated by C. H. COTTRELL, M.A. With many Illustrations. 4 vols. 8vo. £5 8s. VOL. V. is nearly ready, completing the work.

MAUNDER'S HISTORICAL TREASURY; comprising a General Introductory Outline of Universal History, and a series of Separate Histories. Fcp. 10s.

HISTORICAL and CHRONOLOGICAL ENCYCLOPEDIA, presenting in a brief and convenient form Chronological Notices of all the Great Events of Universal History. By B. B. WOODWARD, F.S.A. Librarian to the Queen. [*In the press.*]

HISTORY of the CHRISTIAN CHURCH, from the Ascension of Christ to the Conversion of Constantine. By E. BURTON, D.D. late Regius Prof. of Divinity in the University of Oxford. Eighth Edition. Fcp. 3s. 6d.

SKETCH of the HISTORY of the CHURCH of ENGLAND to the Revolution of 1688. By the Right Rev. T. V. SHORT, D.D. Lord Bishop of St. Asaph. Sixth Edition. Crown 8vo. 10s. 6d.

HISTORY of the EARLY CHURCH, from the First Preaching of the Gospel to the Council of Nicea, A.D. 325. By the Author of 'Amy Herbert.' Fcp. 4s. 6d.

The ENGLISH REFORMATION. By F. C. MASSINGBERD, M.A. Chancellor of Lincoln and Rector of South Ormsby. Third Edition, revised and enlarged. Fcp. 6s.

HISTORY of WESLEYAN METHODISM. By GEORGE SMITH, F.A.S. Fourth Edition, with numerous Portraits. 3 vols. cr. 8vo. 7s. each.

LECTURES on the HISTORY of MODERN MUSIC, delivered at the Royal Institution. By JOHN HULLAH, Professor of Vocal Music in King's College and in Queen's College, London. **FIRST COURSE**, with Chronological Tables, post 8vo. 6s. 6d. **SECOND COURSE**, on the Transition Period, with 40 Specimens, 8vo. 16s.

Biography and Memoirs.

- LETTERS and LIFE of FRANCIS BACON**, including all his Occasional Works. Collected and edited, with a Commentary, by J. SPEDDING, Trin. Coll. Cantab. VOLS. I. and II. 8vo. 24s.
- PASSAGES from the LIFE of a PHILOSOPHER.** By CHARLES BABBAGE, Esq. M.A. F.R.S. &c. 8vo. 12s.
- LIFE of ROBERT STEPHENSON, F.R.S.** By J. C. JEAFFRESON, Barrister-at-Law; and WILLIAM POLE, F.R.S. Memb. Inst. Civ. Eng. With 2 Portraits and 17 Illustrations. 2 vols. 8vo. 32s.
- LIFE of the DUKE of WELLINGTON.** By the Rev. G. R. GLEIG, M.A. Popular Edition, carefully revised; with copious Additions. Crown 8vo. with Portrait, 5s.
- Brialmont and Gleig's Life of the Duke of Wellington.** 4 vols. 8vo. with Illustrations, £2 14s.
- Life of the Duke of Wellington**, partly from the French of M. BRIALMONT, partly from Original Documents. By the Rev. G. R. GLEIG, M.A. 8vo. with Portrait, 15s.
- HISTORY of MY RELIGIOUS OPINIONS.** By J. H. NEWMAN, D.D. Being the Substance of Apologia pro Vita Sua. Post 8vo. 6s.
- FATHER MATHEW: a Biography.** By JOHN FRANCIS MAGUIRE, M.P. Popular Edition, with Portrait. Crown 8vo. 3s. 6d.
- Rome; its Rulers and its Institutions.** By the same Author. New Edition in preparation.
- MEMOIRS, MISCELLANIES, and LETTERS of the late LUCY Aikin**; including those addressed to Dr. Channing from 1836 to 1842. Edited by P. H. LE BRETON. Post 8vo. 8s. 6d.
- LIFE of AMELIA WILHELMINA SIEVEKING**, from the German. Edited, with the Author's sanction, by CATHERINE WINKWORTH. Post 8vo. with Portrait, 12s.
- LOUIS SPOHR'S AUTOBIOGRAPHY.** Translated from the German. 8vo. 14s.
- DIARIES of a LADY of QUALITY**, from 1797 to 1844. Edited, with Notes, by A. HAYWARD, Q.C. Second Edition. Post 8vo. 10s. 6d.

FELIX MENDELSSOHN'S LETTERS from *Italy and Switzerland*, and *Letters from 1833 to 1847*, translated by Lady WALLACE. New Edition, with Portrait. 2 vols. crown 8vo. 5s. each.

RECOLLECTIONS of the late **WILLIAM WILBERFORCE, M.P.** for the County of York during nearly 30 Years. By J. S. HARFORD, F.R.S. Second Edition. Post 8vo. 7s.

MEMOIRS of **SIR HENRY HAVELOCK, K.C.B.** By JOHN CLARK MARSHMAN. Second Edition. 8vo. with Portrait, 12s. 6d.

THOMAS MOORE'S MEMOIRS, JOURNAL, and CORRESPONDENCE. Edited and abridged from the First Edition by Earl RUSSELL. Square crown 8vo. with 8 Portraits, 12s. 6d.

MEMOIR of the Rev. **SYDNEY SMITH.** By his Daughter, Lady HOLLAND. With a Selection from his Letters, edited by Mrs. AUSTIN. 2 vols. 8vo. 23s.

VICISSITUDES of **FAMILIES.** By Sir BERNARD BURKE, Ulster King of Arms. FIRST, SECOND, and THIRD SERIES. 3 vols. crown 8vo. 12s. 6d. each.

ESSAYS in **ECCLIASTICAL BIOGRAPHY.** By the Right Hon. Sir J. STEPHEN, LL.D. Fourth Edition. 8vo. 14s.

BIOGRAPHICAL SKETCHES. By NASSAU W. SENIOR. Post 8vo. price 10s. 6d.

BIOGRAPHIES of **DISTINGUISHED SCIENTIFIC MEN.** By FRANÇOIS ARAGO. Translated by Admiral W. H. SMYTH, F.R.S. the Rev. B. POWELL, M.A. and R. GRANT, M.A. 8vo. 18s.

MAUNDER'S BIOGRAPHICAL TREASURY: Memoirs, Sketches, and Brief Notices of above 12,000 Eminent Persons of All Ages and Nations. Fcp. 10s.

Criticism, Philosophy, Polity, &c.

PAPINIAN: a Dialogue on State Affairs between a Constitutional Lawyer and a Country Gentleman about to enter Public Life. By GEORGE ATKINSON, B.A. Oxon. Serjeant-at-Law. Post 8vo. 5s.

ELEMENTS of **LOGIC.** By R. WHATELY, D.D. late Archbishop of Dublin. Ninth Edition. 8vo. 10s. 6d. crown 8vo. 4s. 6d.

Elements of **Rhetoric.** By the same Author. Seventh Edition. 8vo. 10s. 6d. crown 8vo. 4s. 6d.

English Synonymes. Edited by Archbishop WHATELY. 5th Edition. Fcp. 3s.

BACON'S ESSAYS with **ANNOTATIONS.** By R. WHATELY, D.D. late Archbishop of Dublin. Sixth Edition. 8vo. 10s. 6d.

LORD BACON'S WORKS, collected and edited by R. L. ELLIS, M.A.
J. SPEDDING, M.A. and D. D. HEATH. Vols. I to V. *Philosophical Works*,
5 vols. 8vo. £4 8s. VOLS. VI. and VII. *Literary and Professional Works*,
2 vols. £1 16s.

On **REPRESENTATIVE GOVERNMENT**. By JOHN STUART MILL.
Third Edition, 8vo. 9s. crown 8vo. 2s.

On **Liberty**. By the same Author. Third Edition. Post 8vo. 7s. 6d.
crown 8vo. 1s. 4d.

Principles of Political Economy. By the same. Sixth Edition.
2 vols. 8vo. 30s. or in 1 vol. crown 8vo. 5s.

A System of Logic, Ratiocinative and Inductive. By the same.
Fifth Edition. Two vols. 8vo. 25s.

Utilitarianism. By the same. Second Edition. 8vo. 5s.

Dissertations and Discussions. By the same Author. 2 vols. 8vo.
price 24s.

**Examination of Sir W. Hamilton's Philosophy, and of the Principal
Philosophical Question discussed in his Writings**. By the same Author.
Second Edition. 8vo. 14s.

MISCELLANEOUS REMAINS from the Common-place Book of
RICHARD WHEATELY, D.D. late Archbishop of Dublin. Edited by Miss E. J.
WHEATELY. Crown 8vo. 7s. 6d.

ESSAYS on the ADMINISTRATIONS of GREAT BRITAIN from
1783 to 1830. By the Right Hon. Sir G. C. LEWIS, Bart. Edited by the
Right Hon. Sir E. HEAD, Bart. 8vo. with Portrait, 15s.

By the same Author.

A Dialogue on the Best Form of Government, 4s. 6d.

Essay on the Origin and Formation of the Romance Languages,
price 7s. 6d.

Historical Survey of the Astronomy of the Ancients, 15s.

Inquiry into the Credibility of the Early Roman History, 2 vols.
price 30s.

On the Methods of Observation and Reasoning in Politics, 2 vols.
price 28s.

Irish Disturbances and Irish Church Question, 12s.

Remarks on the Use and Abuse of some Political Terms, 9s.

On Foreign Jurisdiction and Extradition of Criminals, 2s. 6s.

The Fables of Babrius, Greek Text with Latin Notes, PART I.
5s. 6d. PART II. 3s. 6d.

**Suggestions for the Application of the Egyptological Method to
Modern History**, 1s.

- OUTLINE of the NECESSARY LAW**
on Pure and Applied Logic. By the Most
bishop of York. Crown 8vo. 5s. 6d.
- The ELEMENTS of LOGIC.** By THOMAS
Peter's Coll. Cantab. 12mo. 4s. 6d.
- ANALYSIS of Mr. MILL'S SYSTEM of**
M.A. Fellow of Worcester College, Oxford.
- The ELECTION of REPRESENTATIVE;**
cipal; a Treatise. By THOMAS HARE, B.
with Additions. Crown 8vo. 6s.
- SPEECHES of the RIGHT HON. LORD**
Himself. 8vo. 12s.
- LORD MACAULAY'S SPEECHES on PA**
in 1831 and 1832. 16mo. 1s.
- A DICTIONARY of the ENGLISH LANGUAGE**
M.A. M.D. F.R.S. Founded on the Dictionary
by the Rev. H. J. TODD, with numerous
Publishing in 86 Parts, price 8s. 6d. each, to
- THESAURUS of ENGLISH WORDS and**
arranged so as to facilitate the Expression of
Composition. By P. M. ROGET, M.D. 14th
- LECTURES on the SCIENCE of LANGUAGE**
Institution. By MAX MÜLLER, M.A. Taylor
of Oxford. FIRST SERIES, Fourth Edition.
- The DEBATER;** a Series of Complete I
and Questions for Discussion. By F. ROWE.
- A COURSE of ENGLISH READING,**
capacity; or, How and What to Read. }
Fourth Edition. Fcp. 5s.
- MANUAL of ENGLISH LITERATURE,**
a Chapter on English Metres. By THOMAS
J. W. WALTER, B.D. Square crown 8vo. 1s.
- SOUTHEY'S DOCTOR,** complete in One V
J. W. WALTER, B.D. Square crown 8vo. 1s.
- HISTORICAL and CRITICAL COMMENT**
MENT; with a New Translation. By M.
Genesis, 8vo. 18s. or adapted for the General
16s. or adapted for the General Reader, 12s.
- A Hebrew Grammar, with Exercises.** E
lines with Exercises, 8vo. 12s. 6d. KEY, 5s.
and Constructions, 12s. 6d.

of *White and Riddle* (as above), by J. T. WHITE, M.A. Joint-Author. Medium 8vo. pp. 1,048, price 18s. cloth.

- A Diamond Latin-English Dictionary, or Guide to the Meaning, Quality, and Accentuation of Latin Classical Words.** By Rev. J. E. RIDDLE, M.A. 32mo. 2s. 6d.
- An ENGLISH-GREEK LEXICON**, containing all the Greek Words used by Writers of good authority. By C. D. YONGE, B.A. Fifth Edition. 4to. 21s.
- Mr. YONGE'S NEW LEXICON**, English and Greek, abridged from his larger work (as above). Square 12mo. 8s. 6d.
- A GREEK-ENGLISH LEXICON.** Compiled by H. G. LIDDELL, D.D. Dean of Christ Church, and R. SCOTT, D.D. Master of Balliol. Fifth Edition. Crown 4to. 31s. 6d.
- A Lexicon, Greek and English**, abridged from LIDDELL and SCOTT'S *Greek-English Lexicon*. Eleventh Edition. Square 12mo. 7s. 6d.
- A PRACTICAL DICTIONARY of the FRENCH and ENGLISH LANGUAGES.** By L. CONTANSEAU. Ninth Edition. Post 8vo. 10s. 6d.
- Contanseau's Pocket Dictionary, French and English**, abridged from the above by the Author. Third Edition, 18mo. 5s.
- NEW PRACTICAL DICTIONARY of the GERMAN LANGUAGE;** German-English and English-German. By the Rev. W. L. BLACKLEY, M.A. and Dr. CARL MARTIN FRIEDLANDER. Post 8vo. [In the press.]

Miscellaneous Works and Popular Metaphysics.

- RECREATIONS of a COUNTRY PARSON:** being a Selection of the Contributions of A. K. H. B. to *Fraser's Magazine*. SECOND SERIES. Crown 8vo. 3s. 6d.
- The Common-place Philosopher in Town and Country.** By the same Author. Crown 8vo. 3s. 6d.
- Leisure Hours in Town; Essays Consolatory, Æsthetical, Moral, Social, and Domestic.** By the same Author. Crown 8vo. 3s. 6d.
- The Autumn Holidays of a Country Parson; Essays contributed to *Fraser's Magazine* and to *Good Words*.** By the same. Crown 8vo. 3s. 6d.
- The Graver Thoughts of a Country Parson.** SECOND SERIES. By the same Author. Crown 8vo. 3s. 6d.
- Critical Essays of a Country Parson.** Selected from Essays contributed to *Fraser's Magazine*. By the same Author. Post 8vo. 9s.

CAMPAIGNER AT HOME. By SHIB.
and 'Nugæ Criticæ.' Post 8vo. with Vignets
FRIENDS in COUNCIL: a Series of Read
2 vols. fcp. 9s.

Friends in Council. SECOND SERIES.
Essays written in the Intervals of Busi

LORD MACAULAY'S MISCELLANEOU
LIBRARY EDITION. 2 vols. 8vo. Portrait,
PEOPLE'S EDITION. 1 vol. crown 8vo. 4s.

The REV. SYDNEY SMITH'S MISCELI
ing his Contributions to the *Edinburgh Re*
LIBRARY EDITION, 3 vols. 8vo. 36s.

TRAVELLER'S EDITION, in 1 vol. 21s.
IN POCKET VOLUMES, 3 vols. fcp. 21s.
PEOPLE'S EDITION, 2 vols. crown 8vo. 8s.

Elementary Sketches of Moral Philoso
Institution. By the same Author. Fcp. 7s

The Wit and Wisdom of the Rev. Sy
the most memorable Passages in his Writing

The HISTORY of the SUPERNATURAL
and in all Churches, Christian and Pagan; c
By WILLIAM HOWITT. 2 vols. post 8vo. 18s

The SUPERSTITIONS of WITCHCRAF
M.A. St. John's Coll. Camb. Post 8vo. 7s. 6

CHAPTERS on MENTAL PHYSIOLOGY
Bart. M.D. F.R.S. Second Edition. Post

ESSAYS selected from CONTRIBUTION
By HENRY ROGERS. Second Edition. 3 v

The Eclipse of Faith; or, a Visit to a
same Author. Tenth Edition. Fcp. 5s.

Defence of the Eclipse of Faith, by its
Newman's Reply. Third Edition. Fcp. 8v

Selections from the Correspondence of
same Author. Third Edition. Crown 8vo.

Fullerians, or the Wisdom and Wit of T
on his Life and Genius. By the same Auth

An INTRODUCTION to MENTAL PHIL
Method. By J. D. MORELL, M.A. LL.D. 8

Elements of Psychology, containing the
Powers. By the same Author. Post 8vo. 7s

- SIGHT and TOUCH**: an Attempt to Disprove the Received (or Berkeleyan) Theory of Vision. By THOMAS K. ABBOTT, M.A. Fellow and Tutor of Trin. Coll. Dublin. 8vo. with 21 Woodcuts, 5s. 6d.
- The SENSES and the INTELLECT.** By ALEXANDER BAIN, M.A. Professor of Logic in the University of Aberdeen. Second Edition. 8vo. price 15s.
- The Emotions and the Will**, by the same Author; completing a Systematic Exposition of the Human Mind. 8vo. 15s.
- On the Study of Character**, including an Estimate of Phrenology. By the same Author. 8vo. 9s.
- TIME and SPACE**: a Metaphysical Essay. By SHADWORTH H. HODGSON. 8vo. pp. 588, price 16s.
- HOURS WITH THE MYSTICS**: a Contribution to the History of Religious Opinion. By ROBERT ALFRED VAUGHAN, B.A. Second Edition. 2 vols. crown 8vo. 12s.
- PSYCHOLOGICAL INQUIRIES.** By the late Sir BENJ. C. BRODIE, Bart. 2 vols. or SERIES, fop. 5s. each.
- The PHILOSOPHY of NECESSITY**; or Natural Law as applicable to Mental, Moral, and Social Science. By CHARLES BRAY. Second Edition. 8vo. 9s.
- The Education of the Feelings and Affections.** By the same Author. Third Edition. 8vo. 3s. 6d.
- CHRISTIANITY and COMMON SENSE.** By Sir WILLOUGHBY JONES, Bart. M.A. Trin. Coll. Cantab. 8vo. 6s.
-

Astronomy, Meteorology, Popular Geography, &c.

- OUTLINES of ASTRONOMY.** By Sir J. F. W. HERSCHEL, Bart. M.A. Seventh Edition, revised; with Plates and Woodcuts. 8vo. 18s.
- ARAGO'S POPULAR ASTRONOMY.** Translated by Admiral W. H. SMYTH, F.R.S. and R. GRANT, M.A. With 25 Plates and 388 Woodcuts. 2 vols. 8vo. £2 5s.
- Arago's Meteorological Essays**, with Introduction by Baron HUMBOLDT. Translated under the superintendence of Major-General E. SABINE, R.A. 8vo. 18s.
- SATURN and its SYSTEM.** By RICHARD A. PROCTOR, B.A. late Scholar of St John's Coll. Camb. and King's Coll. London. 8vo. with 14 Plates, 14s.

The **WEATHER-BOOK**; a Manual of Practical Meteorology. By Rear-Admiral ROBERT FITZ ROY, R.N. F.R.S. Third Edition, with 16 Diagrams. 8vo. 15s.

SAXBY'S WEATHER SYSTEM, or Lunar Influence on Weather. By S. M. SAXBY, R.N. Instructor of Naval Engineers. Second Edition. Post 8vo. 4s.

DOVE'S LAW of **STORMS** considered in connexion with the ordinary Movements of the Atmosphere. Translated by R. H. SCOTT, M.A. T.C.D. 8vo. 10s. 6d.

CELESTIAL OBJECTS for **COMMON TELESCOPES**. By the Rev. T. W. WEBB, M.A. F.R.A.S. With Map of the Moon, and Woodcuts. 16mo. 7s.

PHYSICAL GEOGRAPHY for **SCHOOLS** and **GENERAL READERS**. By M. F. MAURY, LL.D. Fcp. with 2 Charts, 2s. 6d.

A **DICTIONARY**, Geographical, Statistical, and Historical, of the various Countries, Places, and Principal Natural Objects in the World. By J. R. M'CULLOCH. With 6 Maps. 2 vols. 8vo. 63s.

A **GENERAL DICTIONARY** of **GEOGRAPHY**, Descriptive, Physical, Statistical, and Historical: forming a complete Gazetteer of the World. By A. KEITH JOHNSTON, F.R.S.E. 8vo. 31s. 6d.

A **MANUAL** of **GEOGRAPHY**, Physical, Industrial, and Political. By W. HUGHES, F.R.G.S. Professor of Geography in King's College, and in Queen's College, London. With 6 Maps. Fcp. 7s. 6d.

The **Geography of British History**; a Geographical Description of the British Islands at Successive Periods. By the same. With 6 Maps. Fcp. 8s. 6d.

Abridged Text-Book of British Geography. By the same. Fcp. 1s. 6d.

The **BRITISH EMPIRE**; a Sketch of the Geography, Growth, Natural and Political Features of the United Kingdom, its Colonies and Dependencies. By CAROLINE BRAY. With 5 Maps. Fcp. 7s. 6d.

COLONISATION and **COLONIES**: a Series of Lectures delivered before the University of Oxford. By HERMAN MERIVALE, M.A. Professor of Political Economy. 8vo. 18s.

MAUNDER'S TREASURY of **GEOGRAPHY**, Physical, Historical, Descriptive, and Political. Edited by W. HUGHES, F.R.G.S. With 7 Maps and 16 Plates. Fcp. 10s.

Natural History and Popular Science.

The **ELEMENTS** of **PHYSICS** or **NATURAL PHILOSOPHY**. By NEIL ARNOTT, M.D. F.R.S. Physician Extraordinary to the Queen. Sixth Edition. PART I. 8vo. 10s. 6d.

HEAT CONSIDERED as a **MODE** of **MOTION**. By Professor JOHN TYNDALL, LL.D. F.R.S. Second Edition. Crown 8vo. with Woodcuts, 12s. 6d.

A TREATISE ON MINERALOGY, in THEORY and PRACTICE. By A. DE LA RIVE, Prof. in the Academy of Geneva. Translated by C. V. WALKER, F.R.S. 3 vols. 8vo. with Woodcuts, £3 13s.

The CORRELATION of PHYSICAL FORCES. By W. R. GROVE, Q.C. V.P.R.S. Fourth Edition. 8vo. 7s. 6d.

The GEOLOGICAL MAGAZINE; or, Monthly Journal of Geology. Edited by HENRY WOODWARD, F.G.S. F.Z.S. British Museum: assisted by Professor J. MORRIS, F.G.S. and R. ETHERIDGE, F.R.S.E. F.G.S. 8vo. price 1s. monthly.

A GUIDE to GEOLOGY. By J. PHILLIPS, M.A. Professor of Geology in the University of Oxford. Fifth Edition; with Plates and Diagrams. Fcp. 4s.

A GLOSSARY of MINERALOGY. By H. W. BRISTOW, F.G.S. of the Geological Survey of Great Britain. With 486 Figures. Crown 8vo. 12s.

PHILLIPS'S ELEMENTARY INTRODUCTION to MINERALOGY, with extensive Alterations and Additions, by H. J. BROOKE, F.R.S. and W. H. MILLER, F.G.S. Post 8vo. with Woodcuts, 18s.

VAN DER HOEVEN'S HANDBOOK of ZOOLOGY. Translated from the Second Dutch Edition by the Rev. W. CLARK, M.D. F.R.S. 2 vols. 8vo. with 24 Plates of Figures, 60s.

The COMPARATIVE ANATOMY and PHYSIOLOGY of the VERTEBRATE Animals. By RICHARD OWEN, F.R.S. D.C.L. 2 vols. 8vo. with upwards of 1,200 Woodcuts. *[In the press.]*

HOMES WITHOUT HANDS: an Account of the Habitations constructed by various Animals, classed according to their Principles of Construction. By Rev. J. G. WOOD, M.A. F.L.S. Illustrations on Wood by G. Pearson, from Drawings by F. W. Keyl and E. A. Smith. In 20 Parts, 1s. each.

MANUAL of CORALS and SEA JELLIES. By J. R. GREENE, B.A. Edited by the Rev. J. A. GALBRAITH, M.A. and the Rev. S. HAUGHTON, M.D. Fcp. with 39 Woodcuts, 5s.

Manual of Sponges and Animalculæ; with a General Introduction on the Principles of Zoology. By the same Author and Editors. Fcp. with 16 Woodcuts, 2s.

Manual of the Metalloids. By J. APJOHN, M.D. F.R.S. and the same Editors. Fcp. with 38 Woodcuts, 7s. 6d.

The SEA and its LIVING WONDERS. By Dr. G. HARTWIG. Second (English) Edition. 8vo. with many Illustrations. 18s.

The TROPICAL WORLD. By the same Author. With 8 Chromoxylographs and 172 Woodcuts. 8vo. 21s.

SKETCHES of the NATURAL HISTORY of CEYLON. By Sir J. EMERSON TENNENT, K.C.S. LL.D. With 82 Wood Engravings. Post 8vo. price 12s. 6d.

Ceylon. By the same Author. Fifth Edition; with Maps, &c. and 90 Wood Engravings. 2 vols. 8vo. £2 10s

- ...S and MYSTERIES of INSTINCT;** By E. ...
 Norwich. Seventh Edition, 1
- Life.** By G. GARRATT. Third Edition. Fcp. 7
- HOME WALKS and HOLIDAY RAMBLES.**
 JOHNS, B.A. F.L.S. Fcp. 8vo. with 10 Illustrations.
 price 5s.
- KIRBY and SPENCE'S INTRODUCTION**
 Elements of the Natural History of Insects. Sec
 price 5s.
- MAUNDER'S TREASURY of NATURAL**
 Dictionary of Zoology. Revised and corrected
 Fcp. with 900 Woodcuts, 10s.
- The TREASURY of BOTANY,** on the Plan
 By J. LINDLEY, M.D. and T. MOORE, F.L.S.
 Botanists. With 16 Plates, and many Woodcuts.
 Fitch. Fcp.
- The ROSE AMATEUR'S GUIDE.** By THOMAS
 Fcp. 4s.
- The BRITISH FLORA;** comprising the Phae
 Plants and the Ferns. By Sir W. J. HOOKER
 ARNOTT, LL.D. 12mo. with 12 Plates, 14s. or col
 and Ireland, arranged and described. By W. W
 42s. or coloured, 24 4s.
- The INDOOR GARDENER.** By Miss MALDEN
 piece, printed in Colours, 5s.
- LOUDON'S ENCYCLOPEDIA of PLANTS;**
 Character, Description, Culture, History, &c.
 Great Britain. With upwards of 12,000 Woodcuts
 London's Encyclopædia of Trees and Shrubs
 Trees and Shrubs of Great Britain scientific
 With 2,000 Woodcuts. 8vo. 50s.
- MAUNDER'S SCIENTIFIC and LITERARY**
 Encyclopædia of Science, Literature, and Art.
- A DICTIONARY of SCIENCE, LITERATURE**
 Edition. Edited by W. T. BRANDE, D.C.L. and
 assisted by gentlemen of eminent Scientific a
 In 12 Parts, each containing 240 pages, price 5s.
 price 21s. each.
- ESSAYS on SCIENTIFIC and other SUBJECTS**
 Reviews. By Sir H. HOLLAND, Bart. M.D. Sec
- ESSAYS from the EDINBURGH and QUARTERLY**
 with Addresses and other Pieces. By Sir J. F.
 8vo. 18s.



- A DICTIONARY of CHEMISTRY** and the Allied Branches of other Sciences; founded on that of the late Dr. Ure. By HENRY WATTS, F.C.S. assisted by eminent Contributors. 5 vols. medium 8vo. in course of publication in Parts. VOL. I. 31s. 6d. VOL. II. 26s. VOL. III. 31s. 6d. are now ready.
- HANDBOOK of CHEMICAL ANALYSIS.** Adapted to the Unitary System of Notation. By F. T. CONINGTON, M.A. F.C.S. Post 8vo. 7s. 6d.—**TABLES of QUALITATIVE ANALYSIS** adapted to the same, 2s. 6d.
- A HANDBOOK of VOLUMETRICAL ANALYSIS.** By ROBERT H. SCOTT, M.A. T.C.D. Post 8vo. 4s. 6d.
- ELEMENTS of CHEMISTRY, Theoretical and Practical.** By WILLIAM A. MILLER, M.D. LL.D. F.R.S. F.G.S. Professor of Chemistry, King's College, London. 3 vols. 8vo. £2 13s. PART I. CHEMICAL PHYSICS. Third Edition, 12s. PART II. INORGANIC CHEMISTRY, 21s. PART III. ORGANIC CHEMISTRY, Second Edition, 20s.
- A MANUAL of CHEMISTRY, Descriptive and Theoretical.** By WILLIAM ODLING, M.B. F.R.S. Lecturer on Chemistry at St. Bartholomew's Hospital. PART I. 8vo. 9s.
- A Course of Practical Chemistry, for the use of Medical Students.** By the same Author. Second Edition, with 70 new Woodcuts. Crown 8vo. price 7s. 6d.
- The DIAGNOSIS and TREATMENT of the DISEASES of WOMEN;** including the Diagnosis of Pregnancy. By GRAILY HEWITT, M.D. Physician to the British Lying-in Hospital. 8vo. 16s.
- LECTURES on the DISEASES of INFANCY and CHILDHOOD.** By CHARLES WEST, M.D. &c. Fifth Edition, revised and enlarged. 8vo. 16s.
- EXPOSITION of the SIGNS and SYMPTOMS of PREGNANCY:** with other Papers on subjects connected with Midwifery. By W. F. MONTGOMERY, M.A. M.D. M.R.I.A. 8vo. with Illustrations, 25s.
- A SYSTEM of SURGERY, Theoretical and Practical.** In Treatises by Various Authors. Edited by T. HOLMES, M.A. Cantab. Assistant-Surgeon to St. George's Hospital. 4 vols. 8vo. £4 13s.
- Vol. I. General Pathology.** 21s.
- Vol. II. Local Injuries: Gunshot Wounds, Injuries of the Head, Back, Face, Neck, Chest, Abdomen, Pelvis, of the Upper and Lower Extremities, and Diseases of the Eye.** 21s.
- Vol. III. Operative Surgery. Diseases of the Organs of Circulation, Locomotion, &c.** 21s.
- Vol. IV. Diseases of the Organs of Digestion, of the Genito-Urinary System, and of the Breast, Thyroid Gland, and Skin; with APPENDIX and GENERAL INDEX.** 30s.
- LECTURES on the PRINCIPLES and PRACTICE of PHYSIC.** By THOMAS WATSON, M.D. Physician-Extraordinary to the Queen. Fourth Edition. 2 vols. 8vo. 34s.

- LECTURES on SURGICAL PATHOLOGY.** By J. PAGET, F.R.S. Surgeon-Extraordinary to the Queen. Edited by W. TURNER, M.B. 8vo. with 117 Woodcuts, 81s.
- A TREATISE on the CONTINUED FEVERS of GREAT BRITAIN.** By C. MURCHISON, M.D. Senior Physician to the London Fever Hospital. 8vo. with coloured Plates, 18s.
- ANATOMY, DESCRIPTIVE and SURGICAL.** By HENRY GRAY, F.R.S. With 410 Wood Engravings from Dissections. Third Edition, by T. HOLMES, M.A. Cantab. Royal 8vo. 28s.
- The CYCLOPÆDIA of ANATOMY and PHYSIOLOGY.** Edited by the late R. B. TODD, M.D. F.R.S. Assisted by nearly all the most eminent cultivators of Physiological Science of the present age. 5 vols. 8vo. with 2,853 Woodcuts, £6 6s.
- PHYSIOLOGICAL ANATOMY and PHYSIOLOGY of MAN.** By the late R. B. TODD, M.D. F.R.S. and W. BOWMAN, F.R.S. of King's College. With numerous Illustrations. VOL. II. 8vo. 25s.
- A DICTIONARY of PRACTICAL MEDICINE.** By J. COPLAND, M.D. F.R.S. Abridged from the larger work by the Author, assisted by J. C. COPLAND, M.R.C.S. 1 vol. 8vo. [In the press.]
- Dr. Copland's Dictionary of Practical Medicine (the larger work).** 3 vols. 8vo. £5 11s.
- The WORKS of SIR B. C. BRODIE, Bart.** collected and arranged by CHARLES HAWKINS, F.R.C.S.E. 3 vols. 8vo. with Medallion and Facsimile, 48s.
- Autobiography of Sir B. C. Brodie, Bart.** Printed from the Author's materials left in MS. Fcp. 4s. 6d.
- MEDICAL NOTES and REFLECTIONS.** By Sir H. HOLLAND, Bart. M.D. Third Edition. 8vo. 18s.
- A MANUAL of MATERIA MEDICA and THERAPEUTICS,** abridged from Dr. PERRIRA's *Elements* by F. J. FARRE, M.D. Cantab. assisted by R. BENTLEY, M.R.C.S. and by R. WARINGTON, F.C.S. 1 vol. 8vo. [In October.]
- Dr. Pereira's Elements of Materia Medica and Therapeutics.** Third Edition. By A. S. TAYLOR, M.D. and G. O. REES, M.D. 3 vols. 8vo. with Woodcuts, £3 15s.
- THOMSON'S CONSPECTUS of the BRITISH PHARMACOPEIA.** Twenty-fourth Edition, corrected and made conformable throughout to the New Pharmacopœia of the General Council of Medical Education. By E. LLOYD BIRKETT, M.D. 18mo. 5s. 6d.
- MANUAL of the DOMESTIC PRACTICE of MEDICINE.** By W. B. KESTVEN, F.R.C.S.E. Second Edition, thoroughly revised, with Additions. Fcp. 5s.

The Fine Arts, and Illustrated Editions.

- The NEW TESTAMENT,** illustrated with Wood Engravings after the Early Masters, chiefly of the Italian School. Crown 4to. 63s. cloth, gilt top; or £5 5s. elegantly bound in morocco.

LYRA GERMANICA; Hymns for the Sundays and Chief Festivals of the Christian Year. Translated by CATHERINE WINKWORTH; 125 Illustrations on Wood drawn by J. LEIGHTON, F.S.A. Fcp. 4to. 21s.

CATS' and FARLIE'S MORAL EMBLEMS; with Aphorisms, Adages, and Proverbs of all Nations: comprising 121 Illustrations on Wood by J. LEIGHTON, F.S.A. with an appropriate Text by R. PIGOT. Imperial 8vo. 31s. 6d.

BUNYAN'S PILGRIM'S PROGRESS: with 126 Illustrations on Steel and Wood by C. BENNETT; and a Preface by the Rev. C. KINGSLEY. Fcp. 4to. 21s.

SHAKSPEARE'S SENTIMENTS and SIMILES, printed in Black and Gold, and Illuminated in the Missal Style by HENRY NOEL HUMPHREYS. In massive covers, containing the Medallion and Cypher of Shakspeare. Square post 8vo. 21s.

The **HISTORY of OUR LORD**, as exemplified in Works of Art: with that of His Types in the Old and New Testament. By Mrs. JAMESON and Lady EASTLAKE. Being the concluding SERIES of 'Sacred and Legendary Art;' with 13 Etchings and 281 Woodcuts. 2 vols. square crown 8vo. 42s.

In the same Series, by Mrs. JAMESON.

Legends of the Saints and Martyrs. Fourth Edition, with 19 Etchings and 187 Woodcuts. 2 vols. 31s. 6d.

Legends of the Monastic Orders. Third Edition, with 11 Etchings and 88 Woodcuts. 1 vol. 21s.

Legends of the Madonna. Third Edition, with 27 Etchings and 165 Woodcuts. 1 vol. 21s.

Arts, Manufactures, &c.

ENCYCLOPÆDIA of ARCHITECTURE, Historical, Theoretical, and Practical. By JOSEPH GWILT. With more than 1,000 Woodcuts. 8vo. 42s.

TUSCAN SCULPTORS, their Lives, Works, and Times. With 45 Etchings and 28 Woodcuts from Original Drawings and Photographs. By CHARLES C. PERKINS. 2 vols. imperial 8vo. 63s.

The **ENGINEER'S HANDBOOK**; explaining the Principles which should guide the young Engineer in the Construction of Machinery. By C. S. LOWNDES. Post 8vo. 5s.

The **ELEMENTS of MECHANISM**. By T. M. GOODEVE, M.A. Professor of Mechanics at the E. M. Acad. Woolwich. Second Edition, with 217 Woodcuts. Post 8vo. 6s. 6d.

URRE'S DICTIONARY of ARTS, MANUFACTURES, and MINES. Re-written and enlarged by ROBERT HUNT, F.R.S. assisted by numerous gentlemen eminent in Science and the Arts. With 2,000 Woodcuts. 3 vols. 8vo. 24.

ENCYCLOPÆDIA of CIVIL ENGINEERING, Historical, Theoretical, and Practical. By E. CRENSY, C.E. With above 3,000 Woodcuts. 8vo. 42s.

TREATISE on MILLS and MILLWORK. By W. FAIRBAIRN, C.E. F.R.S. With 18 Plates and 322 Woodcuts. 2 vols. 8vo. 32s.

Useful Information for Engineers. By the same Author. **FIRST and SECOND SERIES**, with many Plates and Woodcuts. 2 vols. crown 8vo. 10s. 6d. each.

The Application of Cast and Wrought Iron to Building Purposes. By the same Author. Third Edition, with 6 Plates and 118 Woodcuts. 8vo. 16s.

The PRACTICAL MECHANIC'S JOURNAL: an Illustrated Record of Mechanical and Engineering Science, and Epitome of Patent Inventions 4to. price 1s. monthly.

The PRACTICAL DRAUGHTSMAN'S BOOK of INDUSTRIAL DESIGN. By W. JOHNSON, Assoc. Inst. C.E. With many hundred Illustrations 4to. 2s. 6d.

The PATENTEE'S MANUAL: a Treatise on the Law and Practice of Letters Patent for the use of Patentees and Inventors. By J. and J. H. JOHNSON. Post 8vo. 7s. 6d.

The ARTISAN CLUB'S TREATISE on the STEAM ENGINE, in its various Applications to Mines, Mills, Steam Navigation, Railways and Agriculture. By J. BOURNE, C.E. Sixth Edition; with 37 Plates and 546 Woodcuts. 4to. 42s.

Catechism of the Steam Engine, in its various Applications to Mines, Mills, Steam Navigation, Railways, and Agriculture. By the same Author. With 199 Woodcuts. Fcp. 9s. The INTRODUCTION of 'Recent Improvements' may be had separately, with 110 Woodcuts, price 3s. 6d.

Handbook of the Steam Engine. By the same Author, forming a KEY to the Catechism of the Steam Engine, with 67 Woodcuts. Fcp. 9s.

The THEORY of WAR Illustrated by numerous Examples from History. By Lieut.-Col. P. L. MACDOUGALL. Third Edition, with 10 Plans. Post 8vo. 10s. 6d.

COLLIERIES and COLLIERIES; A Handbook of the Law and leading Cases relating thereto. By J. C. FOWLER, Barrister-at-Law, Stipendiary Magistrate. Fcp. 6s.

The ART of PERFUMERY; the History and Theory of Odours, and the Methods of Extracting the Aromas of Plants. By Dr. PISSSE, F.C.S. Third Edition, with 53 Woodcuts. Crown 8vo. 10s. 6d.

Chemical, Natural, and Physical Magic, for Juveniles during the Holidays. By the same Author. Third Edition, enlarged, with 38 Woodcuts. Fcp. 6s.

The Laboratory of Chemical Wonders: a Scientific Mélange for Young People. By the same. Crown 8vo. 5s. 6d.

TALPA; or the Chronicles of a Clay Farm. By C. W. HOSKYNs, Esq. With 24 Woodcuts from Designs by G. CRUIKSHANK. 16mo. 5s. 6d.

H.B.H the PRINCE CONSORT'S FARMS: an Agricultural Memoir. By JOHN CHALMERS MORTON. Dedicated by permission to Her Majesty the QUEEN. With 40 Wood Engravings. 4to. 52s. 6d.

- LOUDON'S ENCYCLOPEDIA of AGRICULTURE:** comprising the Laying-out, Improvement, and Management of Landed Property, and the Cultivation and Economy of the Productions of Agriculture. With 1,100 Woodcuts. 8vo. 31s. 6d.
- Loudon's Encyclopædia of Gardening:** comprising the Theory and Practice of Horticulture, Floriculture, Arboriculture, and Landscape Gardening. With 1,000 Woodcuts. 8vo. 31s. 6d.
- Loudon's Encyclopædia of Cottage, Farm, and Villa Architecture and Furniture.** With more than 2,000 Woodcuts. 8vo. 42s.
- HISTORY of WINDSOR GREAT PARK and WINDSOR FOREST.** By WILLIAM MENZIES, Resident Deputy Surveyor. With 2 Maps and 20 Photographs. Imp. folio, £38s.
- The Sanitary Management and Utilisation of Sewage:** comprising Details of a System applicable to Cottages, Dwelling-Houses, Public Buildings, and Towns; Suggestions relating to the Arterial Drainage of the Country, and the Water Supply of Rivers. By the same Author. Imp. 8vo. with 9 Illustrations, 12s. 6d.
- BAYLDON'S ART of VALUING RENTS and TILLAGES, and Claims of Tenants upon Quitting Farms, both at Michaelmas and Lady-Day.** Eighth Edition, revised by J. C. MORTON. 8vo. 10s. 6d.

Religious and Moral Works.

- An EXPOSITION of the 39 ARTICLES, Historical and Doctrinal.** By E. HAROLD BROWNE, D.D. Lord Bishop of Ely. Sixth Edition, 8vo. 16s.
- The Pentateuch and the Elohistic Psalms, in Reply to Bishop Colenso.** By the same. Second Edition. 8vo. 2s.
- Examination Questions on Bishop Browne's Exposition of the Articles.** By the Rev. J. GORLE, M.A. Fop. 8s. 6d.
- FIVE LECTURES on the CHARACTER of ST. PAUL;** being the Hulsean Lectures for 1862. By the Rev. J. S. HOWSON, D.D. Second Edition. 8vo. 9s.
- The LIFE and EPISTLES of ST. PAUL.** By W. J. CONYBEARE, M.A. late Fellow of Trin. Coll. Cantab. and J. S. HOWSON, D.D. Principal of Liverpool Coll.
- LIBRARY EDITION,** with all the Original Illustrations, Maps, Landscapes on Steel, Woodcuts, &c. 2 vols. 4to. 48s.
- INTERMEDIATE EDITION,** with a Selection of Maps, Plates, and Woodcuts. 2 vols. square crown 8vo. 31s. 6d.
- PEOPLE'S EDITION,** revised and condensed, with 46 Illustrations and Maps. 2 vols. crown 8vo. 12s.
- The VOYAGE and SHIPWRECK of ST. PAUL;** with Dissertations on the Ships and Navigation of the Ancients. By JAMES SMITH, F.R.S. Crown 8vo. Charts, 8s. 6d.

- A CRITICAL and GRAMMATICAL COMMENTARY on ST. PAUL'S Epistles.** By C. J. ELLICOTT, D.D. Lord Bishop of Gloucester and Bristol. 8vo Galatians, Third Edition, 8s. 6d.
- Ephesians**, Third Edition, 8s. 6d.
- Pastoral Epistles**, Third Edition, 10s. 6d.
- Philippians, Colossians, and Philemon**, Third Edition, 10s. 6d.
- Thessalonians**, Second Edition, 7s. 6d.
- Historical Lectures on the Life of our Lord Jesus Christ: being the Hulsean Lectures for 1859.** By the same Author. Fourth Edition. 8vo. price 10s. 6d.
- The Destiny of the Creature; and other Sermons preached before the University of Cambridge.** By the same. Post 8vo. 5s.
- The Broad and the Narrow Way; Two Sermons preached before the University of Cambridge.** By the same. Crown 8vo. 2s.
- Rev. T. H. HORNE'S INTRODUCTION to the CRITICAL STUDY and Knowledge of the Holy Scriptures.** Eleventh Edition, corrected and extended under careful Editorial revision. With 4 Maps and 22 Woodcuts and Facsimiles. 4 vols. 8vo. £3 13s. 6d.
- Rev. T. H. Horne's Compendious Introduction to the Study of the Bible, being an Analysis of the larger work by the same Author.** Re-edited by the Rev. JOHN AYRE, M.A. With Maps, &c. Post 8vo. 9s.
- The TREASURY of BIBLE KNOWLEDGE, on the Plan of Maunder's Treasuries.** By the Rev. JOHN AYRE, M.A. Fcp. 8vo. with Maps and Illustrations. [*In the press.*]
- The GREEK TESTAMENT; with Notes, Grammatical and Exegetical.** By the Rev. W. WEBSTER, M.A. and the Rev. W. F. WILKINSON, M.A. 2 vols. 8vo. £2 4s.
- VOL. I. the Gospels and Acts, 20s.
- VOL. II. the Epistles and Apocalypse, 24s.
- The FOUR EXPERIMENTS in Church and State; and the Conflicts of Churches.** By Lord ROBERT MONTAGU, M.P. 8vo. 12s.
- EVERY-DAY SCRIPTURE DIFFICULTIES explained and illustrated; Gospels of St. Matthew and St. Mark.** By J. E. PRESCOTT, M.A. 8vo. 9s.
- The PENTATEUCH and BOOK of JOSHUA CRITICALLY EXAMINED.** By the Right Rev. J. W. COLENZO, D.D. Lord Bishop of Natal. People's Edition, in 1 vol. crown 8vo. 6s. or in 5 Parts, 1s. each.
- The PENTATEUCH and BOOK of JOSHUA CRITICALLY EXAMINED.** By Prof. A. KUENEN, of Leyden. Translated from the Dutch, and edited with Notes, by the Right Rev. J. W. COLENZO, D.D. Bishop of Natal. 8vo. 8s. 6d.
- The FORMATION of CHRISTENDOM. PART I.** By T. W. ALLIES. 8vo. 12s.

- CHRISTENDOM'S DIVISIONS:** a Philosophical Sketch of the Divisions of the Christian Family in East and West. By EDMUND S. FFOULKES, formerly Fellow and Tutor of Jesus Coll. Oxford. Post 8vo. 7s. 6d.
- The LIFE of CHRIST:** an Eclectic Gospel, from the Old and New Testaments, arranged on a New Principle, with Analytical Tables, &c. By CHARLES DE LA PRYME, M.A. Trin. Coll. Camb. Revised Edition, 8vo. 5s.
- The HIDDEN WISDOM of CHRIST and the KEY of KNOWLEDGE;** or, History of the Apocrypha. By ERNEST DE BUNSEN. 2 vols. 8vo. 28s.
- HIPPOLYTUS and his AGE;** or, the Beginnings and Prospects of Christianity. By Baron BUNSEN, D.D. 2 vols. 8vo. 80s.
- Outlines of the Philosophy of Universal History,** applied to Language and Religion: Containing an Account of the Alphabetical Conferences. By the same Author. 2 vols. 8vo. 33s.
- Analecta Ante-Nicæna.** By the same Author. 3 vols. 8vo. 42s.
- ESSAYS on RELIGION and LITERATURE.** By various Writers. Edited by H. E. MANNING, D.D. 8vo. 10s. 6d.
- ESSAYS and REVIEWS.** By the Rev. W. TEMPLE, D.D. the Rev. R. WILLIAMS, B.D. the Rev. B. POWELL, M.A. the Rev. H. B. WILSON, B.D. C. W. GOODWIN, M.A. the Rev. M. PATTISON, B.D. and the Rev. B. JOWETT, M.A. Twelfth Edition. Fcp. 8vo. 5s.
- MOSHEIM'S ECCLESIASTICAL HISTORY.** MURDOCK and SOAMES'S Translation and Notes, re-edited by the Rev. W. STURBS, M.A. 3 vols. 8vo. 45s.
- BISHOP JEREMY TAYLOR'S ENTIRE WORKS:** With Life by BISHOP HEBER. Revised and corrected by the Rev. C. P. EDEN, 10 vols. price £5 5s.
- PASSING THOUGHTS on RELIGION.** By the Author of 'Amy Herbert.' Eighth Edition. Fcp. 8vo. 5s.
- Thoughts for the Holy Week,** for Young Persons. By the same Author. Third Edition. Fcp. 8vo. 2s.
- Night Lessons from Scripture.** By the same Author. Second Edition, 32mo. 3s.
- Self-Examination before Confirmation.** By the same Author. 32mo. price 1s. 6d.
- Readings for a Month Preparatory to Confirmation,** from Writers of the Early and English Church. By the same. Fcp. 4s.
- Readings for Every Day in Lent,** compiled from the Writings of Bishop JEREMY TAYLOR. By the same. Fcp. 5s.
- Preparation for the Holy Communion;** the Devotions chiefly from the works of JEREMY TAYLOR. By the same. 32mo. 3s.
- MORNING CLOUDS.** Second Edition. Fcp. 5s.
- Spring and Autumn.** By the same Author. Post 8vo. 6s.

The WIFE'S MANUAL; or, Prayers, Thoughts, and Songs on Several Occasions of a Matron's Life. By the Rev. W. CALVERT, M.A. Crown 8vo. price 10s. 6d.

SPIRITUAL SONGS for the **SUNDAYS** and **HOLIDAYS** throughout the Year. By J. S. B. MONSELL, LL.D. Vicar of Egham. Fourth Edition. Fcp. 4s. 6d.

The Beatitudes: Abasement before God; Sorrow for Sin; Meekness of Spirit; Desire for Holiness; Gentleness; Purity of Heart; the Peacemakers; Sufferings for Christ. By the same. Second Edition, fcp. 3s. 6d.

HYMNOLOGIA CHRISTIANA; or, Psalms and Hymns selected and arranged in the order of the Christian Seasons. By B. H. KENNEDY, D.D. Prebendary of Lichfield. Crown 8vo. 7s. 6d.

LYRA DOMESTICA; Christian Songs for Domestic Edification. Translated from the *Psalter and Harp* of C. J. P. SPITTA, and from other sources, by RICHARD MASSIE. FIRST and SECOND SERIES, fcp. 4s. 6d. each.

LYRA SACRA; Hymns, Ancient and Modern, Odes and Fragments of Sacred Poetry. Edited by the Rev. B. W. SAVILE, M.A. Fcp. 5s.

LYRA GERMANICA, translated from the German by Miss C. WINKWORTH. FIRST SERIES, Hymns for the Sundays and Chief Festivals; SECOND SERIES, the Christian Life. Fcp. 5s. each SERIES.

Hymns from *Lyra Germanica*, 18mo. 1s.

HISTORICAL NOTES to the '**LYRA GERMANICA**:' containing brief Memoirs of the Authors of the Hymns, and Notices of Remarkable Occasions on which some of them have been used; with Notices of other German Hymn Writers. By THEODORE KÜBLER. Fcp. 7s. 6d.

LYRA EUCHARISTICA; Hymns and Verses on the Holy Communion, Ancient and Modern: with other Poems. Edited by the Rev. ORBY SHIPLEY, M.A. Second Edition. Fcp. 7s. 6d.

Lyra Messianica; Hymns and Verses on the Life of Christ, Ancient and Modern; with other Poems. By the same Editor. Fcp. 7s. 6d.

Lyra Mystica; Hymns and Verses on Sacred Subjects, Ancient and Modern. By the same Editor. Fcp. 7s. 6d.

The CHORALE BOOK for **ENGLAND**; a complete Hymn-Book in accordance with the Services and Festivals of the Church of England: the Hymns translated by Miss C. WINKWORTH; the tunes arranged by Prof. W. S. BENNETT and OTTO GOLDSCHMIDT. Fcp. 4to. 12s. 6d.

Congregational Edition. Fcp. 2s.

The CATHOLIC DOCTRINE of the **ATONEMENT**: an Historical Inquiry into its Development in the Church; with an Introduction on the Principle of Theological Developments. By H. N. OXENHAM, M.A. formerly Scholar of Balliol College, Oxford. 8vo. 8s. 6d.

FROM SUNDAY TO SUNDAY: an attempt to consider familiarly the Weekday Life and Labours of a Country Clergyman. By R. GEE, M.A. Vicar of Abbott's Langley and Rural Dean. Fcp. 5s.

FIRST SUNDAYS at **CHURCH**; or, Familiar Conversations on the Morning and Evening Services of the Church of England. By J. E. RIDDLE, M.A. Fcp. 2s. 6d.

The **JUDGMENT of CONSCIENCE**, and other Sermons. By **RICHARD WHATELY**, D.D. late Archbishop of Dublin. Crown 8vo. 4s. 6d.

PALEY'S MORAL PHILOSOPHY, with Annotations. By **RICHARD WHATELY**, D.D. late Archbishop of Dublin. 8vo. 7s.

Travels, Voyages, &c.

OUTLINE SKETCHES of the HIGH ALPS of DAUPHINÉ. By **T. G. BONNEY**, M.A. F.G.S. M.A.C. Fellow of St. John's Coll. Camb. With 13 Plates and a Coloured Map. Post 4to. 16s.

ICE-CAVES of FRANCE and SWITZERLAND; a Narrative of Subterranean Exploration. By the Rev. **G. F. BROWNE**, M.A. Fellow and Assistant-Tutor of St. Catherine's Coll. Cambridge, M.A.C. With 11 Illustrations on Wood. Square crown 8vo. 12s. 6d.

VILLAGE LIFE in SWITZERLAND. By **SOPHIA D. DELMARD**. Post 8vo. 9s. 6d.

HOW WE SPENT the SUMMER; or, a Voyage en Zigzag in Switzerland and Tyrol with some Members of the **ALPINE CLUB**. From the Sketch-Book of one of the Party. In oblong 4to. with about 300 Illustrations, 10s. 6d.

MAP of the CHAIN of MONT BLANC, from an actual Survey in 1863—1864. By **A. ADAMS-REILLY**, F.R.G.S. M.A.C. Published under the Authority of the Alpine Club. In Chromolithography on extra stout drawing-paper 28in. x 17in. price 10s. or mounted on canvas in a folding case, 12s. 6d.

The **HUNTING-GROUNDS of the OLD WORLD. FIRST SERIES. Asia**. By **H. A. L. the Old Shekarry**. Third Edition, with 7 Illustrations, 8vo. 18s.

CAMP and CANTONMENT; a Journal of Life in India in 1857—1859, with some Account of the Way thither. By **Mrs. LEOPOLD PAGET**. To which is added a Short Narrative of the Pursuit of the Rebels in Central India by Major **PAGET**, R.H.A. Post 8vo. 10s. 6d.

EXPLORATIONS in SOUTH-WEST AFRICA, from Walvisch Bay to Lake Ngami and the Victoria Falls. By **THOMAS BAINES**, F.R.G.S. 8vo. with Map and Illustrations, 21s.

SOUTH AMERICAN SKETCHES; or, a Visit to Rio Janeiro, the Organ Mountains, La Plata, and the Paraná. By **THOMAS W. HIESCHLIFF**, M.A. F.R.G.S. Post 8vo. with Illustrations, 12s. 6d.

VANCOUVER ISLAND and BRITISH COLUMBIA; their History, Resources, and Prospects. By **MATTHEW MACYER**, F.R.G.S. With Maps and Illustrations. 8vo. 18s.

HISTORY of DISCOVERY in our AUSTRALASIAN COLONIES, Australia, Tasmania, and New Zealand, from the Earliest Date to the Present Day. By **WILLIAM HOWITT**. With 3 Maps of the Recent Explorations from Official Sources. 2 vols. 8vo. 28s.

- THE CAPITAL of the TYCOON**; a Narrative of a Three Years' Residence in Japan. By Sir RUTHERFORD ALCOCK, K.C.B. 2 vols. 8vo. with numerous Illustrations, 42s.
- LAST WINTER in ROME.** By C. R. WELD. With Portrait and Engravings on Wood. Post 8vo. 14s.
- AUTUMN RAMBLES in NORTH AFRICA.** By JOHN ORMSBY, of the Middle Temple. With 16 Illustrations. Post 8vo. 8s. 6d.
- The DOLOMITE MOUNTAINS.** Excursions through Tyrol, Carinthia, Carniola, and Friuli in 1861, 1862, and 1863. By J. GILBERT and G. C. CHURCHILL, F.R.G.S. With numerous Illustrations. Square crown 8vo. 21s.
- A SUMMER TOUR in the GEISONS and ITALIAN VALLEYS** of the Bernina. By Mrs. HENRY FRESHFIELD. With 2 Coloured Maps and 4 Views. Post 8vo. 10s. 6d.
- Alpine Byeways**; or, Light Leaves gathered in 1859 and 1860. By the same Authoress. Post 8vo. with Illustrations, 10s. 6d.
- A LADY'S TOUR ROUND MONTE ROSA**; including Visits to the Italian Valleys. With Map and Illustrations. Post 8vo. 14s.
- GUIDE to the PYRENEES**, for the use of Mountaineers. By CHARLES PACKE. With Maps, &c. and Appendix. Fcp. 6s.
- The ALPINE GUIDE.** By JOHN BALL, M.R.I.A. late President of the Alpine Club. Post 8vo. with Maps and other Illustrations.
- Guide to the Western Alps**, including Mont Blanc, Monte Rosa, Zermatt, &c. 7s. 6d.
- Guide to the Oberland and all Switzerland**, excepting the Neighbourhood of Monte Rosa and the Great St. Bernard; with Lombardy and the adjoining portion of Tyrol. 7s. 6d.
- CHRISTOPHER COLUMBUS**; his Life, Voyages, and Discoveries. Revised Edition, with 4 Woodcuts. 18mo. 2s. 6d.
- CAPTAIN JAMES COOK**; his Life, Voyages, and Discoveries. Revised Edition, with numerous Woodcuts. 18mo. 2s. 6d.
- NARRATIVES of SHIPWRECKS of the ROYAL NAVY** between 1793 and 1857, compiled from Official Documents in the Admiralty by W. O. S. GILLY; with a Preface by W. S. GILLY, D.D. Third Edition, fcp. 5s.
- A WEEK at the LAND'S END.** By J. T. BLIGHT; assisted by E. H. RODD, R. Q. COUCH, and J. RALPH. With Map and 96 Woodcuts. Fcp. price 6s. 6d.
- VISITS to REMARKABLE PLACES**: Old Halls, Battle-Fields, and Scenes Illustrative of Striking Passages in English History and Poetry. By WILLIAM HOWITT. 2 vols. square crown 8vo. with Wood Engravings, price 25s.
- The RURAL LIFE of ENGLAND.** By the same Author. With Woodcuts by Bewick and Williams. Medium 8vo. 12s. 6d.

Works of Fiction.

- LATE LAURELS**: a Tale. By the Author of 'Wheat and Tares' 2 vols. post 8vo. 15s.
- A FIRST FRIENDSHIP.** [Reprinted from *Fraser's Magazine.*] Crown 8vo. 7s. 6d.
- ATHERSTONE PRIORY.** By L. N. COMYN. 2 vols. post 8vo. 21s.
- Ellice**: a Tale. By the same. Post 8vo. 9s. 6d.
- STORIES and TALES** by the Author of 'Amy Herbert,' uniform Edition, each Tale or Story complete in a single Volume.
- | | |
|-----------------------------|---------------------------|
| AMY HERBERT, 2s. 6d. | IVORS, 3s. 6d. |
| GERTRUDE, 2s. 6d. | KATHARINE ASHTON, 3s. 6d. |
| EARL'S DAUGHTER, 2s. 6d. | MARGARET PERCIVAL, 5s. |
| EXPERIENCE OF LIFE, 2s. 6d. | LANTON PARSONAGE, 4s. 6d. |
| CLEVE HALL, 3s. 6d. | URSULA, 4s. 6d. |
- A Glimpse of the World.** By the Author of 'Amy Herbert.' Fcp. 7s. 6d.
- ESSAYS on FICTION**; reprinted chiefly from Reviews, with Additions. By NASSAU W. SENIOR. Post 8vo. 10s. 6d.
- ELIHU JAN'S STORY**; or, the Private Life of an Eastern Queen. By WILLIAM KNIGHTON, LL.D. Assistant-Commissioner in Oudh. Post 8vo. 7s. 6d.
- THE SIX SISTERS of the VALLEYS**: an Historical Romance. By W. BRAMLEY-MOORE, M.A. Incumbent of Gerrard's Cross, Bucks. Third Edition, with 14 Illustrations. Crown 8vo. 5s.
- The GLADIATORS**: A Tale of Rome and Judæa. By G. J. WHYTE MELVILLE. Crown 8vo. 5s.
- Digby Grand**, an Autobiography. By the same Author. 1 vol. 5s.
- Kate Coventry**, an Autobiography. By the same. 1 vol. 5s.
- General Bounce**, or the Lady and the Locusts. By the same. 1 vol. 5s.
- Holmby House**, a Tale of Old Northamptonshire. 1 vol. 5s.
- Good for Nothing**, or All Down Hill. By the same. 1 vol. 6s.
- The Queen's Maries**, a Romance of Holyrood. 1 vol. 6s.
- The Interpreter**, a Tale of the War. By the same. 1 vol. 5s.
- TALES from GREEK MYTHOLOGY.** By George W. Cox, M.A. late Scholar of Trin. Coll. Oxon. Second Edition. Square 16mo. 3s. 6d.
- Tales of the Gods and Heroes.** By the same Author. Second Edition. Fcp. 5s.
- Tales of Thebes and Argos.** By the same Author. Fcp. 4s. 6d.

- The WARDEN: a Novel.** By ANTHONY TROLLOPE. Crown 8vo. 3s. 6d.
- Barchester Towers: a Sequel to 'The Warden.'** By the same Author. Crown 8vo. 5s.

Poetry and the Drama.

- SELECT WORKS of the BRITISH POETS;** with Biographical and Critical Prefaces by Dr. AIKIN; with Supplement of more recent Selections by LUCY AIKIN. Medium 8vo. 18s.
- GOETHE'S SECOND FAUST.** Translated by JOHN ANSTER, LL.D. M.R.I.A. Regius Professor of Civil Law in the University of Dublin. Post 8vo. 15s.
- TASSO'S JERUSALEM DELIVERED.** Translated into English Verse by Sir J. KINGSTON JAMES, Kt. M.A. 2 vols. fcp. with Facsimile, 14s.
- POETICAL WORKS of JOHN EDMUND READE;** with final Revision and Additions. 3 vols. fcp. 18s. or each vol. separately, 6s.
- MOORE'S POETICAL WORKS,** Cheapest Editions complete in 1 vol. including the Autobiographical Prefaces and Author's last Notes, which are still copyright. Crown 8vo. ruby type, with Portrait, 7s. 6d. or People's Edition, in larger type, 12s. 6d.
- Moore's Poetical Works,** as above, Library Edition, medium 8vo. with Portrait and Vignette, 14s. or in 10 vols. fcp. 3s. 6d. each.
- TENNIEL'S EDITION of MOORE'S LALLA ROOKH,** with 68 Wood Engravings from original Drawings and other Illustrations. Fcp. 4to. 21s.
- Moore's Lalla Rookh.** 32mo. Plate, 1s. 16mo. Vignette, 2s. 6d.
- MACLISE'S EDITION of MOORE'S IRISH MELODIES,** with 161 Steel Plates from Original Drawings. Super-royal 8vo. 31s. 6d.
- Moore's Irish Melodies,** 32mo. Portrait, 1s. 16mo. Vignette, 2s. 6d.
- SOUTHEY'S POETICAL WORKS,** with the Author's last Corrections and copyright Additions. Library Edition, in 1 vol. medium 8vo. with Portrait and Vignette, 14s. or in 10 vols. fcp. 3s. 6d. each.
- LAYS of ANCIENT ROME;** with *Ivry* and the *Armada*. By the Right Hon. LORD MACAULAY. 16mo. 4s. 6d.
- Lord Macaulay's Lays of Ancient Rome.** With 90 Illustrations on Wood, Original and from the Antique, from Drawings by G. SCHARF. Fcp. 4to. 21s.
- POEMS.** By JEAN INGELow. Ninth Edition. Fcp. 8vo. 5s.

POETICAL WORKS of LETITIA ELIZABETH LONDON (L.E.L.)

2 vols. 16mo. 10s.

PLAYTIME with the POETS: a Selection of the best English Poetry for the use of Children. By a LADY. Crown 8vo. 5s.**BOWDLER'S FAMILY SHAKSPEARE**, cheaper Genuine Edition, complete in 1 vol. large type, with 36 Woodcut Illustrations, price 14s. or with the same ILLUSTRATIONS, in 6 pocket vols. 3s. 6d. each.**ARUNDINES CAMI**, sive Musarum Cantabrigiensium Lusum canonicum. Collegit atque edidit H. DEBURY, M.A. Editio Sexta, curavit H. J. HODGSON, M.A. Crown 8vo. 7s. 6d.*Rural Sports, &c.***ENCYCLOPEDIA of RURAL SPORTS**; a complete Account, Historical, Practical, and Descriptive, of Hunting, Shooting, Fishing, Racing, &c. By D. P. BLAINE. With above 600 Woodcuts (20 from Designs by JOHN LEECH). 8vo. 42s.**NOTES on RIFLE SHOOTING**. By Captain HEATON, Adjutant of the Third Manchester Rifle Volunteer Corps. Fcp. 2s. 6d.**COL. HAWKER'S INSTRUCTIONS to YOUNG SPORTSMEN** in all that relates to Guns and Shooting. Revised by the Author's SON. Square crown 8vo. with Illustrations, 18s.**The DEAD SHOT**, or Sportsman's Complete Guide; a Treatise on the Use of the Gun, Dog-breaking, Pigeon-shooting, &c. By MARKSMAN. Fcp. 8vo. with Plates, 5s.**The FLY-FISHER'S ENTOMOLOGY**. By ALFRED RONALDS. With coloured Representations of the Natural and Artificial Insect. Sixth Edition; with 20 coloured Plates. 8vo. 14s.**HANDBOOK of ANGLING**: Teaching Fly-fishing, Trolling, Bottom-fishing, Salmon-fishing; with the Natural History of River Fish, and the best modes of Catching them. By EPHEMERA. Fcp. Woodcuts, 6s.**The CRICKET FIELD**; or, the History and the Science of the Game of Cricket. By JAMES PYCROFT, B.A. Trin. Coll. Oxon. Fourth Edition. Fcp. 5s.**The Cricket Tutor**; a Treatise exclusively Practical. By the same. 18mo. 1s.**Cricketana**. By the same Author. With 7 Portraits of Cricketers. Fcp. 5s.**The HORSE'S FOOT**, and **HOW to KEEP IT SOUND**. By W. MILES, Esq. Ninth Edition, with Illustrations. Imp. 8vo. 12s. 6d.**A Plain Treatise on Horse-Shoeing**. By the same Author. Post 8vo. with Illustrations, 2s. 6d.**Stables and Stable-Fittings**. By the same. Imp. 8vo. with 13 Plates, 15s.**Remarks on Horses' Teeth**, addressed to Purchasers. By the same. Post 8vo. 1s. 6d.

- DRILL and MANŒUVRES of CAVALRY**, combined with Horse Artillery. By Major-Gen. MICHAEL W. SMITH, C.B. Commanding the Poonah Division of the Bombay Army. 8vo. 12s. 6d.
- the HORSE**: with a Treatise on Draught. By WILLIAM YOUATT. New Edition, revised and enlarged. 8vo. with numerous Woodcuts, 10s. 6d.
- the Dog**. By the same Author. 8vo. with numerous Woodcuts, 6s.
- the DOG in HEALTH and DISEASE**. By STONEHENGE. With 70 Wood Engravings. Square crown 8vo. 15s.
- the Greyhound in 1864**. By the same Author. With 24 Portraits of Greyhounds. Square crown 8vo. 21s.
- the OX**; his Diseases and their Treatment: with an Essay on Parturition in the Cow. By J. R. DOBSON, M.R.C.V.S. Crown 8vo. with Illustrations. price 7s. 6d.

Commerce, Navigation, and Mercantile Affairs.

- the LAW of NATIONS** Considered as Independent Political Communities. By TRAVERS TWISS, D.C.L. Regius Professor of Civil Law in the University of Oxford. 2 vols. 8vo. 30s. or separately, PART I. *Peace*, 12s. PART II. *War*, 18s.
- NAUTICAL DICTIONARY**, defining the Technical Language relative to the Building and Equipment of Sailing Vessels and Steamers, &c. By ARTHUR YOUNG. Second Edition; with Plates and 150 Woodcuts. 8vo. 18s.
- DICTIONARY**, Practical, Theoretical, and Historical, of Commerce and Commercial Navigation. By J. R. M'CULLOCH, Esq. 8vo. with Maps and Plans, 50s.
- the STUDY of STEAM and the MARINE ENGINE**, for Young Sea Officers. By S. M. SAXBY, R.N. Post 8vo. with 87 Diagrams, 5s. 6d.
- MANUAL for NAVAL CADETS**. By J. M'NEIL BOYD, late Captain R.N. Third Edition; with 240 Woodcuts and 11 coloured Plates. Post 8vo. 12s. 6d.

Works of Utility and General Information.

- MODERN COOKERY for PRIVATE FAMILIES**, reduced to a System of Easy Practice in a Series of carefully-tested Receipts. By ELIZA ACTON. Newly revised and enlarged; with 8 Plates, Figures, and 150 Woodcuts. Fcp. 7s. 6d.
- the HANDBOOK of DINING**; or, Corpulency and Leanness scientifically considered. By BRILLAT-SAVARIN, Author of 'Physiologie du Goût.' Translated by L. F. SIMPSON. Revised Edition, with Additions. Fcp. 3s. 6d.

- On **FOOD and its DIGESTION**; an Introduction to Dietetics. By W. BRINTON, M.D. Physician to St. Thomas's Hospital, &c. With 48 Woodcuts. Post 8vo. 12s.
- WINE, the VINE, and the CELLAR.** By THOMAS G. SHAW. Second Edition, revised and enlarged, with Frontispiece and 31 Illustrations on Wood. 8vo. 16s.
- A PRACTICAL TREATISE on BREWING**; with Formulae for Public Brewers, and Instructions for Private Families. By W. BLACK. 8vo. 10s. 6d.
- SHORT WHIST.** By MAJOR A. Sixteenth Edition, revised, with an Essay on the Theory of the Modern Scientific Game by PROF. P. Fcp. 3s. 6d.
- WHIST, WHAT TO LEAD.** By CAM. Second Edition. 32mo. 1s.
- HINTS on ETIQUETTE and the USAGES of SOCIETY**; with a Glance at Bad Habits. Revised, with Additions, by a LADY of RANK. Fcp. price 2s. 6d.
- The CABINET LAWYER**; a Popular Digest of the Laws of England Civil and Criminal. Twentieth Edition, extended by the Author; including the Acts of the Sessions 1863 and 1864. Fcp. 10s. 6d.
- The PHILOSOPHY of HEALTH**; or, an Exposition of the Physiological and Sanitary Conditions conducive to Human Longevity and Happiness. By SOUTHWOOD SMITH, M.D. Eleventh Edition, revised and enlarged: with 113 Woodcuts, 8vo. 15s.
- HINTS to MOTHERS on the MANAGEMENT of their HEALTH** during the Period of Pregnancy and in the Lying-in Room. By T. BRUCE, M.D. Fcp. 5s.
- The Maternal Management of Children in Health and Disease.** By the same Author. Fcp. 5s.
- NOTES on HOSPITALS.** By FLORENCE NIGHTINGALE. Third Edition, enlarged; with 13 Plans. Post 4to. 18s.
- C. M. WILLICH'S POPULAR TABLES** for ascertaining the Value of Lifehold, Leasehold, and Church Property, Renewal Fines, &c.: the Public Funds; Annual Average Price and Interest on Consols from 1731 to 1861; Chemical, Geographical, Astronomical, Trigonometrical Tables, &c. Post 8vo. 10s.
- THOMSON'S TABLES of INTEREST**, at Three, Four, Four and Half, and Five per Cent. from One Pound to Ten Thousand and from 1 to 365 Days. 12mo. 3s. 6d.
- MAUNDER'S TREASURY of KNOWLEDGE and LIBRARY** of Reference: comprising an English Dictionary and Grammar, Universal Gazetteer, Classical Dictionary, Chronology, Law Dictionary, a Synopsis of the Peerage, useful Tables, &c. Fcp. 10s.

INDEX.

	PAGE		PAGE
BOTT on Sight and Touch	10	BOCKLE's History of Civilization	2
TON's Modern Cookery	27	BULL's Hints to Mothers	28
KIN's Select British Poets	25	Maternal Management of Children	28
Memoirs and Remains	4	BUNSEN's Analecta Ante-Nicensa	20
COCK's Residence in Japan	23	Ancient Egypt	3
LINES on Formation of Christianity	19	Hippolytus and his Age	20
pine Guide (The)	22	Philosophy of Universal History	20
JOHN's Manual of the Metalloids	12	BUNSEN on Apocrypha	20
LAGO's Biographies of Scientific Men	5	BUNYAN's Pilgrim's Progress, illustrated by	
Popular Astronomy	10	BENNETT	16
Meteorological Essays	10	BURKE's Vicissitudes of Families	5
INOLD's Manual of English Literature	7	BURTON's Christian Church	3
TWOTT's Elements of Physics	11	Cabinet Lawyer	28
undines Carni	26	CALVERT's Wife's Manual	21
herstone Priory	24	Campaigner at Home	9
KINSON's Papinian	5	CATS and FARLIN's Moral Emblems	16
Autumn holidays of a Country Parson	8	Chorale Book for England	21
AR's Treasury of Bible Knowledge	19	COLERIDGE (Bishop) on Pentateuch and Book	
of Joshua	19	COLUMBUS's Voyages	23
BRADSHAW's Life of a Philosopher	4	Commonplace Philosopher in Town and	
Essays, by WHATELY	5	Country	8
Life and Letters, by SPEDDING	4	CONINGTON's Handbook of Chemical Ana-	
Works, by ELLIS, SPEDDING, and		lysis	14
HEATE	6	CONTANSEAU's Pocket French and English	
IN on the Emotions and Will	10	Dictionary	8
on the Senses and Intellect	10	Practical ditto	8
on the Study of Character	10	CONYBEARE and HOWSON's Life and Epistles	
INNE's Explorations in S. W. Africa	22	of St. Paul	18
LL's Guide to the Central Alps	23	COOK's Voyages	23
Guide to the Western Alps	23	COPLAND's Dictionary of Practical Medicine	
YLDON's Rents and Tillages	18	Abridgment of ditto	15
ACK's Treatise on Brewing	26	COX's Tales of the Great Persian War	2
ACKLEY and FRIEDLANDER's German and		Tales from Greek Mythology	24
English Dictionary	8	Tales of the Gods and Heroes	24
AINE's Rural Sports	26	Tales of Thebes and Argos	25
IGHT's Week at the Land's End	22	CRESY's Encyclopaedia of Civil Engineering	
UNNEY's Alps of Dauphiné	22	Critical Essays of a Country Parson	8
UNNEY's Catechism of the Steam Engine	17	CROWE's History of France	2
Handbook of Steam Engine	17	D'AUBIGNON's History of the Reformation in	
Treatise on the Steam Engine	17	the time of CALVIN	2
WDLER's Family SHAKESPEARE	26	Dead Shot (The), by MARSHMAN	26
YD's Manual for Naval Cadets	27	DE LA RIVE's Treatise on Electricity	12
AMLEY-MOORE's Six Sisters of the Valleys		DELMAR's Village Life in Switzerland	22
ANDER'S Dictionary of Science, Literature,		DE LA FRYME's Life of Christ	20
and Art	18	DE TOCQUEVILLE's Democracy in America	2
LAY'S (C.) Education of the Feelings	10	Diaries of a Lady of Quality	4
Philosophy of Necessity	10	DONSON on the OX	27
(Mrs.) British Empire	11	DOVE's Law of Storms	11
INTON on Food and Digestion	26	DOYLE's Chronicle of England	2
ISTOW's Glossary of Mineralogy	12	Ellice, a Tale	24
ODIE'S (Sir C. B.) Psychological Inquiries		ELLICOTT's Broad and Narrow Way	19
Works	15	Commentary on Ephesians	19
Autobiography	15	Destiny of the Creature	19
OWNE's Ice Caves of France and Switzer-		Lectures on Life of Christ	19
and	22		
Exposition 39 Articles	18		
Pentateuch	18		

	PAGE		
ELICOTT's Commentary on Galatians.....	19	Hunting Grounds of the Old World.....	
----- Pastoral Epist.....	19	Hymns from <i>Lyra Germanica</i>	
----- Philippians, &c.....	19		
----- Thessalonians.....	19	INGKLOW's Poems.....	
ESSAYS and REVIEWS.....	20		
on Religion and Literature, edited		JAMESON's Legends of the Saints and Mar-	
by MANNING.....	20	tyrs.....	
written in the Intervals of Business	9	Legends of the Madonnas.....	
		Legends of the Monastic Orders.....	
FAIRBAIRN's Application of Cast and		JAMESON and EASTLAKE's History of Our	
Wrought Iron to Building.....	17	Lord.....	
Information for Engineers.....	17	JONES's Home Walks and Holiday Rambles	
Treatise on Mills & Millwork.....	17	JONSON's Patience's Manual.....	
FYOLKES's Christendom's Divisions.....	20	Practical Draughtsman.....	
First Friendship.....	24	JOHNSTON's Gazetteer, or Geographical Dic-	
FITZ ROY's Weather Book.....	11	tionary.....	
FOWLER's Collieries and Colliers.....	17	JONES's Christianity and Common Sense.....	
FRESHFIELD's Alpine Byways.....	23		
Tour in the Grisons.....	23	KALISCH's Commentary on the Old Testa-	
Friends in Council.....	9	ment.....	
FROUDE's History of England.....	1	Hebrew Grammar.....	
		KENNEDY's Hymnologia Christiana.....	
GARRATT's Marvels and Mysteries of		KISTEVEN's Domestic Medicine.....	
Instinct.....	18	KIRBY and SPENCE's Entomology.....	
GRAY's Sunday to Sunday.....	21	KNAIGHTON's Story of Elihu Jan.....	
Geological Magazine.....	12	KOBLER's Notes to <i>Lyra Germanica</i>	
GILBERT and CURRIE's Dolomite Moun-		KUMEN on Pentateuch and Joshua.....	
tains.....	23		
GILLY's Shipwrecks of the Navy.....	23	Lady's Tour Round Monte Rosa.....	
GORTAL'S Second Faust, by ANSTER.....	25	LANDON's (L. E. L.) Poetical Works.....	
GOODEY's Elements of Mechanism.....	16	Late Laurels.....	
GORLE's Questions on BROWNE's Exposition		LATHAM's English Dictionary.....	
of the 39 Articles.....	18	LECKY's History of Rationalism.....	
GRAVEY Thoughts of a Country Parson.....	8	Leisure Hours in Town.....	
GRAY's Anatomy.....	15	LEWIS's Biographical History of Philosophy	
GREENE's Corals and Sea Jellies.....	12	LEWIS on the Astronomy of the Ancients.....	
Sponges and Animalcules.....	12	on the Credibility of Early Roman	
GROVE on Correlation of Physical Forces..	12	History.....	
GWILT's Encyclopædia of Architecture.....	16	Dialogue on Government.....	
		on Egyptological Method.....	
		Essays on Administrations.....	
		Fables of BARRIUS.....	
		on Foreign Jurisdiction.....	
		on Irish Disturbances.....	
		on Observation and Reasoning in	
		Politics.....	
		on Political Terms.....	
		on the Romance Language.....	
Handbook of Angling, by EPHEMERA.....	26	LUDELL and SCOTT's Greek-English Lexicon	
HARE on Election of Representatives.....	7	Abridged into.....	
HARTWIG's Sea and its Living Wonders....	12	LENDLEY and MOORE's Treasury of English	
Tropical World.....	12	Landscape.....	
HAWKER's Instructions to Young Sportsmen	26	LONGMAN's Lectures on the History of Eng-	
HEATON's Notes on Rifle Shooting.....	26	land.....	
HELPS's Spanish Conquest in America.....	2	LODGE's Encyclopædia of Agriculture.....	
HERSCHEL's Essays from the Edinburgh		Cottage, Farm,	
and Quarterly Reviews.....	13	and Villa Architecture.....	
Outlines of Astronomy.....	10	Gardening.....	
HEWITT on the Diseases of Women.....	14	Plants.....	
HINCHLIFF's South American Sketches.....	22	Trees & Shrubs.....	
HINTS on Etiquette.....	28	LOWMEYER's Engineer's Handbook.....	
HOBSON's Time and Space.....	10	LYRA Domestica.....	
HOLLAND's Chapters on Mental Physiology	9	Eucharistica.....	
Essays on Scientific Subjects.....	13	Germanica.....	
Medical Notes and Reflections.....	15	Messianica.....	
HOLMES's System of Surgery.....	14	Mystica.....	
HOOKER and WALKER-ARNOTT's British		Sacra.....	
Flora.....	13		
HORNE's Introduction to the Scriptures.....	19	MACAULAY's (Lord) Essays.....	
Compendium of ditto.....	19	History of England.....	
HOSKYN'S Talpa.....	17	Lays of Ancient Rome.....	
How We Spent the Summer.....	22	Miscellaneous Writings.....	
HOWITT's Australian Discovery.....	23	Speeches.....	
History of the Supernatural.....	9	Speeches on Parliamentary	
Rural Life of England.....	23	Reform.....	
Visits to Remarkable Places.....	23	MACDOUGALL's Theory of War.....	
HOWSON's Hulsean Lectures on St. Paul....	18	MANSHAM's Life of Havelock.....	
HUGHES's (W.) Geography of British His-			
tory.....	11		
Manual of Geography.....	11		
HULLAN's History of Modern Music.....	4		
Transition Musical Lectures.....	4		
HUMPHREYS's Sentiments of Shakspeare....	16		

5
25
110
4





This book should be returned to the Library on or before the last date stamped below.

A fine of five cents a day is incurred by retaining it beyond the specified time.

Please return promptly.

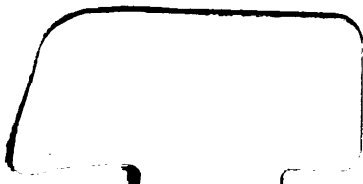

Eng 2698.65.4

A catechism of the steam engine in

Cabot Science

004122265



3 2044 091 964 338